

CC 8800-1

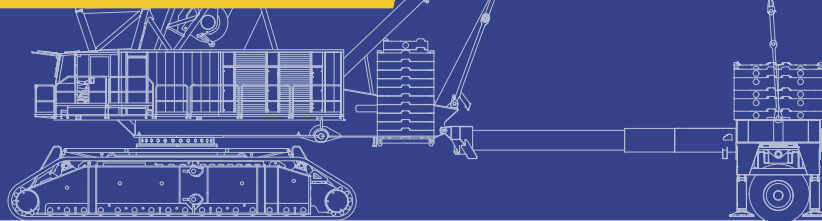











**Crawler Crane
1600 t Capacity**



DEMAG[®]
TADANO GROUP

	Page · Seite · Page · Pagina · Página · Página · Страница:
Specifications · Technische Daten · Caractéristiques · Dati tecnici · Datos técnicos · Especificações · Технические характеристики	5
Superlift configurations · Superlift-Konfigurationen · Combinaisons Superlift · Configurazioni Superlift · Configuraciones Superlift · Configurações do Superlift · Варианты конфигурации суперлифт.....	9
Specifications · Technische Daten · Caractéristiques · Dati tecnici · Datos técnicos · Especificações · Технические характеристики	10
Boom combinations · Ausleger-Kombinationen · Combinaisons de flèche · Combinazioni braccio · Combinaciones de pluma · Combinações de lanças · Комбинации стрелы	12
Main boom with SL · Hauptausleger mit SL · Flèche principale avec SL · Braccio base con SL · Pluma principal con SL · Lança principal com SL · Главная стрела с SL (SSL, HSSL, SSL/LSL).....	14
Fixed fly jib with SL · Starrer Hilfsausleger mit SL · Fléchette fixe avec SL · Falcone fisso con SL · Plumín fijo con SL · Lança auxiliar fixa com SL · неподвижная стрела с изменяемым вылетом с SL (SSL/LSL+LF S2).....	18
Luffing fly jib with SL · Wippbarer Hilfsausleger mit SL · Fléchette à volée variable avec SL · Falcone a volata variabile con SL · Plumín abatible con SL · Jib de lance variável com SL · Стрела с изменяемым углом вылета и гуськом с SL (SWSL / SFSL)	20
Fixed fly jib with SL · Starrer Hilfsausleger mit SL · Fléchette fixe avec SL · Falcone fisso con SL · Plumín fijo con SL · Lança auxiliar fixa com SL · неподвижная стрела с изменяемым вылетом с SL (SFVL)	62
Technical description · Technische Beschreibung · Descriptif technique · Descrizione tecnica · Descripción técnica · Descrição técnica · Техническое описание.....	64

Zeichenerklärung · Légende · Leggenda · Leyenda · Legenda · Условные обозначения

	Track · Spur · Voie · Cingolo · Orugas · Esteira · Колея	„D“	
	Counterweight + central ballast (ZB) · Gegen- gewicht + Zentralballast (ZB) · Contrepoids + lest central (ZB) · Contrappeso + zavorra centrale (ZB) · Contrapeso + lastre central (ZB) · Contrapeso + lastro central (ZB) · Противовес + центральный балласт (ZB)	S:	heavy · schwer · lourd · pesante · pesado · pesada · сильный
	Superlift counterweight · Superlift-Gegengewicht · Contrepoids Superlift · Contrappeso Superlift · Contrapeso Superlift · Contrapeso do Superlift · Противовес суперлифт	L:	light · leicht · léger · leggera · ligero · leve · слабый
	Superlift radius · Superlift-Radius · Rayon Superlift · Sbraccio Superlift · Radio de Superlift · Raio do Superlift · Радиус для оборудования суперлифт	H / HA:	Main boom · Hauptausleger · Flèche principale · Braccio principale · Pluma principal · Lança principal · Главная стрела
	Load radius · Lastradius · Portée · Raggio di lavoro · Radio de trabajo · Raio de operação · Рабочий радиус	HI:	Luffing jib · Hilfsausleger · Fléchette · Falcone · Plumín · Lança auxiliar · Стрела с изменяемым вылетом
	Main boom · Hauptausleger · Flèche principale · Braccio principale · Pluma principal · Lança principal · Главная стрела	W:	Luffing fly jib · Wippbarer Hilfsausleger · Fléchette à volée variable · Falcone a volata variabile · Plumín abatible · Jib de lance variável · Стрела с изменяемым углом вылета и гуськом
	Fly jib · Hilfsausleger · Fléchette · Falcone · Plumín · Lança auxiliar · Стрела с изменяемым вылетом	F:	Fixed fly jib · Starrer Hilfsausleger · Fléchette fixe · Falcone fisso · Plumín fijo · Lança auxiliar fixa · Неподвижная стрела с изменяемым вылетом
	Main boom angle · Hauptauslegerwinkel · Jarret de flèche principale · Inclinazione braccio base · Ângulo de pluma principal · Ângulo da lança principal · Угол наклона главной стрелы	SL:	Superlift · Superlift · Levage supplémentaire · Superlift · Superlift · Kit Superlift · Суперлифт (система для увеличения грузоподъемности)
	Fly jib angle · Hilfsauslegerwinkel · Jarret de fléchette · Inclinazione falcone · Ângulo de plumín · Ângulo da lança auxiliar · Угол наклона стрелы с изменяемым вылетом	V:	Vessellift · Vessellift · Vessellift · Vessellift · Vessellift · Içamento de embarcação · Подъем судов
	Wind speed in m/s (meter per second) · Wind- geschwindigkeit in m/s · Vitesse du vent en m/s · Velocità del vento in m/s (metri al secondo) · Velocidad del viento en m/s · Velocidade do vento em m/s (metros por segundo) · Скорость ветра в м/сек	SGL:	Heavy base length · Schwere Grundlänge · Longueur de base lourde · Lunghezza carro in versione pesante · Longitud de base pesada · Comprimento da base pesada · Длина тяжелой базы
			Central ballast · Zentralballast · Lest central · Zavorra centrale · Lastre central · Lastro central · Центральный балласт

- ▶ Max. capacity 1600 t
 - ▶ Max. load moment 26800 mt
 - ▶ Max. hook height 231 m
 - ▶ Superlift radii 19-30 m
 - ▶ Excellent capacities at the luffing fly jib
 - ▶ Redundant drivelines
 - ▶ 400 V power supply
 - ▶ Optional TWIN-Kit for capacities up to 3200 t
 - ▶ Optional Boom Booster Kit
- ▶ Max. Tragfähigkeit 1600 t
 - ▶ Max. Lastmoment 26800 mt
 - ▶ Max. Hakenhöhe 231 m
 - ▶ Superliftradien 19-30 m
 - ▶ Ausgezeichnete Tragfähigkeiten am wippbaren Hilfsausleger
 - ▶ Redundante Antriebseinheiten
 - ▶ 400 V Stromaggregat
 - ▶ Optionales TWIN-Kit für Tragfähigkeiten bis 3200 t
 - ▶ Optionales Boom Booster Kit
- ▶ Capacité maximale de 1600 t
 - ▶ Couple de charge max. 26800 tm
 - ▶ Hauteur du crochet max. de 231 m
 - ▶ Radius superlift 19-30 m
 - ▶ Excellentes capacités avec la volée variable
 - ▶ Double unité d'entraînement
 - ▶ Groupe électrogène de 400 V
 - ▶ En option le kit TWIN pour des capacités jusqu'à 3200 t
 - ▶ En option le kit Boom Booster
- ▶ Capacità max 1600 t
 - ▶ Momento di carico massimo 26800 tm
 - ▶ Altezza gancio max 231 m
 - ▶ Portata Superlift 19-30 m
 - ▶ Eccellente capacità del falcone a volata variabile
 - ▶ Trasmmissione ridondante
 - ▶ Alimentazione 400 V
 - ▶ TWIN-Kit opzionale per capacità fino a 3200 t
 - ▶ Boom Booster-Kit opzionale
- ▶ Máx. capacidad 1600 t
 - ▶ Momento de carga máx. 26800 tm
 - ▶ Máx. altura del gancho 231 m
 - ▶ Radios Superlift 19-30 m
 - ▶ Excelentes capacidades en el plumín abatible
 - ▶ Transmisiones redundantes
 - ▶ Suministro de energía de 400 V
 - ▶ Kit TWIN opcional para capacidades hasta 3200 t
 - ▶ Kit Boom Booster opcional
- ▶ Capacidade máx. de 1600 t
 - ▶ Momento de carga máx. 26800 toneladas
 - ▶ Altura do gancho máx. 231 m
 - ▶ Raios da Superlift 19-30 m
 - ▶ Excelentes capacidades na lança auxiliar articulada
 - ▶ Sistemas de tração redundantes
 - ▶ Fonte de alimentação de 400 V
 - ▶ Kit de lança dupla opcional para capacidades de até 3200 t
 - ▶ Kit de Boom Booster opcional
- ▶ макс. грузоподъемностью 1600 т
 - ▶ Макс. момент нагрузки 26800 мт
 - ▶ Макс. высота подъема крюка 231 м
 - ▶ Радиус системы суперлифт 19-30 м
 - ▶ Отличная грузоподъемность гуська с механизмом подъема
 - ▶ Резервные линии привода
 - ▶ Питание 400 В
 - ▶ Дополнительный комплект TWIN-Kit для мощностей до 3200 т
 - ▶ Дополнительный комплект Boom Booster-Kit



Technische Daten · Caractéristiques · Dati tecnici ·
Datos técnicos · Especificações · Технические характеристики

**Working speeds (infinitely variable) · Arbeitsgeschwindigkeiten (stufenlos regelbar) ·
Vitesses de travail (réglables sans paliers) · Rapporti di lavoro (a regolazione continua) ·
Velocidades de trabajo (progresión continua) · Velocidades de trabalho (infinitamente
variáveis) · Рабочие скорости (с бесступенчатой регулировкой)**

Mechanism Antrieb Mécanisme Funzioni Mecanismos Mecanismo Механизм	Rope ø Seil-ø ø du câble ø fune ø cable Diâm. cabo Диаметр троса	Speeds ¹⁾ Geschwindigkeiten ¹⁾ Vitesses ¹⁾ Rapporti ¹⁾ Velocidades ¹⁾ Velocidades ¹⁾ Скорости ¹⁾	Single line pull Seilzug je Strang Effort sur brin simple Tiro fune singolo Tracción de cable simple Tração de linha simples Тяговое усилие на одиночном тросе	Length of hoist rope Länge des Hubseils Longueur du câble de levage Lungh. della fune dell'argano Long. de cable de cabrestante Compr. do cabo do guincho Длина троса
Hoist I+II · Hubwerk I+II · Treuil de levage I+II · Argano I+II · Cabrestante I+II · Guincho I+II · подъем I+II	(H1+H2) 40 mm	max. 120 m / min	352 kN	1540 m
Runner winch R – option · Runnerwinde R – Option · Tambour potence R – option · Argano runner R – opzionale · (H3) Cabrestante de runner R – opción · Guincho da ponta de montagem R – opcional · Лебедка подвижного блока R – опция	40 mm	max. 90 m / min	352 kN	760 m
Boom derricking · Wippwerk Hauptausleger · Variation de flèche · Inclinazione del braccio · Descenso de pluma · Inclinação da lança · Подъем стрелы деррик-краном	(W2) 40 mm	max. 120 m / min		
Boom hoist · Einziehwerk · Relevage de flèche · Argano del braccio · Cabrestante de pluma Guincho da lança · Подъем стрелы	(E) 40 mm	max. 40 m / min		
Jib luffing · Wippwerk Hilfs- ausleger · Variation de volée · Sollevamento del braccio · Abatimiento de plumín · Inclinação da lança auxiliar · Изменение вылета стрелы	(W1) 40 mm	max. 105 m / min		
Slewing (rpm) · Drehwerk (U / min) Orientation (tr / mn) · Rotazione (rpm) · Unidad de giro (rpm) · Giro (rpm) · Поворот (rpm)		0 – 0,6 ¹⁾ / min		

¹⁾ top layer · oberste Lage · couches supérieure · avvolgimento superiore · capa superior · camada superior · верхний слой

**Carrier performance · Fahrleistungen · Performances du porteur ·
Prestazioni del carro · Rendimiento del vehículo · Desempenho do veículo ·
Общие характеристики шасси**

1st gear · 1. Gang · 1 ^{ère} vitesse · 1 ^a marcia · 1 ^a marcha · 1 ^a . marcha · 1 ^ª передача	max. 0,4 km/h
2nd gear · 2. Gang · 2 ^{ème} vitesse · 2 ^a marcia · 2 ^a marcha · 2 ^a . marcha · 2 ^ª передача	max. 0,8 km/h

Specifications

CC 8800-1

Technische Daten · Caractéristiques · Dati tecnici ·

Datos técnicos · Especificações · Технические характеристики

Hook block system · Unterflaschensystem · Système de crochet-moufle · Sistema per bozzello · Sistema de bloque de gancho · Sistema de moitão · Система крюкоблока

Type Typ Type Tipo Tipo Tipo Тип	Possible load Mögliche Traglast Charge possible Portata possibile Carga permitida Carga possível Допустимая нагрузка	Number of sheaves Anzahl der Rollen Nombre de poulies Numero di pulegge Total de poleas Número de polias Количество шкивов	Number of lines Strangzahl Nombre de brins No max avvolgim. Reenvíos máx. Número de cabos Кратность троса	Weight Gewicht Poids Peso Peso Peso Вес	„D“
2 x 800	1600 t 800 t 800 t 495 t	2 x 13 2 x 7 1 x 13 1 x 7	2 x 26 2 x 12 2 x 12 1 x 14	44 t 28 t / 18 t 28 t / 18 t 22 t / 8,5 t	8,70 m 6,50 m 6,20 m 6,50 m
2 x 675	1350 t 675 t 675 t 370 t	2 x 10 2 x 5 1 x 10 1 x 5	2 x 21 2 x 11 1 x 21 1 x 11	40 t / 21 t 16 t / 12,5 t 16 t / 12,5 t 14,5 t / 8 t	8,50 m 6,00 m 6,00 m 6,00 m
2 x 200	400 t	2 x 3	2 x 6	20 t / 10 t	6,20 m
100	100 t	1 x 1	1 x 3	7,7 t / 3,7 t	4,50 m

Specifications

CC 8800-1

Technische Daten · Caractéristiques · Dati tecnici ·
Datos técnicos · Especificações · Технические характеристики

Basic crane dimensions · Hauptabmessungen · Dimensions de la grue de base ·
Dimensioni di base della gru · Dimensiones básicas de la grúa · Dimensões do guindaste
básico · Базовые габариты крана

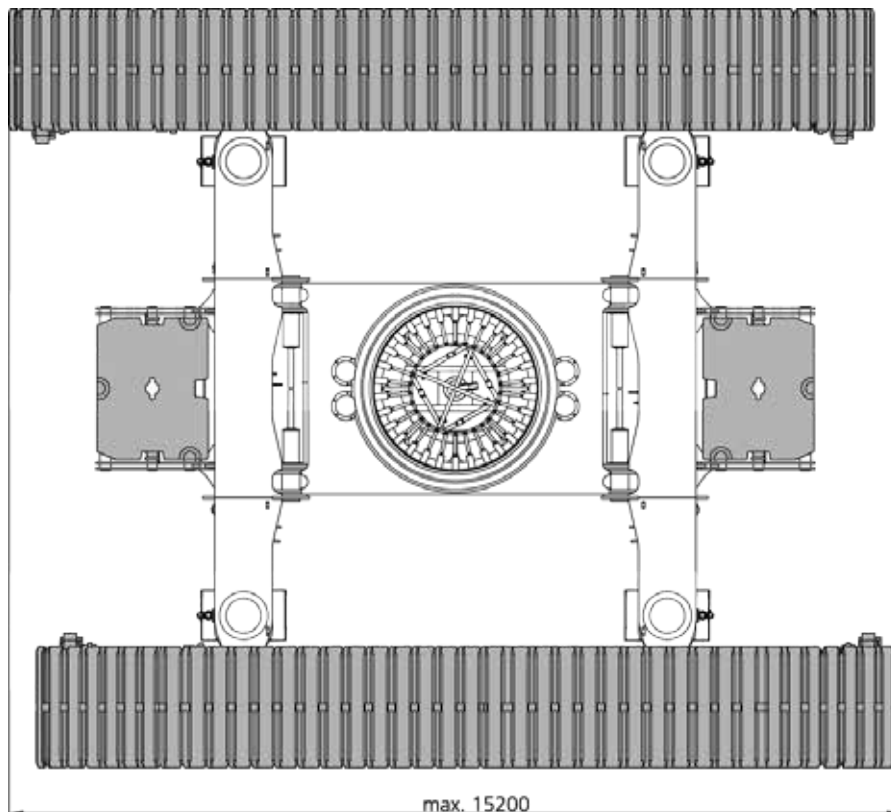
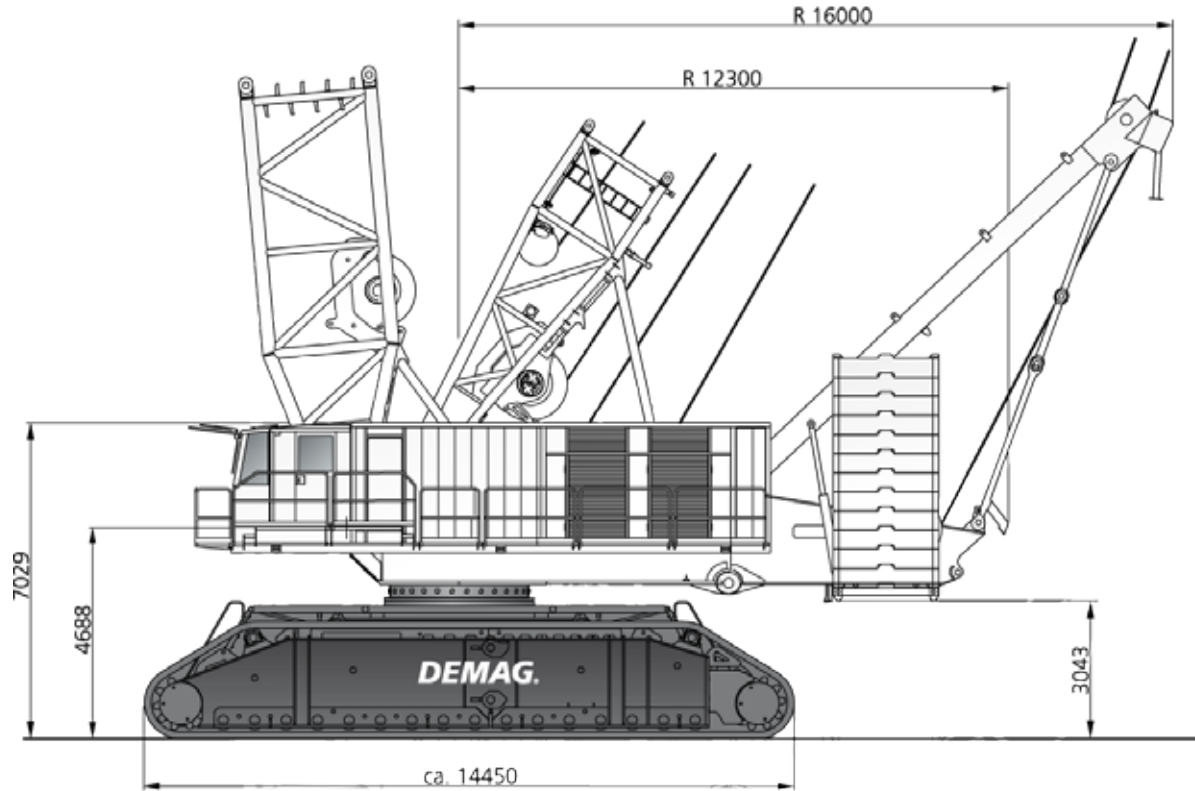

Specifications

CC 8800-1

Technische Daten · Caractéristiques · Dati tecnici ·

Datos técnicos · Especificações · Технические характеристики

Basic crane dimensions · Hauptabmessungen · Dimensions de la grue de base ·

Dimensioni di base della gru · Dimensiones básicas de la grúa · Dimensões do guindaste básico · Базовые габариты крана

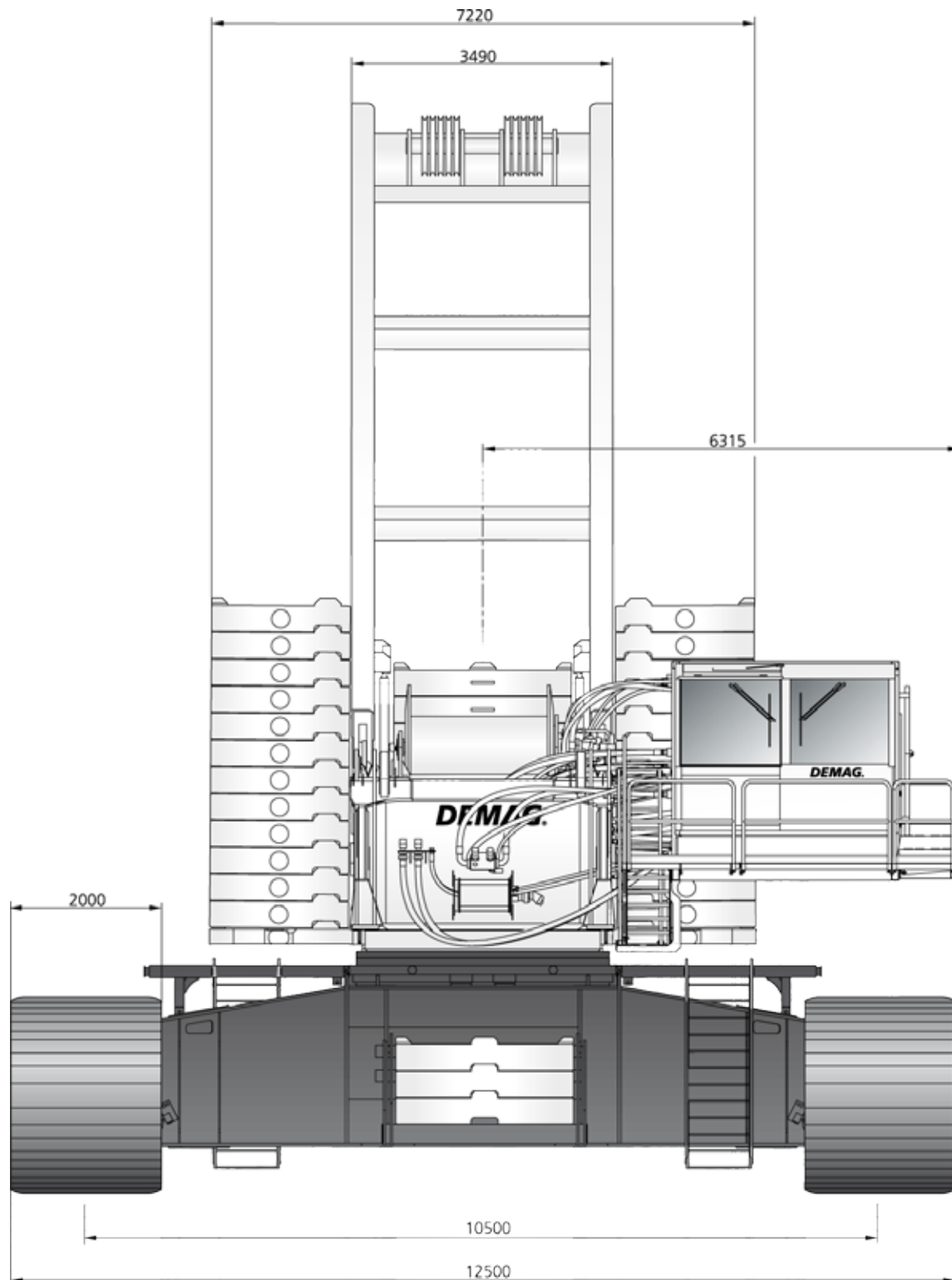

Superlift Configurations

CC 8800-1

Superlift-Konfigurationen · Combinaisons Superlift ·
 Configurazioni Superlift · Configuraciones Superlift ·
 Configurações do Superlift · Варианты конфигурации суперлифт

Tele-SL (Standard · Standard · De série · Di serie · Estándar · Padrão · стандартная комплектация)*

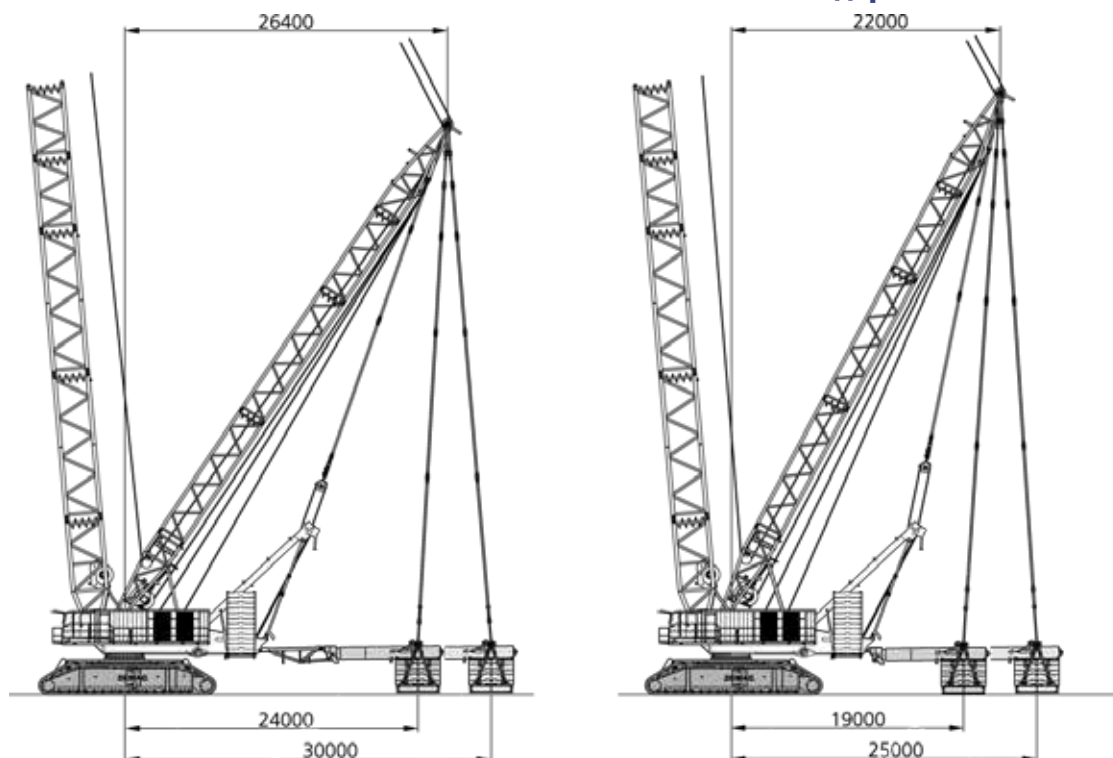

Tele-SL (Wagon, optional · Wagen, optional · Wagon, en option · Supporto, opzionale ·
 Carro, opcional · Veículo, opcional · платформа в качестве дополнительной опции)**

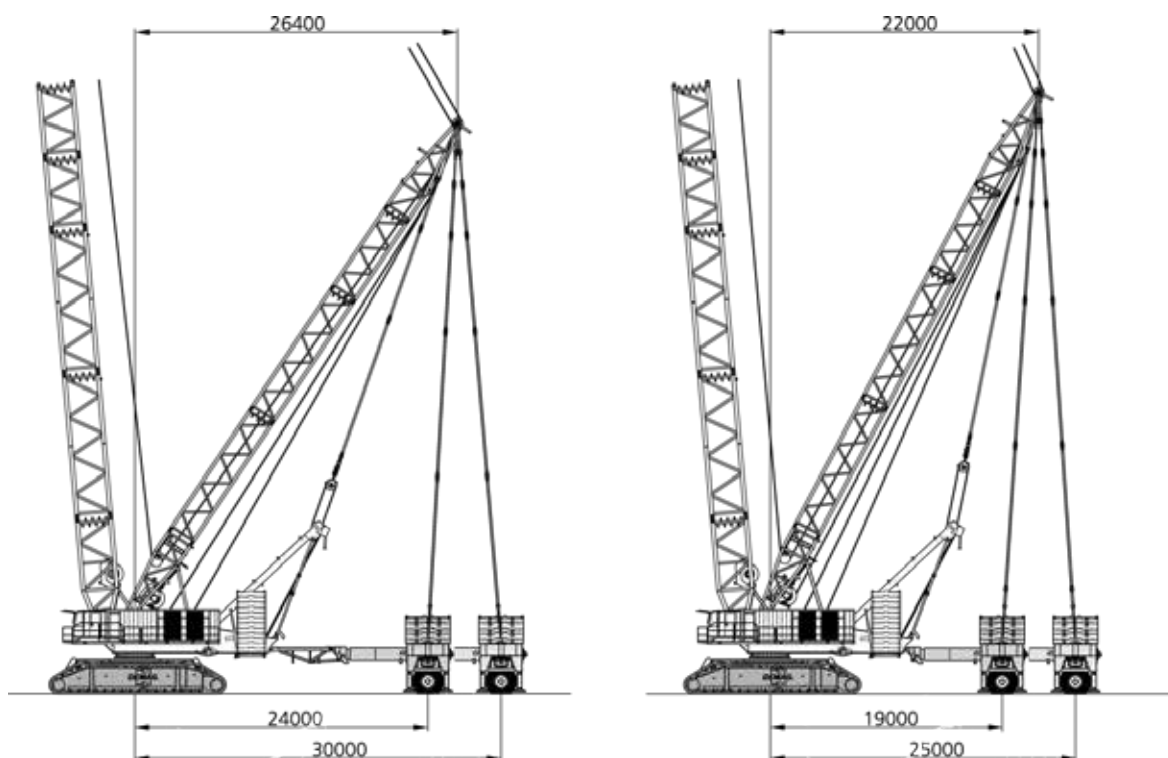

* Standard 640 t (optional 800 t) · Standard 640 t (optional 800 t) · De série en 640 t (en option en 800 t) · Standard 640 t (opzionale 800 t) · Estándar 640 t (opcional 800 t) · Padrão 640 t (opcional 800 t) · стандартная комплектация 640 т (в качестве дополнительной опции 800 т)

** Wagon operates with 640 t (lifting with 800 t possible) · Wagen verfährt mit 640 t (Heben mit 800 t möglich) · Wagon opérationnel en 640 t (levage possible en 800 t) · Il supporto è adatto all'uso con contrappeso di 640 t (consente sollevamenti fino a 800 t) · Carro opera con 640 t (elevación con 800 t posible) · O veículo trabalha com 640 t (içamento com 800 t possível) · платформа работает с 640 т (подъем с 800 т возможен)

Specifications

CC 8800-1

Technische Daten · Caractéristiques · Dati tecnici ·
 Datos técnicos · Especificações · Технические характеристики

Counterweight · Gegengewicht · Contrepoids · Contrappeso · Contrapeso · Contrapeso ·
 Противовес

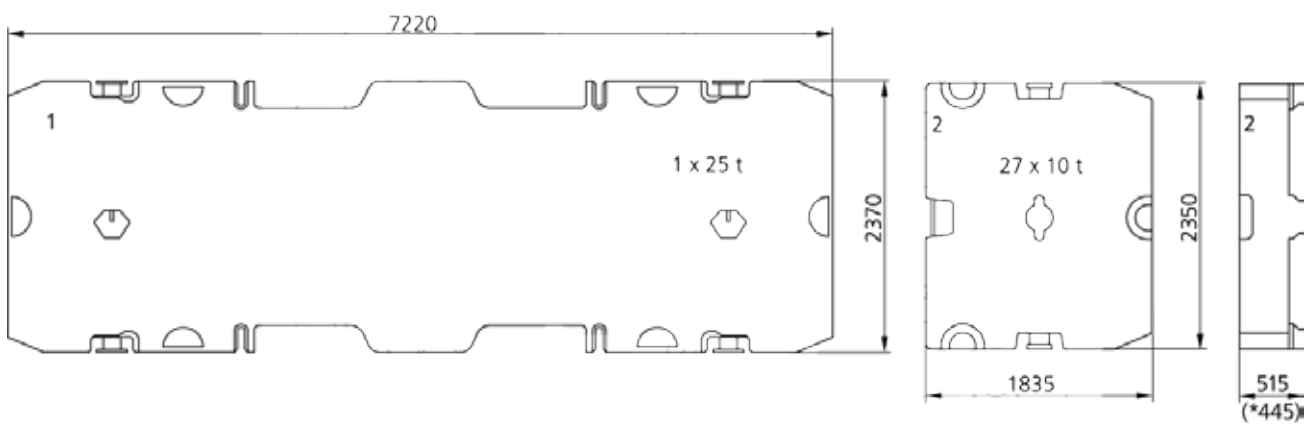
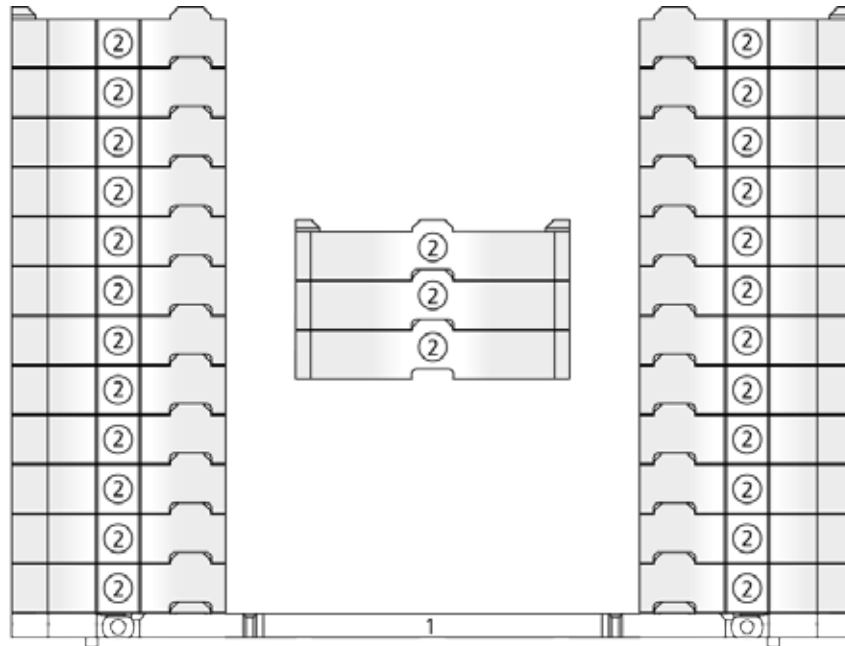

* Option · Option · En option · Opzione · Opcion · Opcional · Опция

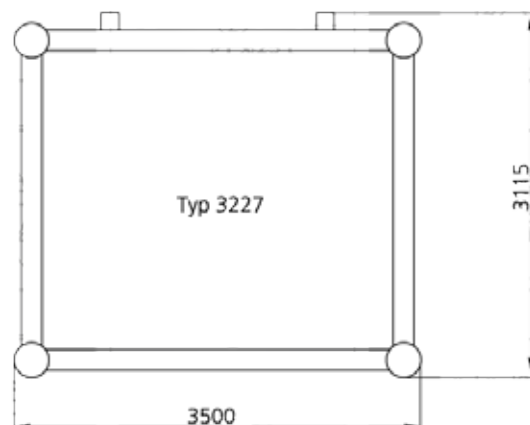

Specifications

CC 8800-1

Technische Daten · Caractéristiques · Dati tecnici ·
 Datos técnicos · Especificações · Технические характеристики

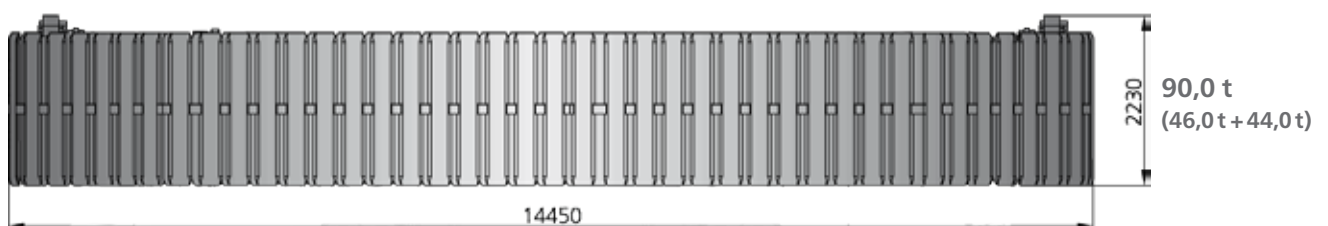
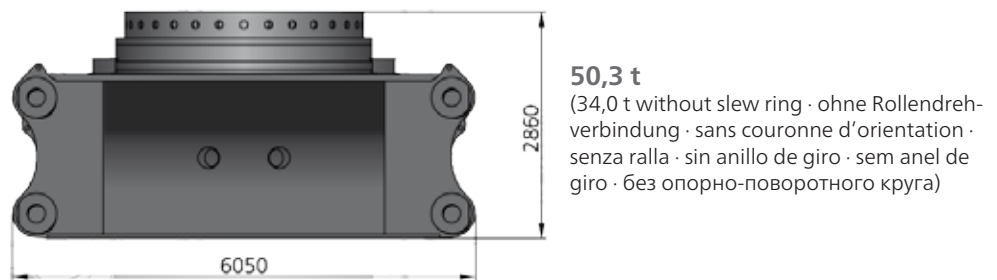
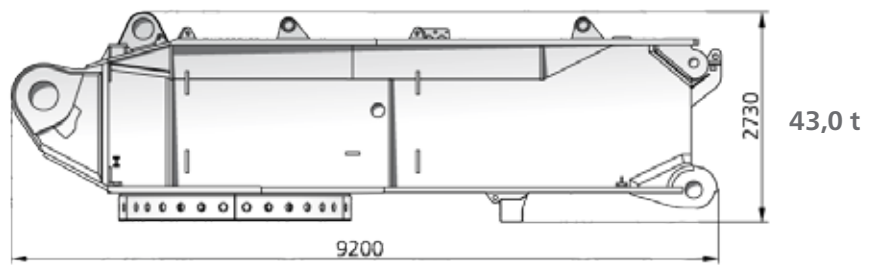
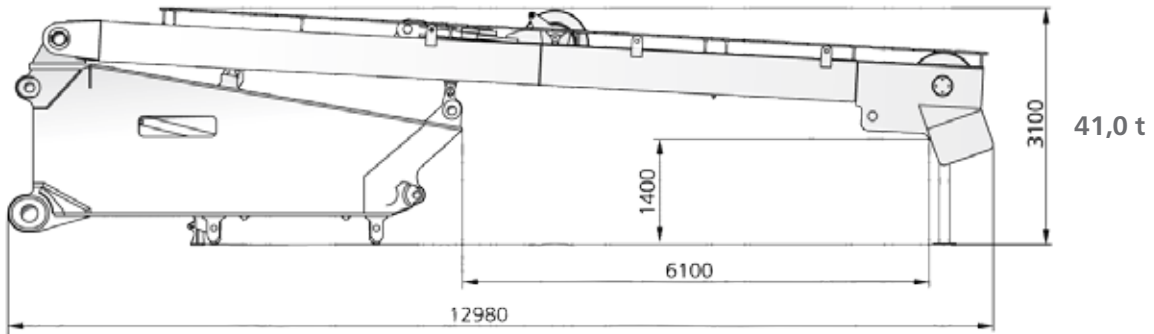

Boom Combinations

CC 8800-1

Ausleger-Kombinationen · Combinaisons de flèche · Combinazioni braccio ·
Combinaciones de pluma · Combinações de lanças · Комбинации стрелы

Runner
max. 100t



SSL, SSL/LSL, SWSL, SFVL

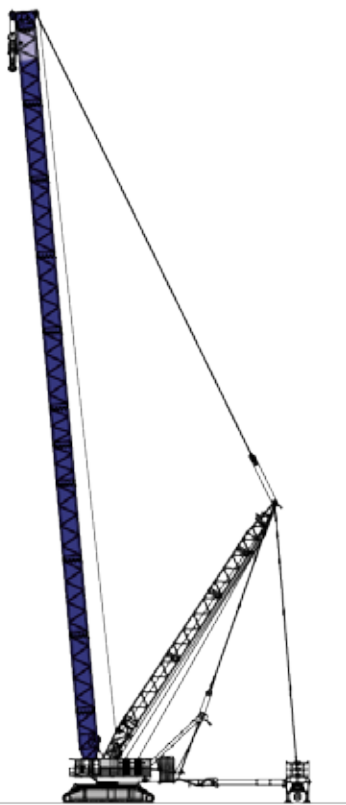

HSSL/SSL
HA 54m ... 84m / 120m

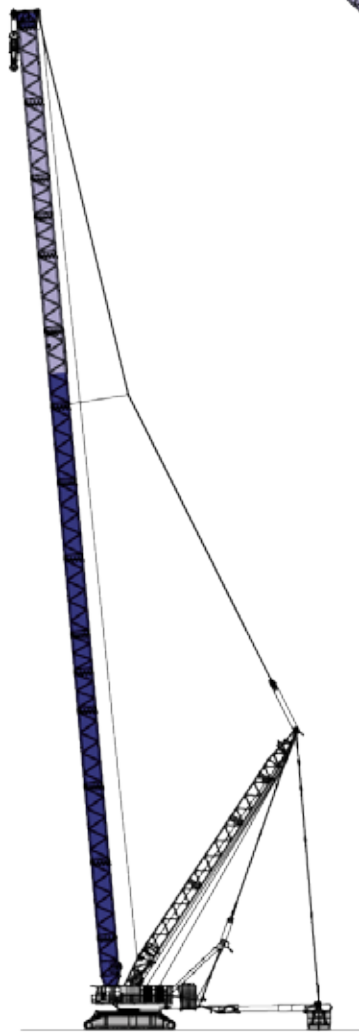

SSL/LSL
HA 114m ... 156m

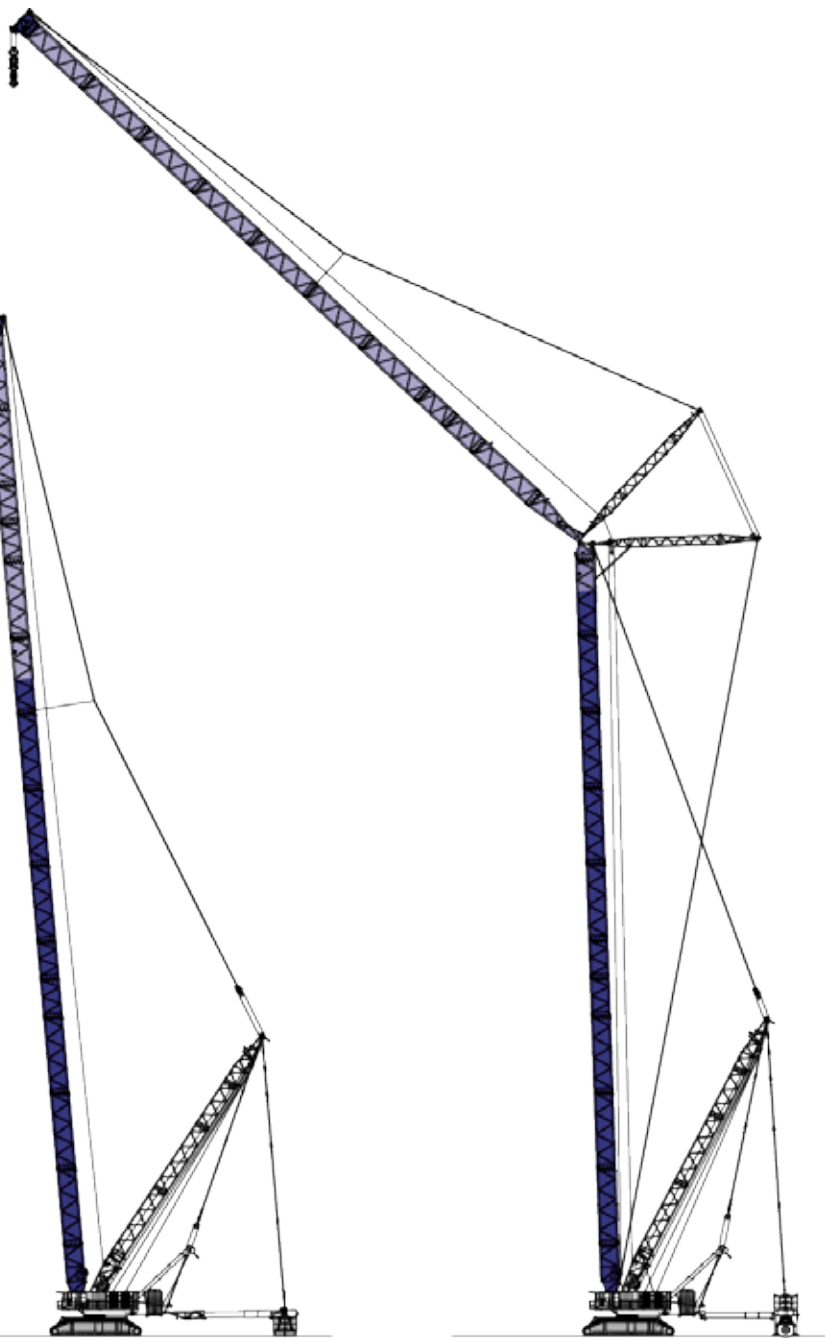

SWSL
HA 54m ... 120m
HI 36m ... 120m

Boom Combinations

CC 8800-1

Ausleger-Kombinationen · Combinaisons de flèche · Combinazioni braccio ·
Combinaciones de pluma · Combinações de lanças · Комбинации стрелы

Runner
max. 100t



SSL, SSL/LSL, SWSL, SFVL

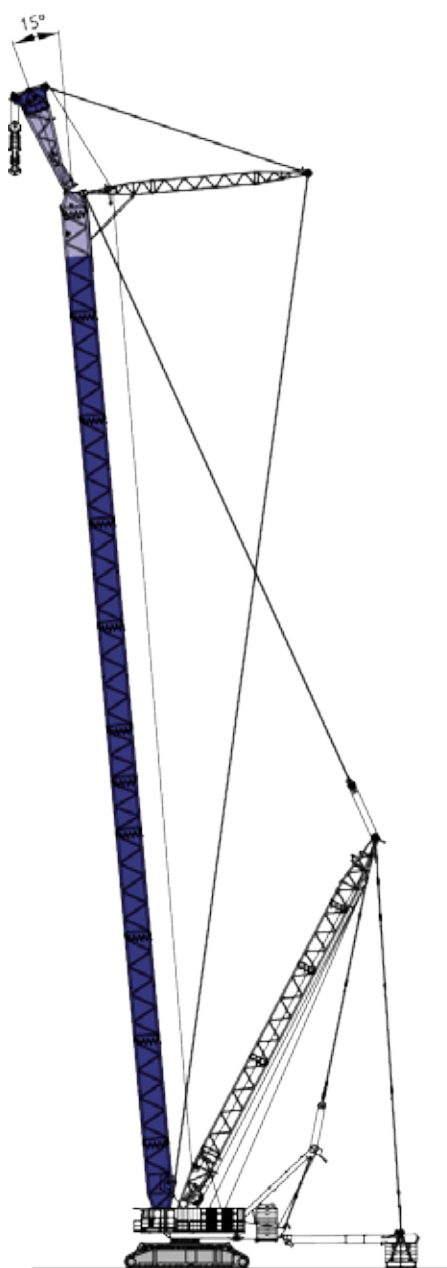

SFVL
HA 54m ... 120m
HI 12m

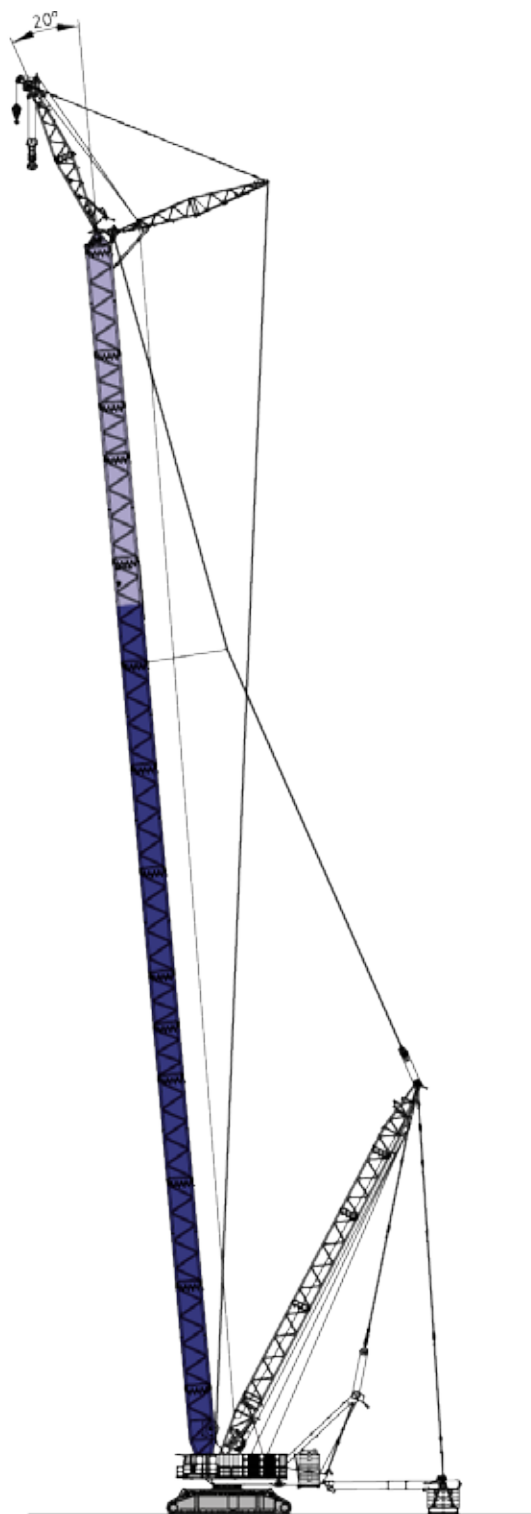

SSL/LSL+LF S2
HA 114m ... 144m
HI 18m

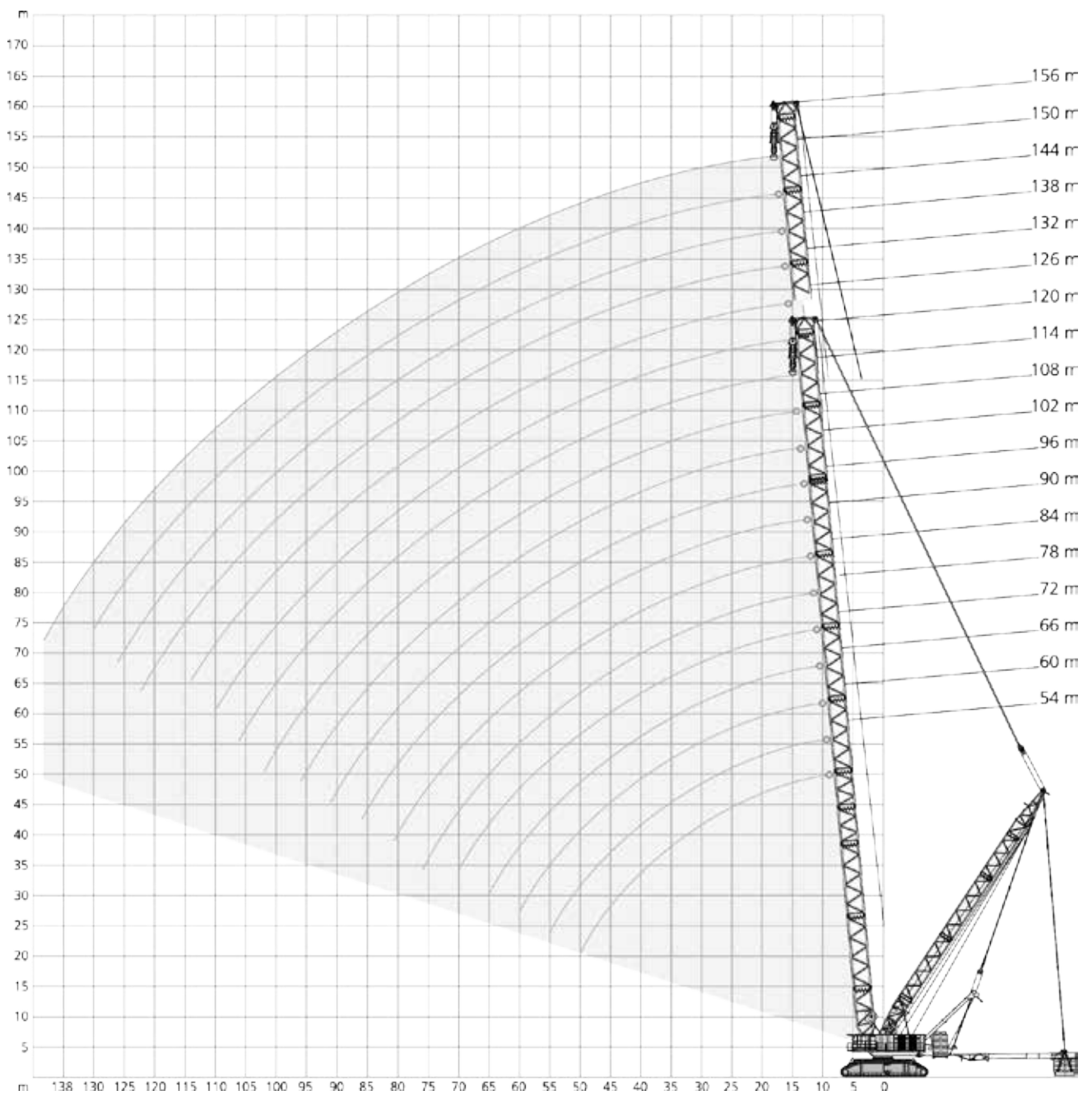

295 t + 60 t		19-30 m			10,5 m			9.8 m/s			360°		ISO
		54 m			60 m			66 m					
		0t	0-640t	800t	0t	0-640t	800t	0t	0-640t	800t			
m	t	t	t	t	t	t	t	t	t	t	m		
10	846,0	1600,0	1600,0	799,0	1555,0	1555,0	-	-	-	-	10		
11	766,5	1581,0	1581,0	726,5	1553,0	1553,0	684,0	1405,0	1405,0	1405,0	11		
12	687,0	1562,0	1562,0	654,0	1553,0	1553,0	623,0	1405,0	1405,0	1405,0	12		
14	576,0	1487,0	1487,0	551,0	1478,0	1478,0	527,0	1383,0	1383,0	1383,0	14		
16	494,0	1419,0	1419,0	474,0	1410,0	1410,0	455,0	1383,0	1383,0	1383,0	16		
18	431,0	1309,0	1356,0	414,0	1302,0	1347,0	398,0	1290,0	1330,0	1330,0	18		
20	379,0	1192,0	1304,0	367,0	1185,0	1295,0	353,0	1178,0	1274,0	1274,0	20		
22	327,0	1085,0	1248,0	323,0	1079,0	1241,0	315,0	1073,0	1219,0	1219,0	22		
24	286,0	992,0	1117,0	282,0	986,0	1135,0	278,0	980,0	1129,0	1129,0	24		
26	253,0	913,0	1003,0	249,0	907,0	1045,0	245,0	901,0	1039,0	1039,0	26		
28	226,0	845,0	906,0	222,0	839,0	953,0	218,0	833,0	961,0	961,0	28		
30	203,0	785,0	823,0	199,0	779,0	869,0	195,0	774,0	894,0	894,0	30		
34	168,0	687,0	699,0	163,0	682,0	730,0	159,0	676,0	760,0	760,0	34		
38	141,0	580,0	602,0	136,0	604,0	621,0	132,0	599,0	650,0	650,0	38		
42	121,0	491,0	512,0	116,0	532,0	551,0	111,0	536,0	562,0	562,0	42		
45	109,0	448,2	455,0	103,6	475,7	495,5	98,2	497,0	506,5	506,5	45		
46	105,0	436,0	436,0	99,5	457,0	477,0	94,0	484,0	493,0	493,0	46		
50	92,0	367,0	367,0	86,0	392,0	412,0	80,0	424,0	442,0	442,0	50		
54	-	-	-	75,0	353,0	353,0	68,5	369,0	387,0	387,0	54		
55	-	-	-	73,0	339,0	339,0	66,2	356,2	374,2	374,2	55		
58	-	-	-	-	-	-	59,5	324,0	336,0	336,0	58		
60	-	-	-	-	-	-	55,5	312,0	312,0	312,0	60		

		72 m			78 m			84 m			90 m				
		0t	0-640t	800t	0t	0-640t	800t	0t	0-640t	800t	0t	0-640t	800t		
m	t	t	t	t	t	t	t	t	t	t	t	t	t	m	
11	651,0	1238,0	1238,0	-	-	-	-	-	-	-	-	-	-	11	
12	594,0	1238,0	1238,0	568,0	1098,0	1098,0	543,0	976,0	976,0	976,0	-	-	-	12	
13	549,5	1238,0	1238,0	526,0	1098,0	1098,0	503,0	976,0	976,0	976,0	479,0	867,0	867,0	13	
14	505,0	1238,0	1238,0	484,0	1098,0	1098,0	463,0	976,0	976,0	976,0	445,0	867,0	867,0	14	
16	436,0	1238,0	1238,0	419,0	1098,0	1098,0	402,0	976,0	976,0	976,0	387,0	867,0	867,0	16	
18	383,0	1204,0	1231,0	368,0	1098,0	1098,0	353,0	976,0	976,0	976,0	340,0	867,0	867,0	18	
20	339,0	1168,0	1171,0	326,0	1060,0	1078,0	314,0	973,0	973,0	973,0	302,0	867,0	867,0	20	
22	303,0	1069,0	1133,0	292,0	1038,0	1049,0	281,0	940,0	954,0	954,0	270,0	858,0	858,0	22	
24	273,0	976,0	1097,0	263,0	973,0	1016,0	253,0	927,0	935,0	935,0	244,0	846,0	846,0	24	
26	242,0	897,0	1035,0	239,0	893,0	991,0	229,0	888,0	913,0	913,0	220,0	829,0	834,0	26	
28	215,0	829,0	957,0	213,0	825,0	950,0	208,0	820,0	893,0	893,0	200,0	818,0	822,0	28	
30	192,0	770,0	889,0	190,0	766,0	886,0	187,0	761,0	859,0	859,0	183,0	759,0	802,0	30	
34	156,0	672,0	778,0	154,0	668,0	774,0	150,0	663,0	769,0	769,0	149,0	661,0	748,0	34	
38	129,0	594,0	671,0	126,0	591,0	683,0	123,0	586,0	681,0	681,0	121,0	583,0	679,0	38	
42	108,0	532,0	583,0	104,0	528,0	597,0	100,0	523,0	603,0	603,0	98,5	521,0	606,0	42	
46	90,0	479,0	510,0	87,0	476,0	526,0	82,5	471,0	533,0	533,0	80,5	468,0	538,0	46	
50	76,0	435,0	448,0	72,0	431,0	465,0	68,0	426,0	474,0	474,0	65,5	423,0	481,0	50	
54	64,0	394,0	407,0	60,5	393,0	412,0	55,5	388,0	422,0	422,0	53,5	385,0	431,0	54	
58	54,5	346,0	362,0	50,5	361,0	371,0	45,8	355,0	377,0	377,0	43,2	353,0	387,0	58	
62	46,8	302,0	318,0	42,3	324,0	338,0	37,3	327,0	337,0	337,0	34,6	324,0	348,0	62	
65	41,9	278,0	287,0	37,1	294,7	309,5	31,9	307,5	318,2	318,2	29,0	306,0	321,7	65	
66	-	-	-	35,4	285,0	300,0	30,2	301,0	312,0	312,0	27,2	300,0	313,0	66	
70	-	-	-	29,8	249,0	264,0	24,2	267,0	281,0	281,0	20,9	278,0	287,0	70	
74	-	-	-	-	-	-	19,2	236,0	250,0	250,0	15,5	252,0	264,0	74	
76	-	-	-	-	-	-	17,0	220,0	234,0	234,0	13,2	238,0	250,0	76	
78	-	-	-	-	-	-	-	-	-	-	11,0	224,0	236,0	78	
79	-	-	-	-	-	-	-	-	-	-	10,0	217,0	229,3	79	
81	-	-	-	-	-	-	-	-	-	-	-	203,0	216,0	81	

	0t	340t	440t	540t	640t	800t
--	----	------	------	------	------	------

295 t + 60 t		19-30 m			10,5 m			9.8 m/s			360°		ISO	
		96 m			102 m			108 m						
		0 t	0-640 t	800 t	0 t	0-640 t	800 t	0 t	0-640 t	800 t				
m	t	t	t	t	t	t	t	t	t	t				
13	459,0	775,0	775,0	-	-	-	-	-	-	-				
14	426,0	775,0	775,0	409,0	695,0	695,0	392,0	625,0	625,0	625,0				
16	371,0	775,0	775,0	357,0	695,0	695,0	342,0	625,0	625,0	625,0				
18	327,0	775,0	775,0	314,0	695,0	695,0	302,0	625,0	625,0	625,0				
20	290,0	775,0	775,0	279,0	695,0	695,0	268,0	625,0	625,0	625,0				
22	260,0	774,0	774,0	250,0	695,0	695,0	240,0	625,0	625,0	625,0				
24	234,0	766,0	766,0	225,0	692,0	692,0	215,0	624,0	624,0	624,0				
26	212,0	759,0	759,0	203,0	687,0	687,0	194,0	621,0	621,0	621,0				
28	192,0	747,0	751,0	184,0	683,0	683,0	176,0	617,0	617,0	617,0				
30	175,0	743,0	743,0	168,0	674,0	678,0	160,0	613,0	613,0	613,0				
34	146,0	657,0	701,0	140,0	653,0	661,0	133,0	600,0	605,0	605,0				
38	118,0	579,0	656,0	115,0	576,0	616,0	111,0	569,0	577,0	577,0				
42	95,0	516,0	603,0	92,0	513,0	579,0	90,0	510,0	539,0	539,0				
46	77,0	464,0	537,0	73,5	461,0	534,0	71,5	458,0	508,0	508,0				
50	62,0	419,0	481,0	58,5	416,0	480,0	56,5	413,0	477,0	477,0				
54	49,7	381,0	433,0	46,5	378,0	433,0	44,3	375,0	432,0	432,0				
58	39,4	348,0	390,0	36,1	345,0	392,0	33,8	342,0	392,0	392,0				
62	30,6	320,0	353,0	27,2	316,0	355,0	24,8	314,0	357,0	357,0				
66	23,1	295,0	319,0	19,6	292,0	323,0	17,0	289,0	325,0	325,0				
70	16,6	274,0	288,0	13,0	270,0	293,0	10,3	267,0	297,0	297,0				
72	13,8	264,0	274,0	10,1	260,0	279,5	-	257,0	283,5	283,5				
74	11,1	254,0	262,0	-	250,0	266,0	-	247,0	270,0	270,0				
78	-	234,0	245,0	-	233,0	241,0	-	230,0	247,0	247,0				
82	-	209,0	221,0	-	218,0	225,0	-	214,0	224,0	224,0				
86	-	185,0	197,0	-	196,0	206,0	-	200,0	207,0	207,0				
90	-	-	-	-	175,0	186,0	-	183,0	192,0	192,0				
91	-	-	-	-	169,0	180,0	-	178,2	187,5	187,5				
94	-	-	-	-	-	-	-	164,0	174,0	174,0				
96	-	-	-	-	-	-	-	154,0	165,0	165,0				

		114 m			120 m						
		0 t	0-640 t	800 t	0 t	0-640 t	800 t				
m	t	t	t	t	t	t					
15	351,0	550,0	552,0	336,0	495,0	496,0					
16	329,0	550,0	552,0	315,0	495,0	496,0					
18	290,0	550,0	552,0	278,0	495,0	496,0					
20	258,0	550,0	552,0	247,0	495,0	496,0					
22	230,0	550,0	552,0	220,0	495,0	496,0					
24	207,0	550,0	552,0	197,0	495,0	496,0					
26	186,0	550,0	552,0	178,0	495,0	496,0					
28	168,0	550,0	552,0	160,0	494,0	495,0					
30	153,0	550,0	552,0	145,0	493,0	495,0					
34	126,0	548,0	549,0	119,0	492,0	493,0					
38	105,0	516,0	529,0	98,5	480,0	481,0					
42	86,0	487,0	503,0	81,0	453,0	465,0					
46	67,5	452,0	484,0	64,5	430,0	444,0					
50	52,5	409,0	466,0	49,7	401,0	430,0					
54	40,3	371,0	426,0	37,1	367,0	415,0					
58	29,7	338,0	387,0	26,4	334,0	383,0					
60	25,1	323,5	370,0	21,7	319,0	366,0					
62	20,6	309,0	353,0	-	306,0	349,0					
66	-	284,0	323,0	-	281,0	320,0					
70	-	262,0	295,0	-	259,0	293,0					
74	-	243,0	270,0	-	239,0	269,0					
78	-	225,0	247,0	-	221,0	247,0					
82	-	210,0	226,0	-	206,0	226,0					
86	-	196,0	206,0	-	192,0	207,0					
90	-	183,0	190,0	-	179,0	189,0					
94	-	169,0	177,0	-	167,0	173,0					
98	-	152,0	161,0	-	156,0	163,0					
102	-	135,0	145,0	-	140,0	149,0					
106	-	-	-	-	125,0	134,0					
107	-	-	-	-	121,0	130,0					

 0 t 340 t 440 t 540 t 640 t 800 t

295 t + 60 t		19-30 m			10,5 m			9.8 m/s			360°			ISO
114 m		120 m			126 m			132 m						
	0t	0-640t	800t	0t	0-640t	800t	0t	0-640t	800t	0t	0-640t	800t		
m	t	t	t	t	t	t	t	t	t	t	t	t	m	
16	333,0	562,0	566,0	321,0	506,0	508,0	311,0	457,0	458,0	300,0	410,0	411,0	16	
18	295,0	562,0	566,0	284,0	506,0	508,0	276,0	457,0	458,0	266,0	410,0	411,0	18	
20	263,0	562,0	566,0	252,0	506,0	508,0	246,0	457,0	458,0	237,0	410,0	411,0	20	
22	235,0	562,0	566,0	226,0	506,0	508,0	220,0	456,0	457,0	212,0	410,0	411,0	22	
24	212,0	562,0	566,0	203,0	506,0	508,0	198,0	456,0	457,0	191,0	410,0	411,0	24	
26	191,0	561,0	566,0	184,0	506,0	508,0	179,0	456,0	457,0	173,0	410,0	411,0	26	
28	174,0	559,0	562,0	166,0	504,0	506,0	162,0	453,0	453,0	156,0	410,0	409,0	28	
30	158,0	556,0	554,0	151,0	501,0	500,0	147,0	447,0	446,0	142,0	410,0	407,0	30	
34	131,0	552,0	539,0	125,0	495,0	490,0	122,0	435,0	431,0	117,0	409,0	403,0	34	
38	110,0	529,0	524,0	104,0	489,0	480,0	102,0	423,0	417,0	97,5	408,0	398,0	38	
42	91,0	504,0	509,0	87,0	458,0	469,0	85,0	405,0	403,0	80,5	403,0	394,0	42	
46	72,5	459,0	486,0	70,5	438,0	456,0	70,5	388,0	391,0	66,5	388,0	390,0	46	
50	57,5	415,0	460,0	55,0	412,0	430,0	56,0	370,0	375,0	54,5	365,0	383,0	50	
54	45,2	376,0	432,0	42,8	374,0	409,0	43,5	352,0	357,0	42,4	352,0	368,0	54	
58	34,6	343,0	393,0	32,1	341,0	387,0	32,8	334,0	338,0	31,7	339,0	349,0	58	
62	25,6	315,0	359,0	23,0	312,0	357,0	23,7	312,0	320,0	22,5	311,0	334,0	62	
66	17,8	290,0	329,0	15,2	287,0	328,0	15,8	287,0	302,0	14,6	286,0	319,0	66	
70	11,1	268,0	301,0	-	265,0	301,0	-	265,0	284,0	-	264,0	300,0	70	
74	-	248,0	276,0	-	245,0	277,0	-	245,0	269,0	-	244,0	277,0	74	
78	-	231,0	253,0	-	228,0	255,0	-	228,0	254,0	-	226,0	256,0	78	
82	-	215,0	232,0	-	212,0	234,0	-	212,0	237,0	-	210,0	237,0	82	
86	-	201,0	212,0	-	198,0	215,0	-	198,0	219,0	-	196,0	219,0	86	
90	-	188,0	195,0	-	185,0	197,0	-	185,0	202,0	-	183,0	202,0	90	
94	-	175,0	183,0	-	173,0	180,0	-	173,0	186,0	-	171,0	187,0	94	
98	-	158,0	167,0	-	163,0	170,0	-	162,0	170,0	-	160,0	172,0	98	
102	-	141,0	151,0	-	147,0	156,0	-	153,0	159,0	-	151,0	158,0	102	
106	-	-	-	-	132,0	142,0	-	140,0	149,0	-	141,0	147,0	106	
110	-	-	-	-	-	-	-	126,0	135,0	-	131,0	138,0	110	
114	-	-	-	-	-	-	-	-	-	-	119,0	126,0	114	

138 m		144 m			150 m			156 m						
	0t	0-640t	800t	0t	0-640t	800t	0t	0-640t	800t	0t	0-640t	800t		
m	t	t	t	t	t	t	t	t	t	t	t	t	m	
18	258,0	369,0	371,0	248,0	331,0	332,0	243,0	299,0	299,0	234,0	268,0	268,0	18	
20	230,0	369,0	371,0	221,0	331,0	332,0	217,0	299,0	299,0	209,0	268,0	268,0	20	
22	206,0	369,0	371,0	198,0	331,0	332,0	195,0	299,0	299,0	187,0	268,0	268,0	22	
24	185,0	369,0	371,0	179,0	331,0	332,0	175,0	299,0	299,0	169,0	268,0	268,0	24	
26	167,0	369,0	371,0	161,0	331,0	332,0	158,0	299,0	299,0	152,0	267,0	268,0	26	
28	151,0	369,0	371,0	145,0	331,0	332,0	143,0	299,0	299,0	137,0	267,0	268,0	28	
30	137,0	369,0	371,0	132,0	331,0	332,0	130,0	299,0	299,0	124,0	267,0	268,0	30	
34	113,0	368,0	367,0	108,0	331,0	329,0	107,0	298,0	298,0	102,0	265,0	266,0	34	
38	94,0	367,0	361,0	89,0	330,0	324,0	88,5	296,0	295,0	83,5	262,0	263,0	38	
42	77,5	366,0	356,0	73,0	329,0	320,0	72,5	294,0	292,0	68,0	259,0	260,0	42	
46	63,5	355,0	351,0	59,5	323,0	316,0	59,0	291,0	289,0	55,0	256,0	257,0	46	
50	52,0	344,0	345,0	48,0	313,0	312,0	47,9	283,0	287,0	44,0	251,0	254,0	50	
54	40,8	323,0	340,0	37,8	304,0	308,0	38,0	276,0	284,0	34,1	246,0	251,0	54	
58	30,0	313,0	334,0	29,0	290,0	303,0	29,2	269,0	280,0	25,4	240,0	248,0	58	
62	20,8	303,0	318,0	19,7	279,0	292,0	20,5	262,0	272,0	17,8	235,0	245,0	62	
66	12,8	284,0	304,0	11,7	270,0	281,0	12,5	250,0	263,0	11,0	229,0	238,0	66	
70	-	262,0	291,0	-	260,0	269,0	-	244,0	255,0	-	221,0	231,0	70	
74	-	242,0	274,0	-	240,0	257,0	-	237,0	246,0	-	215,0	224,0	74	
78	-	224,0	254,0	-	223,0	247,0	-	223,0	235,0	-	210,0	217,0	78	
82	-	208,0	235,0	-	207,0	234,0	-	207,0	227,0	-	205,0	210,0	82	
86	-	194,0	218,0	-	193,0	217,0	-	193,0	217,0	-	192,0	201,0	86	
90	-	181,0	202,0	-	179,0	201,0	-	180,0	202,0	-	179,0	195,0	90	
94	-	169,0	187,0	-	168,0	187,0	-	168,0	188,0	-	167,0	185,0	94	
98	-	158,0	173,0	-	157,0	173,0	-	157,0	174,0	-	156,0	172,0	98	
102	-	148,0	159,0	-	147,0	160,0	-	147,0	162,0	-	146,0	160,0	102	
106	-	139,0	147,0	-	137,0	148,0	-	138,0	150,0	-	136,0	149,0	106	
110	-	131,0	136,0	-	129,0	136,0	-	129,0	139,0	-	128,0	138,0	110	
114	-	122,0	128,0	-	121,0	126,0	-	122,0	128,0	-	120,0	128,0	114	
118	-	111,0	117,0	-	114,0	119,0	-	114,0	119,0	-	112,0	118,0	118	
122	-	99,5	107,0	-	103,0	109,0	-	108,0	112,0	-	106,0	110,0	122	
126	-	-	-	-	93,0	99,5	-	98,0	103,0	-	99,5	103,0	126	
130	-	-	-	-	-	-	-	88,5	94,5	-	90,5	95,0	130	
134	-	-	-	-	-	-	-	-	-	-	81,5	87,0	134	
138	-	-	-	-	-	-	-	-	-	-	72,5	78,5	138	

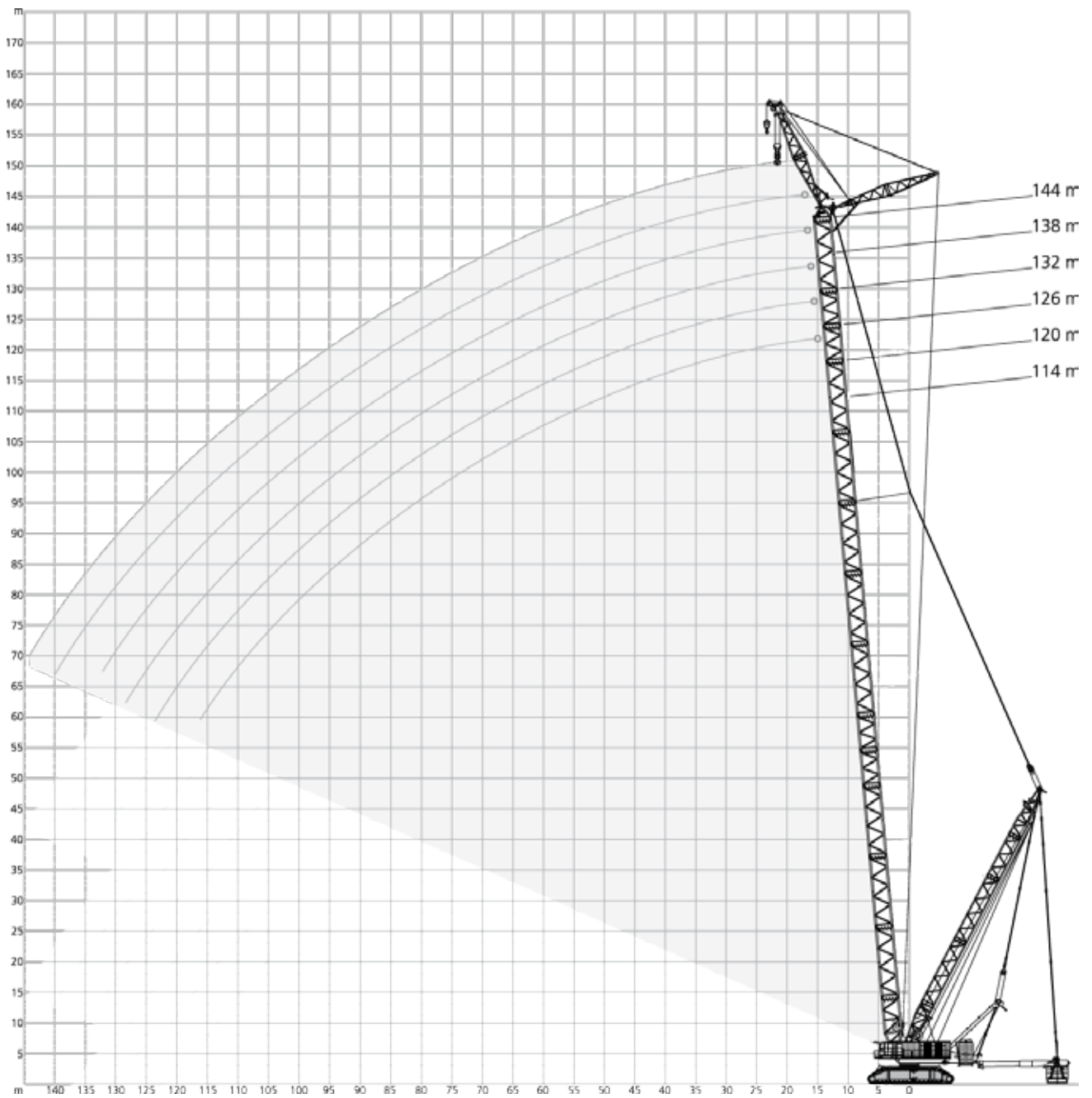

295 t + 60 t		19-30 m		10,5 m		9.8 m/s		360°		ISO		
114 m		120 m		126 m		132 m		138 m		144 m		
0t 0-640t		0t 0-640t		0t 0-640t		0t 0-640t		0t 0-640t		0t 0-640t		
m	t	t	t	t	t	t	t	t	t	t	t	m
22	-	366,0	-	330,0	-	303,0	-	-	-	-	-	22
24	208,0	366,0	200,0	330,0	192,0	303,0	-	273,0	-	246,0	-	24
26	188,0	366,0	181,0	330,0	173,0	302,0	165,0	273,0	160,0	245,0	153,0	26
28	171,0	366,0	164,0	330,0	156,0	302,0	149,0	273,0	144,0	245,0	138,0	28
30	156,5	365,5	150,0	329,5	142,5	302,0	135,5	273,0	131,0	245,0	125,0	30
34	130,0	363,5	124,5	328,0	117,5	301,5	111,0	273,0	107,0	244,5	101,2	34
38	108,5	360,5	103,5	326,0	96,7	300,0	90,7	272,0	87,0	242,5	81,7	38
42	90,7	357,5	86,0	323,5	79,5	297,5	73,7	269,5	70,5	239,5	65,5	42
46	75,7	352,0	71,0	319,5	64,7	294,5	59,2	267,0	56,5	236,5	51,6	46
50	63,0	343,5	58,2	313,5	52,4	290,5	46,9	263,5	44,3	233,0	39,6	50
54	51,8	332,5	47,4	306,5	41,7	285,0	36,4	258,5	33,6	229,0	29,1	54
56	46,7	328,0	42,4	303,0	36,6	282,0	31,4	256,0	28,7	227,0	24,3	56
58	41,4	323,5	37,7	299,5	32,1	279,5	26,9	253,5	-	224,5	-	58
60	36,1	319,0	33,0	296,0	27,7	277,0	22,5	251,0	-	222,0	-	60
62	31,4	311,0	28,3	292,5	-	273,0	-	248,5	-	220,0	-	62
64	26,8	303,0	23,6	289,0	-	270,0	-	246,0	-	218,0	-	64
66	-	292,0	-	280,5	-	265,5	-	241,0	-	215,5	-	66
70	-	270,0	-	263,0	-	255,0	-	232,0	-	210,0	-	70
74	-	249,5	-	245,0	-	240,5	-	217,0	-	198,5	-	74
78	-	231,5	-	227,0	-	223,5	-	201,5	-	182,5	-	78
82	-	215,5	-	211,0	-	207,0	-	186,0	-	167,5	-	82
86	-	201,0	-	197,0	-	192,0	-	171,0	-	151,5	-	86
90	-	187,5	-	183,5	-	178,5	-	159,5	-	137,0	-	90
94	-	175,0	-	171,5	-	166,5	-	150,0	-	127,0	-	94
98	-	164,0	-	160,5	-	155,5	-	140,5	-	118,5	-	98
102	-	153,5	-	150,0	-	145,0	-	131,5	-	110,0	-	102
106	-	141,0	-	140,5	-	135,5	-	122,5	-	102,0	-	106
110	-	127,5	-	129,5	-	126,5	-	113,0	-	93,7	-	110
114	-	114,5	-	117,0	-	116,0	-	106,5	-	85,2	-	114
116	-	108,0	-	111,0	-	110,0	-	105,0	-	81,0	-	116
118	-	-	-	105,0	-	104,7	-	101,7	-	79,5	-	118
122	-	-	-	93,0	-	94,0	-	93,2	-	76,5	-	122
124	-	-	-	87,0	-	88,5	-	88,0	-	75,0	-	124
126	-	-	-	-	-	83,0	-	83,0	-	73,2	-	126
128	-	-	-	-	-	77,5	-	78,0	-	71,5	-	128
130	-	-	-	-	-	-	-	73,0	-	70,0	-	130
132	-	-	-	-	-	-	-	68,0	-	68,5	-	132
134	-	-	-	-	-	-	-	-	-	65,0	-	134
138	-	-	-	-	-	-	-	-	-	57,0	-	138
140	-	-	-	-	-	-	-	-	-	52,5	-	140
142	-	-	-	-	-	-	-	-	-	-	-	142
144	-	-	-	-	-	-	-	-	-	-	-	144

0 t
340 t
440 t
540 t
640 t

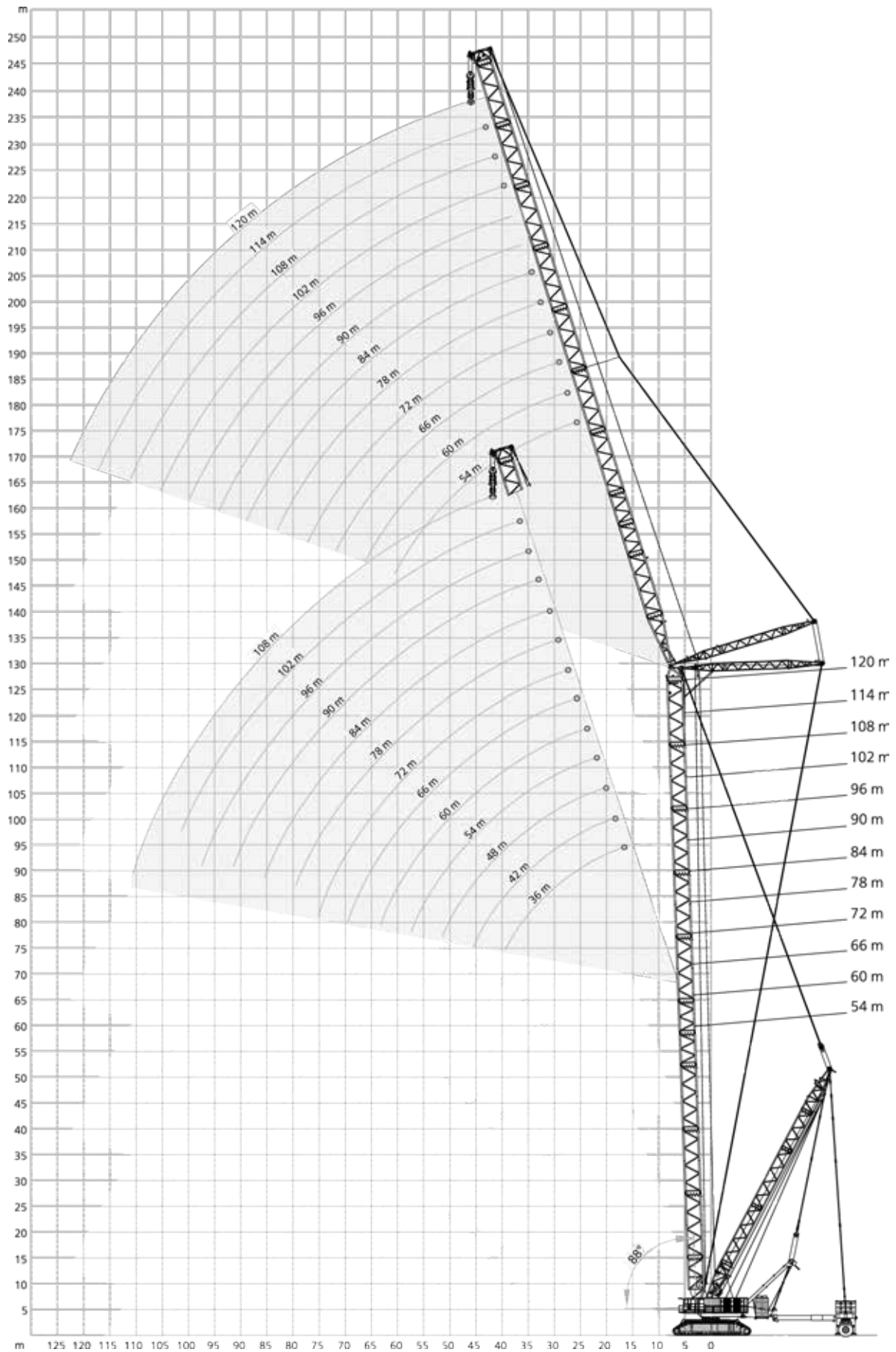

295 t + 60 t 19-30 m 10,5 m 9.8 m/s 360° ISO								
54 m + 36 m								
SWSL								SFSL
0 t 0 t-640 t								
88°/85° 88°/85° 75° 65° 55° 45°								
m	t	t	t	t	t	t	t	t
18	403,0*	629,0*	-	-	-	-	-	-
20	364,0*	614,0*	-	-	-	-	-	-
22	331,0*	594,0*	-	-	-	-	-	-
24	304,0*	653,0	-	-	-	-	-	640,0
26	280,0*	639,0	-	-	-	-	-	640,0
28	260,0*	603,0	-	-	-	-	-	640,0
30	242,0*	543,0	-	-	-	-	-	640,0
34	205,0*	450,0	-	-	-	-	-	632,0
37	182,5*	398,5	613,0	-	-	-	-	611,5
38	176,0*	383,0	582,0	-	-	-	-	598,0
42	146,0	332,0	478,0	-	-	-	-	532,0
46	-	-	403,0	-	-	-	-	477,0
50	-	-	348,0	-	-	-	-	431,0
51	-	-	336,5	424,0	-	-	-	420,5
52	-	-	325,0	414,0	-	-	-	410,0
54	-	-	-	397,0	-	-	-	389,0
58	-	-	-	360,0	-	-	-	345,0
61	-	-	-	325,0	-	-	-	315,7
62	-	-	-	-	-	-	-	306,0
64	-	-	-	-	291,0	-	-	288,5
66	-	-	-	-	280,0	-	-	271,0
69	-	-	-	-	265,0	-	-	247,7
70	-	-	-	-	-	-	-	240,0
74	-	-	-	-	-	222,0	-	220,0
76	-	-	-	-	-	215,0	-	208,0
78	-	-	-	-	-	-	-	196,0
82	-	-	-	-	-	-	-	170,0

54 m + 48 m								
m	t	t	t	t	t	t	t	t
22	311,0*	496,0*	-	-	-	-	-	-
24	286,0*	484,0*	-	-	-	-	-	-
26	264,0*	471,0*	-	-	-	-	-	-
28	244,0*	516,0	-	-	-	-	-	504,0
30	227,0*	508,0	-	-	-	-	-	504,0
34	199,0*	484,0	-	-	-	-	-	504,0
38	173,0*	411,0	-	-	-	-	-	504,0
42	150,0*	356,0	-	-	-	-	-	496,0
43	145,0*	344,5	490,0	-	-	-	-	488,0
46	131,0*	313,0	434,0	-	-	-	-	463,0
50	116,0*	278,0	373,0	-	-	-	-	431,0
54	99,0	244,0	326,0	-	-	-	-	393,0
58	-	-	289,0	-	-	-	-	358,0
59	-	-	281,0	354,0	-	-	-	349,5
62	-	-	259,0	333,0	-	-	-	324,0
66	-	-	-	297,0	-	-	-	291,0
70	-	-	-	265,0	-	-	-	260,0
72	-	-	-	252,0	-	-	-	246,5
73	-	-	-	-	241,0	-	-	239,7
74	-	-	-	-	237,0	-	-	233,0
78	-	-	-	-	222,0	-	-	208,0
80	-	-	-	-	215,0	-	-	197,5
82	-	-	-	-	-	-	-	190,0
85	-	-	-	-	-	181,0	-	177,2
86	-	-	-	-	-	178,0	-	173,0
87	-	-	-	-	-	176,0	-	167,7
90	-	-	-	-	-	-	-	152,0
94	-	-	-	-	-	-	-	132,0

54 m + 60 m								
SWSL								SFSL
0 t 0 t-640 t								
88°/85° 88°/85° 75° 65° 55° 45°								
m	t	t	t	t	t	t	t	t
26	249,0*	394,0*	-	-	-	-	-	-
28	231,0*	386,0*	-	-	-	-	-	-
30	215,0*	378,0*	-	-	-	-	-	-
32	201,0*	411,0	-	-	-	-	-	401,0
34	188,0*	406,0	-	-	-	-	-	401,0
38	166,0*	396,0	-	-	-	-	-	401,0
42	149,0*	367,0	-	-	-	-	-	401,0
46	131,0*	322,0	-	-	-	-	-	401,0
49	119,5*	293,5	400,0	-	-	-	-	391,0
50	116,0*	285,0	385,0	-	-	-	-	387,0
54	103,0*	255,0	336,0	-	-	-	-	363,0
58	92,5*	229,0	297,0	-	-	-	-	340,0
62	83,5*	208,0	264,0	-	-	-	-	319,0
64	75,0	197,0	250,0	-	-	-	-	310,0
66	-	-	238,0	-	-	-	-	301,0
67	-	-	-	232,0	-	-	-	295,2
70	-	-	-	215,0	-	-	-	278,0
74	-	-	-	195,0	243,0	-	-	251,0
78	-	-	-	-	220,0	-	-	227,0
82	-	-	-	-	200,0	205,0	-	204,0
86	-	-	-	-	-	193,0	-	184,0
90	-	-	-	-	-	182,0	-	167,0
92	-	-	-	-	-	176,0	-	161,0
94	-	-	-	-	-	-	-	155,0
95	-	-	-	-	-	-	153,0	150,7
98	-	-	-	-	-	-	146,0	138,0
99	-	-	-	-	-	-	144,0	134,0
102	-	-	-	-	-	-	-	122,0
106	-	-	-	-	-	-	-	105,0

54 m + 72 m								
m	t	t	t	t	t	t	t	t
30	203,0*	315,0*	-	-	-	-	-	-
34	177,0*	306,0*	-	-	-	-	-	-
36	167,0*	328,0	-	-	-	-	-	321,0
38	157,0*	325,0	-	-	-	-	-	321,0
42	140,0*	320,0	-	-	-	-	-	321,0
46	125,0*	314,0	-	-	-	-	-	321,0
50	113,0*	283,0	-	-	-	-	-	321,0
54	100,0*	253,0	-	-	-	-	-	315,0
56	95,0*	240,0	314,0	-	-	-	-	309,5
58	89,5*	227,0	295,0	-	-	-	-	304,0
62	80,5*	206,0	263,0	-	-	-	-	286,0
66	72,5*	187,0	236,0	-	-	-	-	269,0
70	65,5*	171,0	213,0	-	-	-	-	253,0
74	59,5*	157,0	193,0	241,0	-	-	-	239,0
76	52,0	146,0	185,0	229,0	-	-	-	233,0
78	-	-	176,0	218,0	-	-	-	227,0
82	-	-	162,0	198,0	-	-	-	215,0
86	-	-	149,0	180,0	-	-	-	196,0
90	-	-	-	165,0	-	-	-	178,0
91	-	-	-	161,5	174,0	-	-	173,5
94	-	-	-	152,0	166,0	-	-	160,0
98	-	-	-	-	157,0	-	-	145,0
102	-	-	-	-	148,0	-	-	136,0
105	-	-	-	-	-	-	127,0	126,2
106	-	-	-	-	-	-	125,0	123,0
110	-	-	-	-	-	-	118,0	109,0
114	-	-	-	-	-	-	-	95,5

0t 100t 180t 240t 340t 440t 540t 640t

For explanations see page 22 · Bemerkungen siehe Seite 22 · Pour plus de détails, voir page 22 · Per spiegazioni vedere a pagina 22 · Véase p. 22 para más información · Para explicações, ver página 22 · Объяснения см. на стр. 22

295 t + 60 t									19-30 m									10,5 m									9.8 m/s									360°									ISO								
54 m + 84 m									SWSL									SFSL									54 m + 96 m									SWSL									SFSL								
0 t			0 t - 640 t						0 t			0 t - 640 t						0 t			0 t - 640 t						0 t			0 t - 640 t						0 t			0 t - 640 t														
88°/85°			88°/85°			75°			65°			55°			45°			88°/85°			88°/85°			75°			65°			55°			45°			88°/85°			88°/85°			75°			65°			55°			45°		
m	t	t	t	t	t	t	t	t	m	t	t	t	t	t	t	t	m	t	t	t	t	t	t	t	m	t	t	t	t	t	t	t	m	t	t	t	t	t	t	t													
32	176,0*	254,0*	-	-	-	-	-	-	36	145,0*	201,0*	-	-	-	-	-	36	145,0*	201,0*	-	-	-	-	-	-	-	36	145,0*	201,0*	-	-	-	-	-	-	-	-																
34	165,0*	253,0*	-	-	-	-	-	-	38	136,0*	200,0*	-	-	-	-	-	38	136,0*	200,0*	-	-	-	-	-	-	-	38	136,0*	200,0*	-	-	-	-	-	-	-	-																
38	145,0*	247,0*	-	-	-	-	-	-	42	120,0*	197,0*	-	-	-	-	-	42	120,0*	197,0*	-	-	-	-	-	-	-	42	120,0*	197,0*	-	-	-	-	-	-	-	-																
40	137,0*	261,0	-	-	-	-	-	-	44	113,0*	203,0	-	-	-	-	-	44	113,0*	203,0	-	-	-	-	-	-	-	44	113,0*	203,0	-	-	-	-	-	-	203,0	-																
42	129,0*	260,0	-	-	-	-	-	-	46	107,0*	203,0	-	-	-	-	-	46	107,0*	203,0	-	-	-	-	-	-	-	46	107,0*	203,0	-	-	-	-	-	-	203,0	-																
46	115,0*	256,0	-	-	-	-	-	-	50	95,5*	200,0	-	-	-	-	-	50	95,5*	200,0	-	-	-	-	-	-	-	50	95,5*	200,0	-	-	-	-	-	-	203,0	-																
50	103,0*	252,0	-	-	-	-	-	-	54	85,5*	198,0	-	-	-	-	-	54	85,5*	198,0	-	-	-	-	-	-	-	54	85,5*	198,0	-	-	-	-	-	-	201,0	-																
54	93,0*	247,0	-	-	-	-	-	-	58	76,5*	196,0	-	-	-	-	-	58	76,5*	196,0	-	-	-	-	-	-	-	58	76,5*	196,0	-	-	-	-	-	-	200,0	-																
58	84,0*	221,0	-	-	-	-	-	-	62	69,0*	193,0	-	-	-	-	-	62	69,0*	193,0	-	-	-	-	-	-	-	62	69,0*	193,0	-	-	-	-	-	-	199,0	-																
62	75,0*	199,0	254,0	-	-	-	-	-	66	62,0*	179,0	-	-	-	-	-	66	62,0*	179,0	-	-	-	-	-	-	-	66	62,0*	179,0	-	-	-	-	-	-	195,0	-																
66	67,0*	181,0	229,0	-	-	-	-	-	68	59,0*	171,0	193,0	-	-	-	-	68	59,0*	171,0	193,0	-	-	-	-	-	-	68	59,0*	171,0	193,0	-	-	-	-	-	193,5	-																
70	59,5*	165,0	207,0	-	-	-	-	-	70	56,0*	163,0	193,0	-	-	-	-	70	56,0*	163,0	193,0	-	-	-	-	-	-	70	56,0*	163,0	193,0	-	-	-	-	-	192,0	-																
74	53,0*	151,0	187,0	-	-	-	-	-	74	49,9*	148,0	185,0	-	-	-	-	74	49,9*	148,0	185,0	-	-	-	-	-	-	74	49,9*	148,0	185,0	-	-	-	-	-	188,0	-																
78	47,4*	138,0	170,0	-	-	-	-	-	78	44,0*	136,0	168,0	-	-	-	-	78	44,0*	136,0	168,0	-	-	-	-	-	-	78	44,0*	136,0	168,0	-	-	-	-	-	184,0	-																
82	42,4*	127,0	155,0	191,0	-	-	-	-	82	38,8*	124,5	153,0	-	-	-	-	82	38,8*	124,5	153,0	-	-	-	-	-	-	82	38,8*	124,5	153,0	-	-	-	-	-	173,0	-																
84	40,1*	122,0	149,0	182,0	-	-	-	-	86	34,2*	114,5	140,0	-	-	-	-	86	34,2*	114,5	140,0	-	-	-	-	-	-	86	34,2*	114,5	140,0	-	-	-	-	-	164,0	-																
86	33,6	115,5	142,0	174,0	-	-	-	-	90	30,1*	105,5	128,0	156,0	-	-	-	90	30,1*	105,5	128,0	156,0	-	-	-	-	-	90	30,1*	105,5	128,0	156,0	-	-	-	-	155,0	-																
88	31,7	109,0	136,0	166,0	-	-	-	-	94	26,5*	97,5	118,0	143,0	-	-	-	94	26,5*	97,5	118,0	143,0	-	-	-	-	-	94	26,5*	97,5	118,0	143,0	-	-	-	-	147,0	-																
90	-	-	131,0	159,0	-	-	-	-	96	24,8*	94,0	113,0	137,0	-	-	-	96	24,8*	94,0	113,0	137,0	-	-	-	-	-	96	24,8*	94,0	113,0	137,0	-	-	-	-	143,0	-																
94	-	-	121,0	145,0	-	-	-	-	98	-	-	109,0	131,0	-	-	-	98	-	-	109,0	131,0	-	-	-	-	-	98	-	-	109,0	131,0	-	-	-	-	139,0	-																
96	-	-	116,0	139,0	-	-	-	-	102	-	-	100,0	120,0	-	-	-	102	-	-	100,0	120,0	-	-	-	-	-	102	-	-	100,0	120,0	-	-	-	-	133,0	-																
98	-	-	-	134,0	-	-	-	-	106	-	-	93,0	111,0	-	-	-	106	-	-	93,0	111,0	-	-	-	-	-	106	-	-	93,0	111,0	-	-	-	-	126,0	-																
100	-	-	-	128,0	143,0	-	-	-	108	-	-	89,5	106,0	-	-	-	108	-	-	89,5	106,0	-	-	-	-	-	108	-	-	89,5	106,0	-	-	-	-	122,0	-																
102	-	-	-	123,0	139,0	-	-	-	110	-	-	-	102,0	119,0	-	-	110	-	-	-	102,0	119,0	-	-	-	-	110	-	-	-	102,0	119,0	-	-	-	-	118,0	-															
106	-	-	-	114,0	131,0	-	-	-	114	-	-	-	94,5	111,0	-	-	114	-	-	-	94,5	111,0	-	-	-	-	114	-	-	-	94,5	111,0	-	-	-	-	107,0	-															
110	-	-	-	-	124,0	-	-	-	118	-	-	-	87,5	103,0	-	-	118	-	-	-	87,5	103,0	-	-	-	-	118	-	-	-	87,5	103,0	-	-	-	-	100,0	-															
114	-	-	-	-	114,0	-	-	-	122	-	-	-	-	95,5	-	-	122	-	-	-	-	95,5	-	-	-	-	122	-	-	-	-	95,5	-	-	-	-	91,5	-															
116	-	-	-	-	-	100,0	-	-	126	-	-	-	-	88,0	81,5	-	126	-	-	-	-	88,0	81,5	-	-	-	126	-	-	-	-	88,0	81,5	-	-	-	81,0	-															
118	-	-	-	-	-	97,5	93,0	-	130	-	-	-	-	-	77,0	71,0	130	-	-	-	-	-	-	-	-	130	-	-	-	-	-	-	-	77,0	71,0	-	-	71,0	-														
122	-	-	-	-	-	92,5	81,5	-	132	-	-	-	-	-	75,0	66,2	132	-	-	-	-	-	-	-	-	132	-	-	-	-	-	-	-	75,0	66,2	-	-	66,2	-														
126	-	-	-	-	-	-	70,0	-	134	-	-	-	-	-	-	61,5	134	-	-	-	-	-	-	-	-	134	-	-	-	-	-	-	-	-	-	61,5	-																
									138	-	-	-	-	-	-	51,5	138	-	-	-	-	-	-	-	-	138	-	-	-	-	-	-	-	-	-	51,5	-																

	0 t	100 t	180 t	240 t	340 t	440 t	540 t	640 t
--	-----	-------	-------	-------	-------	-------	-------	-------

6 m steps of luffing jib is standard · 6 m Stufung der Wippe ist Standard · Des paliers de 6 m sont de série pour la fléchette · Falcone standard con sezioni di 6 m · Incrementos de 6 m para plumín abatible son estándar · Lances de 6 m da lança auxiliar como padrão · 6 м шаг размера гуська является стандартом

* Main boom angle 88° · Hauptauslegerwinkel 88° · Jarret de flèche principale 88° · Inclinazione braccio base 88° · Ángulo de pluma principal 88° · Ángulo da lança principal 88° · Угол подъема гл. стрелы 88°

Main boom angle 88°, 85°, 75°, 65°, 55° and 45°; capacities for intermediate boom positions are calculated by the crane control system IC-1 Hauptauslegerwinkel 88°, 85°, 75°, 65°, 55° und 45°; Traglasten für Zwischenstellungen des Hauptauslegers werden von der Kransteuerung IC-1 berechnet

Jarret de flèche principale 88°, 85°, 75°, 65°, 55° et 45°; le système de commande de la grue IC-1 calcule les charges pour les positions intermédiaires de la flèche

Inclinazione braccio base 88°, 85°, 75°, 65°, 55° e 45°, capacità per posizioni intermedie del braccio sono calcolate dal sistema di controllo della gru IC-1

Ángulo de pluma principal 88°, 85°, 75°, 65°, 55° y 45° las capacidades para posiciones de pluma intermedias son calculadas por el sistema de control de grúa IC-1

Ángulos da lança principal 88°, 85°, 75°, 65°, 55° e 45°; as capacidades para posições da lança intermediária são calculadas pelo sistema de controle da grua IC-1

Грузоподъемность при углах подъема главной стрелы 88°, 85°, 75°, 65°, 55° и 45°, грузоподъемность в промежуточных положениях стрелы рассчитывается системой управления краном IC-1

295 t + 60 t		19-30 m		10,5 m		9.8 m/s		360°		ISO	
54 m + 108 m		SWSL		SFSL		60 m + 36 m		SWSL		SFSL	
0 t		0 t - 640 t		0 t		0 t - 640 t		0 t		0 t - 640 t	
88°/85°		88°/85°		75°		65°		55°		45°	
m	t	t	t	t	t	t	t	t	t	t	t
40	119,0*	154,0*	-	-	-	-	-	-	-	-	-
42	112,0*	154,0*	-	-	-	-	-	-	-	-	-
46	99,0*	151,0*	-	-	-	-	-	-	-	-	-
48	93,5*	155,0	-	-	-	-	-	-	-	-	-
50	88,0*	154,0	-	-	-	-	-	-	-	154,0	-
54	78,5*	152,0	-	-	-	-	-	-	-	154,0	-
58	70,0*	150,0	-	-	-	-	-	-	-	152,0	-
62	62,5*	148,0	-	-	-	-	-	-	-	151,0	-
66	55,5*	146,0	-	-	-	-	-	-	-	149,0	-
70	49,8*	145,0	-	-	-	-	-	-	-	147,0	-
74	44,4*	143,0	143,0	-	-	-	-	-	-	144,0	-
78	39,3*	131,0	143,0	-	-	-	-	-	-	142,0	-
82	34,1*	120,0	143,0	-	-	-	-	-	-	139,0	-
86	29,5*	110,0	135,0	-	-	-	-	-	-	137,0	-
90	25,3*	101,0	124,0	-	-	-	-	-	-	135,0	-
94	21,5*	93,0	113,0	-	-	-	-	-	-	132,0	-
98	18,1*	85,5	104,0	124,0	-	-	-	-	-	125,0	-
100	16,6*	82,0	100,0	121,0	-	-	-	-	-	121,5	-
102	15,1*	78,7	96,0	116,0	-	-	-	-	-	118,0	-
106	12,4*	72,7	88,0	106,0	-	-	-	-	-	112,0	-
108	11,1*	70,0	84,5	102,0	-	-	-	-	-	109,0	-
110	-	-	81,0	97,5	-	-	-	-	-	106,0	-
114	-	-	75,0	90,0	-	-	-	-	-	101,0	-
118	-	-	69,0	83,0	-	-	-	-	-	96,5	-
120	-	-	66,5	79,5	94,5	-	-	-	-	93,7	-
122	-	-	-	76,5	90,5	-	-	-	-	91,0	-
126	-	-	-	70,5	83,5	-	-	-	-	84,5	-
128	-	-	-	68,0	80,0	-	-	-	-	80,7	-
130	-	-	-	-	77,0	-	-	-	-	77,0	-
134	-	-	-	-	71,0	-	-	-	-	68,5	-
136	-	-	-	-	68,5	-	-	-	-	64,0	-
138	-	-	-	-	-	62,0	-	-	-	59,5	-
142	-	-	-	-	-	58,5	-	-	-	51,5	-
144	-	-	-	-	-	57,0	-	-	-	47,3	-
146	-	-	-	-	-	-	43,2	-	-	-	-
150	-	-	-	-	-	-	34,8	-	-	-	-

0 t 100 t 180 t 240 t 340 t 440 t 540 t 640 t

6 m steps of luffing jib is standard · 6 m Stufung der Wippe ist Standard · Des paliers de 6 m sont de série pour la fléchette · Falcone standard con sezioni di 6 m · Incrementos de 6 m para plumín abatible son estándar · Lances de 6 m da lança auxiliar como padrão · 6 м шаг размера гуська является стандартом

* Main boom angle 88° · Hauptauslegerwinkel 88° · Jarret de flèche principale 88° · Inclinazione braccio base 88° · Ángulo de pluma principal 88° · Ángulo da lança principal 88° · Угол подъема гл. стрелы 88°

Main boom angle 88°, 85°, 75°, 65°, 55° and 45°; capacities for intermediate boom positions are calculated by the crane control system IC-1 · Hauptauslegerwinkel 88°, 85°, 75°, 65°, 55° und 45°; Traglasten für Zwischenstellungen des Hauptauslegers werden von der Kransteuerung IC-1 berechnet

Jarret de flèche principale 88°, 85°, 75°, 65°, 55° et 45°; le système de commande de la grue IC-1 calcule les charges pour les positions intermédiaires de la flèche

Inclinazione braccio base 88°, 85°, 75°, 65°, 55° e 45°; capacità per posizioni intermedie del braccio sono calcolate dal sistema di controllo della gru IC-1

Ángulo de pluma principal 88°, 85°, 75°, 65°, 55° y 45° las capacidades para posiciones de pluma intermedias son calculadas por el sistema de control de grúa IC-1

Ângulos da lança principal 88°, 85°, 75°, 65°, 55° e 45°; as capacidades para posições da lança intermediária são calculadas pelo sistema de controle da grua IC-1

Грузоподъемность при углах подъема главной стрелы 88°, 85°, 75°, 65°, 55° и 45°, грузоподъемность в промежуточных положениях стрелы рассчитывается системой управления краном IC-1

295 t + 60 t								19-30 m								10,5 m								9.8 m/s								360°								ISO																																																																																																																																																																																																																												
60 m + 48 m								SWSL								SFSL								60 m + 60 m								SWSL								SFSL																																																																																																																																																																																																																												
0 t								0 t - 640 t								0 t								0 t - 640 t								0 t								0 t - 640 t																																																																																																																																																																																																																												
88°/85°								88°/85°								75°								65°								55°								45°								88°/85°								88°/85°								75°								65°								55°								45°																																																																																																																																																																												
m	t	t	t	t	t	t	t	m	t	t	t	t	t	t	t	m	t	t	t	t	t	t	t	m	t	t	t	t	t	t	t	m	t	t	t	t	t	t	t	m	t	t	t	t	t	t	t	m	t	t	t	t	t	t	t																																																																																																																																																																																																													
22	301,0*	457,0*	-	-	-	-	-	26	242,0*	364,0*	-	-	-	-	-	30	209,0*	350,0*	-	-	-	-	-	-	-	-	34	183,0*	376,0	-	-	-	-	-	38	162,0*	367,0	-	-	-	-	-	-	42	145,0*	357,0	-	-	-	-	-	-	46	130,0*	333,0	-	-	-	-	-	-	50	115,0*	295,0	-	-	-	-	-	-	54	102,0*	264,0	360,0	-	-	-	-	-	58	92,0*	238,0	316,0	-	-	-	-	-	62	83,0*	216,0	282,0	-	-	-	-	-	66	70,0	182,0	253,0	-	-	-	-	-	69	-	-	234,5	286,0	-	-	-	-	70	-	-	229,0	282,0	-	-	-	-	74	-	-	208,0	264,0	-	-	-	-	76	-	-	199,0	252,0	-	-	-	-	78	-	-	-	240,0	-	-	-	-	82	-	-	-	218,0	-	-	-	-	86	-	-	-	199,0	198,0	-	-	-	-	89	-	-	-	-	-	-	-	-	90	-	-	-	-	-	-	-	-	92	-	-	-	-	-	-	-	-	94	-	-	-	-	-	-	-	-	98	-	-	-	-	-	-	-	-	102	-	-	-	-	-	-	-	-	103	-	-	-	-	-	-	-	-	106	-	-	-	-	-	-	-	-	110	-	-	-	-	-	-	-	-	110	-	-	-	-	-	-	-	-



6 m steps of luffing jib is standard · 6 m Stufung der Wippe ist Standard · Des paliers de 6 m sont de série pour la fléchette · Falcone standard con sezioni di 6 m · Incrementos de 6 m para plumín abatible son estándar · Lances de 6 m da lança auxiliar como padrão · 6 м шаг размера гуська является стандартом

* Main boom angle 88° · Hauptauslegerwinkel 88° · Jarret de flèche principale 88° · Inclinazione braccio base 88° · Ángulo de pluma principal 88° · Ángulo da lança principal 88° · Угол подъема гл. стрелы 88°

Main boom angle 88°, 85°, 75°, 65°, 55° and 45°; capacities for intermediate boom positions are calculated by the crane control system IC-1 · Hauptauslegerwinkel 88°, 85°, 75°, 65°, 55° und 45°; Traglasten für Zwischenstellungen des Hauptauslegers werden von der Kransteuerung IC-1 berechnet

Jarret de flèche principale 88°, 85°, 75°, 65°, 55° et 45°; le système de commande de la grue IC-1 calcule les charges pour les positions intermédiaires de la flèche

Inclinazione braccio base 88°, 85°, 75°, 65°, 55° e 45°, capacità per posizioni intermedie del braccio sono calcolate dal sistema di controllo della gru IC-1

Ángulo de pluma principal 88°, 85°, 75°, 65°, 55° y 45° las capacidades para posiciones de pluma intermedias son calculadas por el sistema de control de grúa IC-1

Ángulos da lança principal 88°, 85°, 75°, 65°, 55° e 45°, as capacidades para posições da lança intermediária são calculadas pelo sistema de controle da grua IC-1

Грузоподъемность при углах подъема главной стрелы 88°, 85°, 75°, 65°, 55° и 45°, грузоподъемность в промежуточных положениях стрелы рассчитывается системой управления краном IC-1

295 t + 60 t									19-30 m									10,5 m									9.8 m/s									360°									ISO								
60 m + 72 m									SWSL									SFSL									60 m + 84 m									SWSL									SFSL								
0 t									0 t - 640 t									0 t									0 t - 640 t									0 t									0 t - 640 t								
88°/85°			88°/85°			75°			65°			55°			45°			88°/85°			88°/85°			75°			65°			55°			45°																				
m	t	t	t	t	t	t	t	t	m	t	t	t	t	t	t	t	t	m	t	t	t	t	t	t	t	t	m	t	t	t	t	t	t	t	t																		
30	197,0*	293,0*	-	-	-	-	-	-	32	171,0*	237,0*	-	-	-	-	-	-	34	160,0*	236,0*	-	-	-	-	-	-	-	-	-																								
34	173,0*	284,0*	-	-	-	-	-	-	34	160,0*	236,0*	-	-	-	-	-	-	38	141,0*	230,0*	-	-	-	-	-	-	-	-	-																								
36	162,0*	304,0	-	-	-	-	-	298,0	38	141,0*	230,0*	-	-	-	-	-	-	40	133,0*	244,0	-	-	-	-	-	-	-	-	-																								
38	153,0*	303,0	-	-	-	-	-	298,0	40	133,0*	244,0	-	-	-	-	-	-	42	125,0*	243,0	-	-	-	-	-	-	-	-	240,0																								
42	136,0*	297,0	-	-	-	-	-	298,0	42	125,0*	243,0	-	-	-	-	-	-	46	112,0*	240,0	-	-	-	-	-	-	-	-	240,0																								
46	122,0*	292,0	-	-	-	-	-	298,0	46	112,0*	240,0	-	-	-	-	-	-	50	100,0*	236,0	-	-	-	-	-	-	-	-	240,0																								
50	110,0*	285,0	-	-	-	-	-	298,0	50	100,0*	236,0	-	-	-	-	-	-	54	90,0*	232,0	-	-	-	-	-	-	-	-	240,0																								
54	99,5*	266,0	-	-	-	-	-	295,0	54	90,0*	232,0	-	-	-	-	-	-	58	81,5*	228,0	-	-	-	-	-	-	-	-	240,0																								
58	89,0*	239,0	310,0	-	-	-	-	286,0	58	81,5*	228,0	-	-	-	-	-	-	62	73,5*	210,0	-	-	-	-	-	-	-	-	235,0																								
62	80,0*	216,0	284,0	-	-	-	-	278,0	62	73,5*	210,0	-	-	-	-	-	-	64	70,0*	200,0	242,0	-	-	-	-	-	-	-	232,0																								
66	72,0*	197,0	254,0	-	-	-	-	268,0	64	70,0*	200,0	242,0	-	-	-	-	-	66	66,0*	190,0	242,0	-	-	-	-	-	-	-	229,0																								
70	65,0*	180,0	229,0	-	-	-	-	260,0	66	66,0*	190,0	242,0	-	-	-	-	-	70	59,0*	173,0	223,0	-	-	-	-	-	-	-	223,0																								
74	59,0*	158,0	208,0	-	-	-	-	251,0	70	59,0*	173,0	223,0	-	-	-	-	-	74	52,5*	159,0	202,0	-	-	-	-	-	-	-	217,0																								
76	50,5	147,0	199,0	-	-	-	-	245,5	74	52,5*	159,0	202,0	-	-	-	-	-	78	46,8*	146,0	183,0	-	-	-	-	-	-	-	211,0																								
77	-	-	194,5	243,0	-	-	-	242,7	78	46,8*	146,0	183,0	-	-	-	-	-	82	41,8*	133,0	167,0	-	-	-	-	-	-	-	204,0																								
78	-	-	190,0	241,0	-	-	-	240,0	82	41,8*	133,0	167,0	-	-	-	-	-	84	39,5*	126,0	160,0	-	-	-	-	-	-	-	198,5																								
82	-	-	174,0	218,0	-	-	-	223,0	84	39,5*	126,0	160,0	-	-	-	-	-	86	32,3	117,5	153,0	192,0	-	-	-	-	-	-	193,0																								
86	-	-	160,0	198,0	-	-	-	207,0	86	32,3	117,5	153,0	192,0	-	-	-	-	88	30,4	109,0	147,0	183,0	-	-	-	-	-	-	188,5																								
90	-	-	-	181,0	-	-	-	188,0	88	30,4	109,0	147,0	183,0	-	-	-	-	90	-	-	141,0	175,0	-	-	-	-	-	-	184,0																								
94	-	-	-	166,0	-	-	-	171,0	90	-	-	141,0	175,0	-	-	-	-	94	-	-	130,0	160,0	-	-	-	-	-	-	175,0																								
95	-	-	-	162,5	168,0	-	-	167,0	94	-	-	130,0	160,0	-	-	-	-	98	-	-	120,0	147,0	-	-	-	-	-	-	159,0																								
96	-	-	-	159,0	166,0	-	-	163,0	98	-	-	120,0	147,0	-	-	-	-	102	-	-	-	135,0	-	-	-	-	-	-	145,0																								
98	-	-	-	-	161,0	-	-	155,0	102	-	-	-	135,0	-	-	-	-	104	-	-	-	130,0	139,0	-	-	-	-	-	138,0																								
102	-	-	-	-	152,0	-	-	139,0	104	-	-	-	130,0	139,0	-	-	-	106	-	-	-	125,0	135,0	-	-	-	-	-	131,0																								
106	-	-	-	-	144,0	-	-	125,0	106	-	-	-	125,0	135,0	-	-	-	108	-	-	-	120,0	131,0	-	-	-	-	-	124,5																								
110	-	-	-	-	-	-	-	115,0	108	-	-	-	120,0	131,0	-	-	-	110	-	-	-	-	127,0	-	-	-	-	-	118,0																								
114	-	-	-	-	-	-	-	110,0	110	-	-	-	-	127,0	-	-	-	114	-	-	-	-	121,0	-	-	-	-	-	105,0																								
118	-	-	-	-	-	-	-	93,0	114	-	-	-	-	121,0	-	-	-	118	-	-	-	-	115,0	-	-	-	-	-	96,0																								
122	-	-	-	-	-	-	-	80,0	118	-	-	-	-	115,0	-	-	-	120	-	-	-	-	-	-	-	-	-	93,5	92,7																								
									120	-	-	-	-	-	-	-	-	122	-	-	-	-	-	-	-	-	-	91,5	89,5																								
									122	-	-	-	-	-	-	-	-	126	-	-	-	-	-	-	-	-	-	87,0	79,0																								
									126	-	-	-	-	-	-	-	-	130	-	-	-	-	-	-	-	-	-	-	68,0																								
									130	-	-	-	-	-	-	-	-	134	-	-	-	-	-	-	-	-	-	-	57,0																								
									134	-	-	-	-	-	-	-	-																																				



6 m steps of luffing jib is standard · 6 m Stufung der Wippe ist Standard · Des paliers de 6 m sont de série pour la fléchette · Falcone standard con sezioni di 6 m · Incrementos de 6 m para plumín abatible son estándar · Lances de 6 m da lança auxiliar como padrão · 6 м шаг размера гуська является стандартом

* Main boom angle 88° · Hauptauslegerwinkel 88° · Jarret de flèche principale 88° · Inclinação braccio base 88° · Ângulo de pluma principal 88° · Ângulo da lança principal 88° · Угол подъема гл. стрелы 88°

Main boom angle 88°, 85°, 75°, 65°, 55° and 45°; capacities for intermediate boom positions are calculated by the crane control system IC-1 · Hauptauslegerwinkel 88°, 85°, 75°, 65°, 55° und 45°; Traglasten für Zwischenstellungen des Hauptauslegers werden von der Kransteuerung IC-1 berechnet

Jarret de flèche principale 88°, 85°, 75°, 65°, 55° et 45°; le système de commande de la grue IC-1 calcule les charges pour les positions intermédiaires de la flèche

Inclinação braccio base 88°, 85°, 75°, 65°, 55° e 45°, capacità per posizioni intermedie del braccio sono calcolate dal sistema di controllo della gru IC-1

Ângulo de pluma principal 88°, 85°, 75°, 65°, 55° y 45° las capacidades para posiciones de pluma intermedias son calculadas por el sistema de control de grúa IC-1

Ângulos da lança principal 88°, 85°, 75°, 65°, 55° e 45°; as capacidades para posições da lança intermediária são calculadas pelo sistema de controle da grua IC-1

Грузоподъемность при углах подъема главной стрелы 88°, 85°, 75°, 65°, 55° и 45°, грузоподъемность в промежуточных положениях стрелы рассчитывается системой управления краном IC-1

295 t + 60 t								19-30 m								10,5 m								9.8 m/s								360°								ISO							
60 m + 96 m								SWSL								SFSL								60 m + 108 m								SWSL								SFSL							
0 t								0 t - 640 t								0 t								0 t - 640 t								0 t								0 t - 640 t							
88°/85°								88°/85°								75°								65°								55°								45°							
m	t	t	t	t	t	t	t	m	t	t	t	t	t	t	t	m	t	t	t	t	t	t	t	m	t	t	t	t	t	t	t	m	t	t	t	t	t	t	t								
36	140,0*	190,0*	-	-	-	-	-	40	115,0*	147,0*	-	-	-	-	-	42	108,0*	146,0*	-	-	-	-	-	-	-	-	46	96,0*	143,0*	-	-	-	-	-													
38	132,0*	189,0*	-	-	-	-	-	44	110,0*	193,0	-	-	-	-	-	46	96,0*	143,0*	-	-	-	-	-	-	-	-	48	90,0*	147,0	-	-	-	-	-													
42	116,0*	185,0*	-	-	-	-	-	46	103,0*	193,0	-	-	-	-	-	50	85,0*	147,0	-	-	-	-	-	-	-	50	85,0*	147,0	-	-	-	-	-														
44	110,0*	193,0	-	-	-	-	-	50	92,5*	190,0	-	-	-	-	-	54	75,5*	145,0	-	-	-	-	-	-	-	54	75,5*	145,0	-	-	-	-	-														
46	103,0*	193,0	-	-	-	-	-	54	83,0*	188,0	-	-	-	-	-	58	67,5*	144,0	-	-	-	-	-	-	-	58	67,5*	144,0	-	-	-	-	-														
50	92,5*	190,0	-	-	-	-	-	58	74,5*	186,0	-	-	-	-	-	62	60,0*	142,0	-	-	-	-	-	-	-	62	60,0*	142,0	-	-	-	-	-														
54	83,0*	188,0	-	-	-	-	-	62	66,5*	184,0	-	-	-	-	-	66	53,5*	140,0	-	-	-	-	-	-	-	66	53,5*	140,0	-	-	-	-	-														
58	74,5*	186,0	-	-	-	-	-	66	60,0*	181,0	-	-	-	-	-	70	47,8*	138,0	-	-	-	-	-	-	-	70	47,8*	138,0	-	-	-	-	-														
62	66,5*	184,0	-	-	-	-	-	70	54,0*	171,0	185,0	-	-	-	-	74	42,5*	137,0	-	-	-	-	-	-	-	74	42,5*	137,0	-	-	-	-	-														
66	60,0*	181,0	-	-	-	-	-	74	48,7*	156,0	185,0	-	-	-	-	76	40,0*	136,0	135,0	-	-	-	-	-	-	76	40,0*	136,0	135,0	-	-	-	-														
70	54,0*	171,0	185,0	-	-	-	-	78	43,5*	143,0	181,0	-	-	-	-	78	37,7*	135,0	135,0	-	-	-	-	-	-	78	37,7*	135,0	135,0	-	-	-	-														
74	48,7*	156,0	185,0	-	-	-	-	82	38,3*	131,5	165,0	-	-	-	-	82	33,2*	127,0	135,0	-	-	-	-	-	-	82	33,2*	127,0	135,0	-	-	-	-														
78	43,5*	143,0	181,0	-	-	-	-	86	33,7*	121,0	151,0	-	-	-	-	86	28,9*	116,5	135,0	-	-	-	-	-	-	86	28,9*	116,5	135,0	-	-	-	-														
82	38,3*	131,5	165,0	-	-	-	-	90	29,6*	111,5	138,0	-	-	-	-	90	24,7*	107,5	134,0	-	-	-	-	-	-	90	24,7*	107,5	134,0	-	-	-	-														
86	33,7*	121,0	151,0	-	-	-	-	92	27,7*	107,0	133,0	165,0	-	-	-	94	21,0*	99,0	123,0	-	-	-	-	-	-	94	21,0*	99,0	123,0	-	-	-	-														
90	29,6*	111,5	138,0	-	-	-	-	94	25,9*	101,5	127,0	158,0	-	-	-	98	17,6*	91,2	113,0	-	-	-	-	-	-	98	17,6*	91,2	113,0	-	-	-	-														
92	27,7*	107,0	133,0	165,0	-	-	-	96	24,2*	96,0	122,0	151,0	-	-	-	100	16,0*	87,5	108,0	119,0	-	-	-	-	-	100	16,0*	87,5	108,0	119,0	-	-	-														
94	25,9*	101,5	127,0	158,0	-	-	-	98	18,1	89,7	117,0	144,0	-	-	-	102	14,5*	84,0	104,0	119,0	-	-	-	-	-	102	14,5*	84,0	104,0	119,0	-	-	-														
96	24,2*	96,0	122,0	151,0	-	-	-	100	16,7	83,5	113,0	138,0	-	-	-	106	11,8*	75,7	95,5	117,0	-	-	-	-	-	106	11,8*	75,7	95,5	117,0	-	-	-														
98	18,1	89,7	117,0	144,0	-	-	-	102	-	-	108,0	133,0	-	-	-	108	10,6*	71,0	92,0	112,0	-	-	-	-	-	108	10,6*	71,0	92,0	112,0	-	-	-														
100	16,7	83,5	113,0	138,0	-	-	-	106	-	-	100,0	122,0	-	-	-	110	-	-	88,0	108,0	-	-	-	-	-	110	-	-	88,0	108,0	-	-	-														
102	-	-	108,0	133,0	-	-	-	110	-	-	93,0	113,0	-	-	-	114	-	-	81,5	99,5	-	-	-	-	-	114	-	-	81,5	99,5	-	-	-														
106	-	-	100,0	122,0	-	-	-	114	-	-	104,0	116,0	-	-	-	118	-	-	75,5	92,0	-	-	-	-	-	118	-	-	75,5	92,0	-	-	-														
110	-	-	93,0	113,0	-	-	-	118	-	-	96,5	109,0	-	-	-	122	-	-	69,5	85,0	97,0	-	-	-	-	122	-	-	69,5	85,0	97,0	-	-														
114	-	-	104,0	116,0	-	-	-	120	-	-	93,0	106,0	-	-	-	126	-	-	-	78,5	91,5	-	-	-	-	126	-	-	-	78,5	91,5	-	-														
118	-	-	104,0	116,0	-	-	-	122	-	-	103,0	103,0	-	-	-	130	-	-	-	72,5	86,5	-	-	-	-	130	-	-	-	72,5	86,5	-	-														
120	-	-	93,0	106,0	-	-	-	126	-	-	98,0	98,0	-	-	-	132	-	-	-	70,0	83,5	-	-	-	-	132	-	-	-	70,0	83,5	-	-														
122	-	-	103,0	103,0	-	-	-	128	-	-	95,0	95,0	-	-	-	134	-	-	-	-	80,5	-	-	-	-	134	-	-	-	80,5	-	-	-														
126	-	-	98,0	98,0	-	-	-	130	-	-	77,5	76,5	-	-	-	138	-	-	-	-	74,5	-	-	-	-	138	-	-	-	74,5	-	-	-														
128	-	-	95,0	95,0	-	-	-	134	-	-	73,5	69,0	-	-	-	140	-	-	-	-	71,5	-	-	-	-	140	-	-	-	71,5	-	-	-														
130	-	-	77,5	76,5	-	-	-	136	-	-	72,0	64,2	-	-	-	142	-	-	-	-	-	-	-	-	-	142	-	-	-	-	-	-	-														
134	-	-	73,5	69,0	-	-	-	138	-	-	59,5	59,5	-	-	-	146	-	-	-	-	-	-	-	-	-	146	-	-	-	-	-	-	-														
136	-	-	72,0	64,2	-	-	-	142	-	-	50,0	50,0	-	-	-	148	-	-	-	-	-	-	-	-	-	148	-	-	-	-	-	-	-														
138	-	-	59,5	59,5	-	-	-	144	-	-	50,0	50,0	-	-	-	150	-	-	-	-	-	-	-	-	-	150	-	-	-	-	-	-	-														
142	-	-	50,0	50,0	-	-	-	148	-	-	50,0	50,0	-	-	-	154	-	-	-	-	-	-	-	-	-	154	-	-	-	-	-	-	-														

0 t 100 t 180 t 240 t 340 t 440 t 540 t 640 t

6 m steps of luffing jib is standard · 6 m Stufung der Wippe ist Standard · Des paliers de 6 m sont de série pour la fléchette · Falcone standard con sezioni di 6 m · Incrementos de 6 m para plumín abatible son estándar · Lancas de 6 m da lança auxiliar como padrão · 6 м шаг размера гуська является стандартом

* Main boom angle 88° · Hauptauslegerwinkel 88° · Jarret de flèche principale 88° · Inclinazione braccio base 88° · Ángulo de pluma principal 88° · Ângulo da lança principal 88° · Угол подъема гл. стрелы 88°

Main boom angle 88°, 85°, 75°, 65°, 55° and 45°; capacities for intermediate boom positions are calculated by the crane control system IC-1
Hauptauslegerwinkel 88°, 85°, 75°, 65°, 55° und 45°; Traglasten für Zwischenstellungen des Hauptauslegers werden von der Kransteuerung IC-1 berechnet

Jarret de flèche principale 88°, 85°, 75°, 65°, 55° et 45°; le système de commande de la grue IC-1 calcule les charges pour les positions intermédiaires de la flèche

Inclinazione braccio base 88°, 85°, 75°, 65°, 55° e 45°; capacità per posizioni intermedie del braccio sono calcolate dal sistema di controllo della gru IC-1

Ángulo de pluma principal 88°, 85°, 75°, 65°, 55° y 45° las capacidades para posiciones de pluma intermedias son calculadas por el sistema de control de grúa IC-1

Ângulos da lança principal 88°, 85°, 75°, 65°, 55° e 45°; as capacidades para posições da lança intermediária são calculadas pelo sistema de controle da grua IC-1

Грузоподъемность при углах подъема главной стрелы 88°, 85°, 75°, 65°, 55° и 45°, грузоподъемность в промежуточных положениях стрелы рассчитывается системой управления краном IC-1

295 t + 60 t								19-30 m								10,5 m								9.8 m/s								360°								ISO																																																							
66 m + 36 m								SWSL								SFSL								66 m + 48 m								SWSL								SFSL																																																							
0 t								0 t - 640 t								0 t								0 t - 640 t								0 t								0 t - 640 t																																																							
88°/85°								88°/85°								75°								65°								55°								45°								88°/85°								88°/85°								75°								65°								55°								45°							
m	t	t	t	t	t	t	t	m	t	t	t	t	t	t	t	m	t	t	t	t	t	t	t	m	t	t	t	t	t	t	t	m	t	t	t	t	t	t	t																																																								
18	376,0*	536,0*	-	-	-	-	-	22	292,0*	424,0*	-	-	-	-	-	24	269,0*	419,0*	-	-	-	-	-	-	-	-	26	248,0*	408,0*	-	-	-	-	-																																																													
20	341,0*	528,0*	-	-	-	-	-	28	231,0*	445,0	-	-	-	-	-	30	215,0*	441,0	-	-	-	-	-	-	-	-	34	189,0*	427,0	-	-	-	-	-																																																													
22	311,0*	511,0*	-	-	-	-	-	38	167,0*	412,0	-	-	-	-	-	42	148,0*	368,0	-	-	-	-	-	-	-	46	130,0*	321,0	-	-	-	-	-																																																														
24	286,0*	562,0	-	-	-	-	546,0	46	130,0*	321,0	-	-	-	-	-	47	126,0*	311,5	441,0	-	-	-	-	-	50	115,0*	285,0	417,0	-	-	-	-																																																															
26	265,0*	551,0	-	-	-	-	546,0	54	95,5	255,0	360,0	-	-	-	-	58	-	-	316,0	-	-	-	-	-	62	-	-	280,0	-	-	-	-																																																															
28	246,0*	539,0	-	-	-	-	546,0	62	-	-	280,0	-	-	-	64	-	-	265,0	308,0	-	-	-	-	-	66	-	-	251,0	297,0	-	-	-																																																															
30	229,0*	528,0	-	-	-	-	546,0	70	-	-	278,0	-	-	-	74	-	-	261,0	-	-	-	-	-	-	77	-	-	249,0	-	-	-	-																																																															
34	201,0*	469,0	-	-	-	-	546,0	78	-	-	-	-	-	-	80	-	-	-	-	-	-	-	-	-	82	-	-	-	-	-	-	-																																																															
38	174,0*	396,0	-	-	-	-	538,0	86	-	-	-	-	-	-	86	-	-	-	-	-	-	-	-	-	87	-	-	-	-	-	-	-																																																															
40	161,0*	367,0	-	-	-	-	527,0	90	-	-	-	-	-	-	87	-	-	-	-	-	-	-	-	-	90	-	-	-	-	-	-	-																																																															
41	147,5	354,5	537,0	-	-	-	520,0	93	-	-	-	-	-	-	90	-	-	-	-	-	-	-	-	-	93	-	-	-	-	-	154,0	152,7																																																															
42	142,0	342,0	530,0	-	-	-	513,0	94	-	-	-	-	-	-	93	-	-	-	-	-	-	-	-	-	94	-	-	-	-	-	152,0	148,0																																																															
46	-	-	457,0	-	-	-	468,0	96	-	-	-	-	-	-	96	-	-	-	-	-	-	-	-	-	98	-	-	-	-	-	148,0	139,0																																																															
50	-	-	388,0	-	-	-	421,0	98	-	-	-	-	-	-	98	-	-	-	-	-	-	-	-	-	102	-	-	-	-	-	-	133,0																																																															
54	-	-	335,0	-	-	-	381,0	102	-	-	-	-	-	-	-	-	-	-	-	-	-	-	-	-	-	-	-	-	-	-	-	123,0																																																															
56	-	-	-	366,0	-	-	363,5	-	-	-	-	-	-	-	-	-	-	-	-	-	-	-	-	-	-	-	-	-	-	-	-	-																																																															
58	-	-	-	352,0	-	-	346,0	-	-	-	-	-	-	-	-	-	-	-	-	-	-	-	-	-	-	-	-	-	-	-	-	-																																																															
62	-	-	-	326,0	-	-	316,0	-	-	-	-	-	-	-	-	-	-	-	-	-	-	-	-	-	-	-	-	-	-	-	-	-																																																															
66	-	-	-	304,0	-	-	290,0	-	-	-	-	-	-	-	-	-	-	-	-	-	-	-	-	-	-	-	-	-	-	-	-	-																																																															
70	-	-	-	-	-	-	267,0	-	-	-	-	-	-	-	-	-	-	-	-	-	-	-	-	-	-	-	-	-	-	-	-	-																																																															
71	-	-	-	-	-	264,0	260,5	-	-	-	-	-	-	-	-	-	-	-	-	-	-	-	-	-	-	-	-	-	-	-	-	-																																																															
74	-	-	-	-	-	252,0	241,0	-	-	-	-	-	-	-	-	-	-	-	-	-	-	-	-	-	-	-	-	-	-	-	-	-																																																															
76	-	-	-	-	-	244,0	228,0	-	-	-	-	-	-	-	-	-	-	-	-	-	-	-	-	-	-	-	-	-	-	-	-	-																																																															
78	-	-	-	-	-	-	215,0	-	-	-	-	-	-	-	-	-	-	-	-	-	-	-	-	-	-	-	-	-	-	-	-	-																																																															
82	-	-	-	-	-	-	190,0	-	-	-	-	-	-	-	-	-	-	-	-	-	-	-	-	-	-	-	-	-	-	-	-	-																																																															
86	-	-	-	-	-	-	167,0	-	-	-	-	-	-	-	-	-	-	-	-	-	-	-	-	-	-	-	-	-	-	-	-	-																																																															
90	-	-	-	-	-	-	153,0	-	-	-	-	-	-	-	-	-	-	-	-	-	-	-	-	-	-	-	-	-	-	-	-	-																																																															

0 t 100 t 180 t 240 t 340 t 440 t 540 t 640 t

6 m steps of luffing jib is standard · 6 m Stufung der Wippe ist Standard · Des paliers de 6 m sont de série pour la fléchette · Falcone standard con sezioni di 6 m · Incrementos de 6 m para plumín abatible son estándar · Lances de 6 m da lança auxiliar como padrão · 6 м шаг размера гуська является стандартом

* Main boom angle 88° · Hauptauslegerwinkel 88° · Jarret de flèche principale 88° · Inclinazione braccio base 88° · Ángulo de pluma principal 88° · Ángulo da lança principal 88° · Угол подъема гл. стрелы 88°

Main boom angle 88°, 85°, 75°, 65°, 55° and 45°; capacities for intermediate boom positions are calculated by the crane control system IC-1 · Hauptauslegerwinkel 88°, 85°, 75°, 65°, 55° und 45°; Traglasten für Zwischenstellungen des Hauptauslegers werden von der Kransteuerung IC-1 berechnet

Jarret de flèche principale 88°, 85°, 75°, 65°, 55° et 45°; le système de commande de la grue IC-1 calcule les charges pour les positions intermédiaires de la flèche

Inclinazione braccio base 88°, 85°, 75°, 65°, 55° e 45°; capacità per posizioni intermedie del braccio sono calcolate dal sistema di controllo della gru IC-1

Ángulo de pluma principal 88°, 85°, 75°, 65°, 55° y 45° las capacidades para posiciones de pluma intermedias son calculadas por el sistema de control de grúa IC-1

Ángulos da lança principal 88°, 85°, 75°, 65°, 55° e 45°; as capacidades para posições da lança intermediária são calculadas pelo sistema de controle da grua IC-1

Грузоподъемность при углах подъема главной стрелы 88°, 85°, 75°, 65°, 55° и 45°, грузоподъемность в промежуточных положениях стрелы рассчитывается системой управления краном IC-1

295 t + 60 t								19-30 m								10,5 m								9.8 m/s								360°								ISO																																																																																																																																																																																																																																																										
66 m + 60 m								SWSL								SFSL								66 m + 72 m								SWSL								SFSL																																																																																																																																																																																																																																																										
0 t								0 t - 640 t								0 t								0 t - 640 t								0 t								0 t - 640 t																																																																																																																																																																																																																																																										
88°/85°								88°/85°								75°								65°								55°								45°								88°/85°								88°/85°								75°								65°								55°								45°																																																																																																																																																																																																										
m	t	t	t	t	t	t	t	m	t	t	t	t	t	t	t	m	t	t	t	t	t	t	t	m	t	t	t	t	t	t	t	m	t	t	t	t	t	t	t	m	t	t	t	t	t	t	t	m	t	t	t	t	t	t	t																																																																																																																																																																																																																																											
26	234,0*	344,0*	-	-	-	-	-	30	191,0*	277,0*	-	-	-	-	-	34	168,0*	269,0*	-	-	-	-	-	-	-	-	36	157,0*	288,0	-	-	-	-	-	38	148,0*	287,0	-	-	-	-	-	-	42	132,0*	282,0	-	-	-	-	-	-	46	118,0*	276,0	-	-	-	-	-	-	50	107,0*	270,0	-	-	-	-	-	-	54	97,0*	264,0	-	-	-	-	-	-	58	88,0*	244,0	-	-	-	-	-	-	60	84,0*	232,0	295,0	-	-	-	-	-	62	79,5*	220,0	293,0	-	-	-	-	-	66	71,5*	200,0	267,0	-	-	-	-	-	70	64,5*	183,0	240,0	-	-	-	-	-	74	58,5*	162,0	217,0	-	-	-	-	-	78	47,0	139,0	198,0	-	-	-	-	-	80	-	-	189,0	230,0	-	-	-	-	82	-	-	181,0	223,0	-	-	-	-	86	-	-	166,0	210,0	-	-	-	-	88	-	-	159,0	202,0	-	-	-	-	90	-	-	-	193,0	-	-	-	-	94	-	-	-	177,0	-	-	-	-	98	-	-	-	162,0	162,0	-	-	-	100	-	-	-	156,0	158,0	-	-	-	102	-	-	-	-	153,0	-	-	-	106	-	-	-	-	145,0	-	-	-	110	-	-	-	-	138,0	-	-	-	114	-	-	-	-	-	107,0	-	-	118	-	-	-	-	-	101,0	-	-	119	-	-	-	-	-	100,0	-	-	122	-	-	-	-	-	-	-	-	88,0	-	-	126	-	-	-	-	-	-	-	-	76,5



6 m steps of luffing jib is standard · 6 m Stufung der Wippe ist Standard · Des paliers de 6 m sont de série pour la fléchette · Falcone standard con sezioni di 6 m · Incrementos de 6 m para plumín abatible son estándar · Lances de 6 m da lança auxiliar como padrão · 6 м шаг размера гуська является стандартом

* Main boom angle 88° · Hauptauslegerwinkel 88° · Jarret de flèche principale 88° · Inclinazione braccio base 88° · Ángulo de pluma principal 88° · Ángulo da lança principal 88° · Угол подъема гл. стрелы 88°

Main boom angle 88°, 85°, 75°, 65°, 55° and 45°; capacities for intermediate boom positions are calculated by the crane control system IC-1
 Hauptauslegerwinkel 88°, 85°, 75°, 65°, 55° und 45°; Traglasten für Zwischenstellungen des Hauptauslegers werden von der Kransteuerung IC-1 berechnet

Jarret de flèche principale 88°, 85°, 75°, 65°, 55° et 45°; le système de commande de la grue IC-1 calcule les charges pour les positions intermédiaires de la flèche

Inclinazione braccio base 88°, 85°, 75°, 65°, 55° e 45°; capacità per posizioni intermedie del braccio sono calcolate dal sistema di controllo della gru IC-1

Ángulo de pluma principal 88°, 85°, 75°, 65°, 55° y 45° las capacidades para posiciones de pluma intermedias son calculadas por el sistema de control de grúa IC-1

Ângulos da lança principal 88°, 85°, 75°, 65°, 55° e 45°; as capacidades para posições da lança intermediária são calculadas pelo sistema de controle da grua IC-1

Грузоподъемность при углах подъема главной стрелы 88°, 85°, 75°, 65°, 55° и 45°, грузоподъемность в промежуточных положениях стрелы рассчитывается системой управления краном IC-1

295 t + 60 t 19-30 m 10,5 m 9.8 m/s 360° ISO							
66 m + 84 m							
SWSL				SFSL			
0 t 0 t - 640 t				0 t 0 t - 640 t			
88°/85° 88°/85° 75° 65° 55° 45°				88°/85° 88°/85° 75° 65° 55° 45°			
m	t	t	t	t	t	t	t
32	166,0*	224,0*	-	-	-	-	-
34	155,0*	224,0*	-	-	-	-	-
38	137,0*	218,0*	-	-	-	-	-
40	129,0*	232,0	-	-	-	-	228,0
42	121,0*	232,0	-	-	-	-	228,0
46	108,0*	228,0	-	-	-	-	228,0
50	97,0*	225,0	-	-	-	-	228,0
54	87,5*	221,0	-	-	-	-	228,0
58	79,0*	217,0	-	-	-	-	228,0
62	71,0*	213,0	-	-	-	-	224,0
66	64,5*	194,0	232,0	-	-	-	219,0
70	58,0*	177,0	232,0	-	-	-	214,0
74	51,5*	161,0	211,0	-	-	-	209,0
78	46,1*	148,0	191,0	-	-	-	203,0
82	41,2*	135,0	174,0	-	-	-	198,0
84	38,9*	128,0	167,0	-	-	-	195,5
86	31,0	120,0	160,0	-	-	-	193,0
88	29,1	112,0	153,0	195,0	-	-	189,5
90	-	-	146,0	187,0	-	-	186,0
94	-	-	135,0	170,0	-	-	173,0
98	-	-	124,0	156,0	-	-	161,0
100	-	-	119,0	149,0	-	-	155,5
102	-	-	-	143,0	-	-	150,0
106	-	-	-	132,0	-	-	137,0
108	-	-	-	127,0	132,0	-	130,5
110	-	-	-	122,0	128,0	-	124,0
114	-	-	-	-	121,0	-	111,0
118	-	-	-	-	115,0	-	100,0
120	-	-	-	-	112,0	-	94,2
122	-	-	-	-	-	-	88,5
124	-	-	-	-	-	84,0	83,0
126	-	-	-	-	-	81,5	78,5
130	-	-	-	-	-	77,0	72,5
134	-	-	-	-	-	-	64,0
138	-	-	-	-	-	-	54,0
36	136,0*	181,0*	-	-	-	-	-
38	127,0*	180,0*	-	-	-	-	-
42	113,0*	176,0*	-	-	-	-	-
44	106,0*	185,0	-	-	-	-	183,0
46	100,0*	185,0	-	-	-	-	183,0
50	89,5*	183,0	-	-	-	-	183,0
54	80,0*	180,0	-	-	-	-	183,0
58	71,5*	178,0	-	-	-	-	183,0
62	64,5*	175,0	-	-	-	-	183,0
66	58,0*	173,0	-	-	-	-	182,0
70	52,0*	170,0	-	-	-	-	178,0
72	49,4*	167,0	178,0	-	-	-	176,5
74	46,8*	159,0	178,0	-	-	-	175,0
78	41,9*	146,0	178,0	-	-	-	172,0
82	37,5*	134,0	173,0	-	-	-	169,0
86	33,2*	123,0	157,0	-	-	-	166,0
90	29,0*	113,5	144,0	-	-	-	162,0
94	25,4*	103,7	132,0	-	-	-	159,0
96	23,7*	98,5	127,0	159,0	-	-	157,0
98	16,9	92,0	122,0	147,0	-	-	155,0
100	15,5	85,5	117,0	147,0	-	-	152,5
102	-	-	112,0	141,0	-	-	150,0
106	-	-	104,0	130,0	-	-	140,0
110	-	-	96,5	119,0	-	-	131,0
112	-	-	92,5	115,0	-	-	125,0
114	-	-	-	110,0	-	-	119,0
118	-	-	-	102,0	110,0	-	107,0
122	-	-	-	94,5	104,0	-	97,0
126	-	-	-	-	98,5	-	86,5
130	-	-	-	-	93,5	-	76,5
132	-	-	-	-	91,5	-	71,7
134	-	-	-	-	-	-	67,0
136	-	-	-	-	-	65,5	64,2
138	-	-	-	-	-	64,0	61,5
140	-	-	-	-	-	62,5	58,5
142	-	-	-	-	-	-	55,5
146	-	-	-	-	-	-	46,9
150	-	-	-	-	-	-	37,9

0 t 100 t 180 t 240 t 340 t 440 t 540 t 640 t

6 m steps of luffing jib is standard · 6 m Stufung der Wippe ist Standard · Des paliers de 6 m sont de série pour la fléchette · Falcone standard con sezioni di 6 m · Incrementos de 6 m para plumín abatible son estándar · Lances de 6 m da lança auxiliar como padrão · 6 м шаг размера гуська является стандартом

* Main boom angle 88° · Hauptauslegerwinkel 88° · Jarret de flèche principale 88° · Inclinazione braccio base 88° · Ângulo de pluma principal 88° · Ângulo da lança principal 88° · Угол подъема гл. стрелы 88°

Main boom angle 88°, 85°, 75°, 65°, 55° and 45°; capacities for intermediate boom positions are calculated by the crane control system IC-1
 Hauptauslegerwinkel 88°, 85°, 75°, 65°, 55° und 45°; Traglasten für Zwischenstellungen des Hauptauslegers werden von der Kransteuerung IC-1 berechnet

Jarret de flèche principale 88°, 85°, 75°, 65°, 55° et 45°; le système de commande de la grue IC-1 calcule les charges pour les positions intermédiaires de la flèche

Inclinazione braccio base 88°, 85°, 75°, 65°, 55° e 45°; capacità per posizioni intermedie del braccio sono calcolate dal sistema di controllo della gru IC-1

Ângulo de pluma principal 88°, 85°, 75°, 65°, 55° y 45° las capacidades para posiciones de pluma intermedias son calculadas por el sistema de control de grúa IC-1

Ângulos da lança principal 88°, 85°, 75°, 65°, 55° e 45°; as capacidades para posições da lança intermediária são calculadas pelo sistema de controle da grua IC-1

Грузоподъемность при углах подъема главной стрелы 88°, 85°, 75°, 65°, 55° и 45°, грузоподъемность в промежуточных положениях стрелы рассчитывается системой управления краном IC-1

295 t + 60 t		19-30 m		10,5 m		9.8 m/s		360°		ISO	
66 m + 108 m		SWSL		SFSL		72 m + 36 m		SWSL		SFSL	
0 t		0 t - 640 t		0 t		0 t - 640 t		0 t		0 t - 640 t	
88°/85°		88°/85°		75°		65°		55°		45°	
m	t	t	t	t	t	t	t	t	t	t	t
40	111,0*	141,0*	-	-	-	-	-	-	-	-	-
42	104,0*	140,0*	-	-	-	-	-	-	-	-	-
46	92,5*	138,0*	-	-	-	-	-	-	-	-	-
48	87,0*	142,0	-	-	-	-	-	-	-	-	142,0
50	82,0*	142,0	-	-	-	-	-	-	-	-	142,0
54	73,0*	140,0	-	-	-	-	-	-	-	-	142,0
58	65,0*	139,0	-	-	-	-	-	-	-	-	141,0
62	57,5*	137,0	-	-	-	-	-	-	-	-	140,0
66	51,5*	135,0	-	-	-	-	-	-	-	-	138,0
70	45,8*	134,0	-	-	-	-	-	-	-	-	137,0
74	40,6*	132,0	-	-	-	-	-	-	-	-	135,0
78	35,9*	131,0	131,0	-	-	-	-	-	-	-	133,0
82	31,6*	127,0	131,0	-	-	-	-	-	-	-	131,0
86	27,7*	119,0	131,0	-	-	-	-	-	-	-	129,0
90	24,0*	109,0	130,0	-	-	-	-	-	-	-	126,0
94	20,4*	100,2	128,0	-	-	-	-	-	-	-	124,0
98	17,1*	92,7	117,0	-	-	-	-	-	-	-	122,0
100	15,5*	89,0	112,0	-	-	-	-	-	-	-	121,0
102	14,0*	85,5	108,0	-	-	-	-	-	-	-	120,0
104	12,6*	82,0	103,0	114,0	-	-	-	-	-	-	119,0
106	11,3*	77,5	99,5	114,0	-	-	-	-	-	-	118,0
108	10,1*	73,0	95,5	114,0	-	-	-	-	-	-	116,5
110	-	68,0	92,0	114,0	-	-	-	-	-	-	115,0
112	-	63,0	88,0	110,0	-	-	-	-	-	-	114,0
114	-	-	84,5	105,0	-	-	-	-	-	-	113,0
118	-	-	78,5	97,5	-	-	-	-	-	-	110,0
122	-	-	72,5	90,0	-	-	-	-	-	-	100,0
126	-	-	-	83,0	92,0	-	-	-	-	-	91,0
130	-	-	-	77,0	86,5	-	-	-	-	-	81,5
134	-	-	-	71,0	82,0	-	-	-	-	-	72,5
138	-	-	-	-	77,5	-	-	-	-	-	63,5
142	-	-	-	-	73,5	-	-	-	-	-	55,5
144	-	-	-	-	71,5	-	-	-	-	-	52,2
146	-	-	-	-	-	51,0	-	-	-	-	50,0
150	-	-	-	-	-	48,7	-	-	-	-	45,8
152	-	-	-	-	-	47,5	-	-	-	-	41,9
154	-	-	-	-	-	-	-	-	-	-	38,1
158	-	-	-	-	-	-	-	-	-	-	30,4
162	-	-	-	-	-	-	-	-	-	-	22,5

0 t 100 t 180 t 240 t 340 t 440 t 540 t 640 t

6 m steps of luffing jib is standard · 6 m Stufung der Wippe ist Standard · Des paliers de 6 m sont de série pour la fléchette · Falcone standard con sezioni di 6 m · Incrementos de 6 m para plumín abatible son estándar · Lances de 6 m da lança auxiliar como padrão · 6 м шаг размера гуська является стандартом

* Main boom angle 88° · Hauptauslegerwinkel 88° · Jarret de flèche principale 88° · Inclinazione braccio base 88° · Ángulo de pluma principal 88° · Ángulo da lança principal 88° · Угол подъема гл. стрелы 88°

Main boom angle 88°, 85°, 75°, 65°, 55° and 45°; capacities for intermediate boom positions are calculated by the crane control system IC-1 · Hauptauslegerwinkel 88°, 85°, 75°, 65°, 55° und 45°; Traglasten für Zwischenstellungen des Hauptauslegers werden von der Kransteuerung IC-1 berechnet

Jarret de flèche principale 88°, 85°, 75°, 65°, 55° et 45°; le système de commande de la grue IC-1 calcule les charges pour les positions intermédiaires de la flèche

Inclinazione braccio base 88°, 85°, 75°, 65°, 55° e 45°; capacità per posizioni intermedie del braccio sono calcolate dal sistema di controllo della gru IC-1

Ángulo de pluma principal 88°, 85°, 75°, 65°, 55° y 45° las capacidades para posiciones de pluma intermedias son calculadas por el sistema de control de grúa IC-1

Ángulos da lança principal 88°, 85°, 75°, 65°, 55° e 45°; as capacidades para posições da lança intermediária são calculadas pelo sistema de controle da grua IC-1

Грузоподъемность при углах подъема главной стрелы 88°, 85°, 75°, 65°, 55° и 45°, грузоподъемность в промежуточных положениях стрелы рассчитывается системой управления краном IC-1

295 t + 60 t		19-30 m		10,5 m		9.8 m/s		360°		ISO	
72 m + 48 m		SWSL		SFSL		72 m + 60 m		SWSL		SFSL	
0 t		0 t - 640 t		0 t		0 t - 640 t		0 t		0 t - 640 t	
88°/85°		88°/85°		75°		65°		55°		45°	
m	t	t	t	t	t	t	t	t	t	t	t
22	282,0*	390,0*	-	-	-	-	-	-	-	-	-
24	260,0*	385,0*	-	-	-	-	-	-	-	-	-
26	241,0*	376,0*	-	-	-	-	-	-	-	-	-
28	224,0*	409,0	-	-	-	-	-	-	-	-	-
30	209,0*	405,0	-	-	-	-	-	-	-	-	-
34	183,0*	392,0	-	-	-	-	-	-	-	-	-
38	163,0*	378,0	-	-	-	-	-	-	-	-	-
42	146,0*	365,0	-	-	-	-	-	-	-	-	-
46	129,0*	326,0	-	-	-	-	-	-	-	-	-
48	121,0*	306,0	414,0	-	-	-	-	-	-	-	-
50	114,0*	288,0	414,0	-	-	-	-	-	-	-	-
52	107,0*	272,0	407,0	-	-	-	-	-	-	-	-
54	94,0	257,0	380,0	-	-	-	-	-	-	-	-
58	-	-	331,0	-	-	-	-	-	-	-	-
62	-	-	292,0	-	-	-	-	-	-	-	-
66	-	-	261,0	-	-	-	-	-	-	-	-
67	-	-	254,0	285,0	-	-	-	-	-	-	-
68	-	-	247,0	280,0	-	-	-	-	-	-	-
70	-	-	-	271,0	-	-	-	-	-	-	-
74	-	-	-	254,0	-	-	-	-	-	-	-
78	-	-	-	239,0	-	-	-	-	-	-	-
80	-	-	-	232,0	-	-	-	-	-	-	-
82	-	-	-	-	-	-	-	-	-	-	-
83	-	-	-	-	206,0	-	-	-	-	-	-
86	-	-	-	-	197,0	-	-	-	-	-	-
90	-	-	-	-	187,0	-	-	-	-	-	-
94	-	-	-	-	-	-	-	-	-	-	-
97	-	-	-	-	-	144,0	-	-	-	-	-
98	-	-	-	-	-	142,0	-	-	-	-	-
100	-	-	-	-	-	138,0	-	-	-	-	-
102	-	-	-	-	-	-	-	-	-	-	-
106	-	-	-	-	-	-	-	-	-	-	-
26	227,0*	317,0*	-	-	-	-	-	-	-	-	-
28	211,0*	311,0*	-	-	-	-	-	-	-	-	-
30	197,0*	305,0*	-	-	-	-	-	-	-	-	-
32	184,0*	330,0	-	-	-	-	-	-	-	-	321,0
34	173,0*	328,0	-	-	-	-	-	-	-	-	321,0
38	153,0*	320,0	-	-	-	-	-	-	-	-	321,0
42	137,0*	311,0	-	-	-	-	-	-	-	-	321,0
46	123,0*	302,0	-	-	-	-	-	-	-	-	321,0
50	111,0*	293,0	-	-	-	-	-	-	-	-	321,0
54	101,0*	270,0	335,0	-	-	-	-	-	-	-	311,0
58	90,5*	243,0	333,0	-	-	-	-	-	-	-	301,0
62	81,5*	220,0	307,0	-	-	-	-	-	-	-	288,0
66	67,0	193,0	274,0	-	-	-	-	-	-	-	279,0
70	-	-	246,0	-	-	-	-	-	-	-	269,0
74	-	-	223,0	251,0	-	-	-	-	-	-	249,0
78	-	-	203,0	236,0	-	-	-	-	-	-	230,0
82	-	-	-	222,0	-	-	-	-	-	-	213,0
86	-	-	-	209,0	-	-	-	-	-	-	197,0
90	-	-	-	198,0	-	-	-	-	-	-	183,0
92	-	-	-	-	-	178,0	-	-	-	-	176,5
94	-	-	-	-	-	173,0	-	-	-	-	170,0
98	-	-	-	-	-	165,0	-	-	-	-	156,0
102	-	-	-	-	-	157,0	-	-	-	-	140,0
106	-	-	-	-	-	-	-	-	-	-	125,0
108	-	-	-	-	-	-	-	120,0	-	-	118,0
110	-	-	-	-	-	-	-	117,0	-	-	111,0
111	-	-	-	-	-	-	-	115,0	-	-	107,6
114	-	-	-	-	-	-	-	-	-	-	97,5
118	-	-	-	-	-	-	-	-	-	-	89,5



6 m steps of luffing jib is standard · 6 m Stufung der Wippe ist Standard · Des paliers de 6 m sont de série pour la fléchette · Falcone standard con sezioni di 6 m · Incrementos de 6 m para plumín abatible son estándar · Lances de 6 m da lança auxiliar como padrão · 6 м шаг размера гуська является стандартом

* Main boom angle 88° · Hauptauslegerwinkel 88° · Jarret de flèche principale 88° · Inclinazione braccio base 88° · Ángulo de pluma principal 88° · Angulo da lança principal 88° · Угол подъема гл. стрелы 88°

Main boom angle 88°, 85°, 75°, 65°, 55° and 45°; capacities for intermediate boom positions are calculated by the crane control system IC-1 · Hauptauslegerwinkel 88°, 85°, 75°, 65°, 55° und 45°; Traglasten für Zwischenstellungen des Hauptauslegers werden von der Kransteuerung IC-1 berechnet

Jarret de flèche principale 88°, 85°, 75°, 65°, 55° et 45°; le système de commande de la grue IC-1 calcule les charges pour les positions intermédiaires de la flèche

Inclinazione braccio base 88°, 85°, 75°, 65°, 55° e 45°; capacità per posizioni intermedie del braccio sono calcolate dal sistema di controllo della gru IC-1

Ángulo de pluma principal 88°, 85°, 75°, 65°, 55° y 45° las capacidades para posiciones de pluma intermedias son calculadas por el sistema de control de grúa IC-1

Ángulos da lança principal 88°, 85°, 75°, 65°, 55° e 45°; as capacidades para posições da lança intermediária são calculadas pelo sistema de controle da grua IC-1

Грузоподъемность при углах подъема главной стрелы 88°, 85°, 75°, 65°, 55° и 45°, грузоподъемность в промежуточных положениях стрелы рассчитывается системой управления краном IC-1

295 t + 60 t 19-30 m 10,5 m 9.8 m/s 360° ISO									72 m + 72 m									72 m + 84 m																	
SWSL				SFSL					SWSL				SFSL					SWSL				SFSL													
0 t			0 t - 640 t						0 t			0 t - 640 t						0 t			0 t - 640 t						0 t			0 t - 640 t					
88°/85°		88°/85°		75°		65°		55°		45°		88°/85°		88°/85°		75°		65°		55°		45°		88°/85°		88°/85°		75°		65°		55°		45°	
m	t	t	t	t	t	t	t	t	t	m	t	t	t	t	t	t	t	t	t	m	t	t	t	t	t	t	t	t	t	t	t	t			
30	185,0*	257,0*	-	-	-	-	-	-	-	34	150,0*	208,0*	-	-	-	-	-	-	-	38	132,0*	202,0*	-	-	-	-	-	-	-	-	-	-			
34	162,0*	249,0*	-	-	-	-	-	-	-	38	132,0*	202,0*	-	-	-	-	-	-	-	42	117,0*	216,0	-	-	-	-	-	-	-	-	-	-			
36	153,0*	266,0	-	-	-	-	-	-	260,0	42	117,0*	216,0	-	-	-	-	-	-	46	105,0*	212,0	-	-	-	-	-	-	-	-	-	-	211,0			
38	144,0*	266,0	-	-	-	-	-	-	260,0	46	105,0*	212,0	-	-	-	-	-	-	50	94,0*	208,0	-	-	-	-	-	-	-	-	-	-	211,0			
42	128,0*	261,0	-	-	-	-	-	-	260,0	50	94,0*	208,0	-	-	-	-	-	-	54	84,5*	205,0	-	-	-	-	-	-	-	-	-	-	211,0			
46	115,0*	256,0	-	-	-	-	-	-	260,0	54	84,5*	205,0	-	-	-	-	-	-	58	76,0*	201,0	-	-	-	-	-	-	-	-	-	-	211,0			
50	104,0*	250,0	-	-	-	-	-	-	260,0	58	76,0*	201,0	-	-	-	-	-	-	62	69,0*	197,0	-	-	-	-	-	-	-	-	-	-	210,0			
54	94,0*	244,0	-	-	-	-	-	-	260,0	62	69,0*	197,0	-	-	-	-	-	-	66	62,0*	193,0	216,0	-	-	-	-	-	-	-	-	-	206,0			
58	85,5*	238,0	-	-	-	-	-	-	256,0	66	62,0*	193,0	216,0	-	-	-	-	-	70	56,5*	179,0	216,0	-	-	-	-	-	-	-	-	-	202,0			
60	81,5*	235,0	272,0	-	-	-	-	-	252,5	70	56,5*	179,0	216,0	-	-	-	-	-	74	51,0*	164,0	216,0	-	-	-	-	-	-	-	-	-	198,0			
62	77,5*	224,0	272,0	-	-	-	-	-	249,0	74	51,0*	164,0	216,0	-	-	-	-	-	78	45,5*	150,0	200,0	-	-	-	-	-	-	-	-	-	194,0			
66	71,0*	204,0	269,0	-	-	-	-	-	242,0	78	45,5*	150,0	200,0	-	-	-	-	-	82	40,5*	137,5	182,0	-	-	-	-	-	-	-	-	-	188,0			
70	64,0*	186,0	251,0	-	-	-	-	-	234,0	82	40,5*	137,5	182,0	-	-	-	-	-	84	38,2*	131,0	173,0	-	-	-	-	-	-	-	-	-	185,5			
74	57,5*	166,0	227,0	-	-	-	-	-	228,0	84	38,2*	131,0	173,0	-	-	-	-	-	86	29,7	123,0	166,0	-	-	-	-	-	-	-	-	-	183,0			
78	45,6	143,0	206,0	-	-	-	-	-	221,0	86	29,7	123,0	166,0	-	-	-	-	-	88	27,8	115,0	159,0	-	-	-	-	-	-	-	-	-	181,0			
82	-	-	188,0	217,0	-	-	-	-	215,0	88	27,8	115,0	159,0	-	-	-	-	-	90	-	-	152,0	184,0	-	-	-	-	-	-	-	179,0				
86	-	-	172,0	204,0	-	-	-	-	199,0	90	-	-	152,0	184,0	-	-	-	-	94	-	-	140,0	174,0	-	-	-	-	-	-	-	169,0				
90	-	-	157,0	193,0	-	-	-	-	185,0	94	-	-	140,0	174,0	-	-	-	-	98	-	-	129,0	165,0	-	-	-	-	-	-	-	157,0				
94	-	-	-	183,0	-	-	-	-	172,0	98	-	-	129,0	165,0	-	-	-	-	102	-	-	118,0	152,0	-	-	-	-	-	-	-	146,0				
98	-	-	-	172,0	-	-	-	-	160,0	102	-	-	118,0	152,0	-	-	-	-	106	-	-	-	140,0	-	-	-	-	-	-	-	136,0				
102	-	-	-	158,0	151,0	-	-	-	149,0	106	-	-	-	140,0	-	-	-	-	110	-	-	-	129,0	-	-	-	-	-	-	-	127,0				
106	-	-	-	-	144,0	-	-	-	137,0	110	-	-	-	129,0	-	-	-	-	112	-	-	-	124,0	123,0	-	-	-	-	-	-	121,0				
110	-	-	-	-	137,0	-	-	-	123,0	112	-	-	-	124,0	123,0	-	-	-	114	-	-	-	119,0	120,0	-	-	-	-	-	-	115,0				
112	-	-	-	-	133,0	-	-	-	116,5	114	-	-	-	119,0	120,0	-	-	-	118	-	-	-	-	114,0	-	-	-	-	-	-	-	103,0			
114	-	-	-	-	-	-	-	-	110,0	118	-	-	-	-	114,0	-	-	-	122	-	-	-	-	108,0	-	-	-	-	-	-	-	92,5			
118	-	-	-	-	-	-	-	-	99,5	122	-	-	-	-	108,0	-	-	-	124	-	-	-	-	105,0	-	-	-	-	-	-	-	87,2			
122	-	-	-	-	-	-	-	-	94,5	124	-	-	-	-	105,0	-	-	-	126	-	-	-	-	-	-	-	-	-	-	-	-	82,0			
126	-	-	-	-	-	-	-	-	77,5	126	-	-	-	-	-	-	-	-	130	-	-	-	-	-	-	-	-	-	-	-	-	75,0			
130	-	-	-	-	-	-	-	-	71,0	130	-	-	-	-	-	-	-	-	134	-	-	-	-	-	-	-	-	-	-	-	-	71,0			
										134	-	-	-	-	-	-	-	-	138	-	-	-	-	-	-	-	-	-	-	-	-	57,5			
										138	-	-	-	-	-	-	-	-	142	-	-	-	-	-	-	-	-	-	-	-	-	49,6			



6 m steps of luffing jib is standard · 6 m Stufung der Wippe ist Standard · Des paliers de 6 m sont de série pour la fléchette · Falcone standard con sezioni di 6 m · Incrementos de 6 m para plumín abatible son estándar · Lances de 6 m da lança auxiliar como padrão · 6 м шаг размера гуська является стандартом

* Main boom angle 88° · Hauptauslegerwinkel 88° · Jarret de flèche principale 88° · Inclinazione braccio base 88° · Ángulo de pluma principal 88° · Ángulo da lança principal 88° · Угол подъема гл. стрелы 88°

Main boom angle 88°, 85°, 75°, 65°, 55° and 45°; capacities for intermediate boom positions are calculated by the crane control system IC-1 · Hauptauslegerwinkel 88°, 85°, 75°, 65°, 55° und 45°; Traglasten für Zwischenstellungen des Hauptauslegers werden von der Kransteuerung IC-1 berechnet

Jarret de flèche principale 88°, 85°, 75°, 65°, 55° et 45°; le système de commande de la grue IC-1 calcule les charges pour les positions intermédiaires de la flèche

Inclinazione braccio base 88°, 85°, 75°, 65°, 55° e 45°; capacità per posizioni intermedie del braccio sono calcolate dal sistema di controllo della gru IC-1

Ángulo de pluma principal 88°, 85°, 75°, 65°, 55° y 45° las capacidades para posiciones de pluma intermedias son calculadas por el sistema de control de grúa IC-1

Ángulos da lança principal 88°, 85°, 75°, 65°, 55° e 45°; as capacidades para posições da lança intermediária são calculadas pelo sistema de controle da grua IC-1

Грузоподъемность при углах подъема главной стрелы 88°, 85°, 75°, 65°, 55° и 45°, грузоподъемность в промежуточных положениях стрелы рассчитывается системой управления краном IC-1

295 t + 60 t								19-30 m								10,5 m								9.8 m/s								360°								ISO																																																							
72 m + 96 m								SWSL								SFSL								72 m + 108 m								SWSL								SFSL																																																							
0 t								0 t - 640 t								0 t								0 t - 640 t								0 t								0 t - 640 t																																																							
88°/85°								88°/85°								75°								65°								55°								45°								88°/85°								88°/85°								75°								65°								55°								45°							
m								t								t								t								t								t								t								t								t																															
36	131,0*	167,0*	-	-	-	-	-	40	107,0*	133,0*	-	-	-	-	-	-	50	79,0*	134,0*	-	-	-	-	-	-	133,0																																																																					
38	123,0*	167,0*	-	-	-	-	-	42	101,0*	132,0*	-	-	-	-	-	-	54	70,0*	132,0*	-	-	-	-	-	-	133,0																																																																					
42	109,0*	164,0*	-	-	-	-	-	46	89,0*	130,0*	-	-	-	-	-	-	58	62,5*	131,0	-	-	-	-	-	-	133,0																																																																					
46	97,0*	173,0	-	-	-	-	-	50	79,0*	134,0*	-	-	-	-	-	-	62	55,5*	129,0	-	-	-	-	-	-	132,0																																																																					
50	86,5*	170,0	-	-	-	-	-	54	70,0*	132,0*	-	-	-	-	-	-	66	49,3*	127,0	-	-	-	-	-	-	131,0																																																																					
54	77,0*	168,0	-	-	-	-	-	58	62,5*	131,0	-	-	-	-	-	-	70	43,7*	125,0	-	-	-	-	-	-	129,0																																																																					
58	69,0*	166,0	-	-	-	-	-	62	55,5*	129,0	-	-	-	-	-	-	74	38,6*	123,0	-	-	-	-	-	-	128,0																																																																					
62	62,0*	163,0	-	-	-	-	-	66	49,3*	127,0	-	-	-	-	-	-	78	34,0*	121,0	124,0	-	-	-	-	-	125,0																																																																					
66	55,5*	161,0	-	-	-	-	-	70	43,7*	125,0	-	-	-	-	-	-	82	29,9*	119,0	124,0	-	-	-	-	-	123,0																																																																					
70	50,0*	158,0	-	-	-	-	-	74	38,6*	123,0	-	-	-	-	-	-	86	26,0*	116,5	124,0	-	-	-	-	-	121,0																																																																					
72	47,3*	157,0	168,0	-	-	-	-	78	40,1*	148,0	168,0	-	-	-	-	-	90	22,5*	110,5	124,0	-	-	-	-	-	119,0																																																																					
74	44,8*	156,0	168,0	-	-	-	-	82	35,8*	136,0	168,0	-	-	-	-	-	94	19,2*	102,0	124,0	-	-	-	-	-	117,0																																																																					
78	40,1*	148,0	168,0	-	-	-	-	86	31,9*	125,0	164,0	-	-	-	-	-	96	17,7*	98,0	124,0	-	-	-	-	-	116,0																																																																					
82	35,8*	136,0	168,0	-	-	-	-	90	28,3*	115,5	150,0	-	-	-	-	-	98	16,2*	94,2	122,0	-	-	-	-	-	115,0																																																																					
86	31,9*	125,0	164,0	-	-	-	-	94	24,9*	105,5	138,0	-	-	-	-	-	102	13,4*	87,0	112,0	-	-	-	-	-	113,0																																																																					
90	28,3*	115,5	150,0	-	-	-	-	96	23,2*	100,0	132,0	-	-	-	-	-	104	12,1*	83,5	107,0	-	-	-	-	-	111,5																																																																					
94	24,9*	105,5	138,0	-	-	-	-	98	15,8	94,0	127,0	150,0	-	-	-	-	106	-	79,0	103,0	109,0	-	-	-	-	110,0																																																																					
96	23,2*	100,0	132,0	-	-	-	-	100	14,4	88,0	121,0	150,0	-	-	-	-	108	-	74,5	99,0	109,0	-	-	-	-	109,0																																																																					
98	15,8	94,0	127,0	150,0	-	-	-	102	-	-	117,0	150,0	-	-	-	-	110	-	69,5	95,0	109,0	-	-	-	-	108,0																																																																					
100	14,4	88,0	121,0	150,0	-	-	-	106	-	-	108,0	137,0	-	-	-	-	112	-	64,5	91,5	109,0	-	-	-	-	107,0																																																																					
102	-	-	117,0	150,0	-	-	-	108	-	-	117,0	150,0	-	-	-	-	114	-	-	88,0	109,0	-	-	-	-	106,0																																																																					
106	-	-	108,0	137,0	-	-	-	110	-	-	117,0	150,0	-	-	-	-	118	-	-	81,0	103,0	-	-	-	-	104,0																																																																					
110	-	-	100,0	126,0	-	-	-	112	-	-	108,0	137,0	-	-	-	-	122	-	-	75,0	95,0	-	-	-	-	101,0																																																																					
112	-	-	96,0	121,0	-	-	-	114	-	-	104,0	106,0	-	-	-	-	124	-	-	72,0	91,5	-	-	-	-	97,0																																																																					
114	-	-	-	117,0	-	-	-	118	-	-	100,0	103,0	-	-	-	-	126	-	-	-	88,0	-	-	-	-	93,0																																																																					
118	-	-	-	108,0	-	-	-	120	-	-	96,0	100,0	-	-	-	-	130	-	-	-	81,0	85,5	-	-	-	83,5																																																																					
120	-	-	-	104,0	106,0	-	-	122	-	-	100,0	103,0	-	-	-	-	134	-	-	-	75,0	80,5	-	-	-	75,0																																																																					
122	-	-	-	100,0	103,0	-	-	124	-	-	96,0	100,0	-	-	-	-	136	-	-	-	72,5	78,5	-	-	-	70,5																																																																					
124	-	-	-	96,0	100,0	-	-	126	-	-	-	97,5	-	-	-	-	138	-	-	-	-	76,0	-	-	-	66,0																																																																					
126	-	-	-	-	97,5	-	-	128	-	-	-	97,5	-	-	-	-	142	-	-	-	-	72,0	-	-	-	58,0																																																																					
130	-	-	-	-	92,5	-	-	130	-	-	-	92,5	-	-	-	-	146	-	-	-	-	68,5	-	-	-	50,0																																																																					
134	-	-	-	-	87,5	-	-	132	-	-	-	87,5	-	-	-	-	148	-	-	-	-	66,5	-	-	-	46,2																																																																					
136	-	-	-	-	85,5	-	-	134	-	-	-	85,5	-	-	-	-	150	-	-	-	-	-	-	-	-	44,4																																																																					
138	-	-	-	-	-	-	-	136	-	-	-	80,0	-	-	-	-	154	-	-	-	-	-	-	-	-	41,7																																																																					
140	-	-	-	-	-	-	-	138	-	-	-	80,0	-	-	-	-	156	-	-	-	-	-	-	-	-	40,8																																																																					
142	-	-	-	-	-	-	-	140	-	-	-	59,5	57,0	-	-	-	158	-	-	-	-	-	-	-	-	33,5																																																																					
146	-	-	-	-	-	-	-	142	-	-	-	58,0	52,5	-	-	-	162	-	-	-	-	-	-	-	-	26,2																																																																					
148	-	-	-	-	-	-	-	144	-	-	-	54,5	47,9	-	-	-	166	-	-	-	-	-	-	-	-	18,9																																																																					
150	-	-	-	-	-	-	-	146	-	-	-	54,5	47,9	-	-	-	-	-	-	-	-	-	-	-	-	-																																																																					
154	-	-	-	-	-	-	-	150	-	-	-	42,3	42,3	-	-	-	-	-	-	-	-	-	-	-	-	-																																																																					
154	-	-	-	-	-	-	-	154	-	-	-	33,9	33,9	-	-	-	-	-	-	-	-	-	-	-	-	-																																																																					

0 t 100 t 180 t 240 t 340 t 440 t 540 t 640 t

6 m steps of luffing jib is standard · 6 m Stufung der Wippe ist Standard · Des paliers de 6 m sont de série pour la fléchette · Falcone standard con sezioni di 6 m · Incrementos de 6 m para plumín abatible son estándar · Lances de 6 m da lança auxiliar como padrão · 6 м шаг размера гуська является стандартом

* Main boom angle 88° · Hauptauslegerwinkel 88° · Jarret de flèche principale 88° · Inclinazione braccio base 88° · Ângulo de pluma principal 88° · Ângulo da lança principal 88° · Угол подъема гл. стрелы 88°

Main boom angle 88°, 85°, 75°, 65°, 55° and 45°; capacities for intermediate boom positions are calculated by the crane control system IC-1
Hauptauslegerwinkel 88°, 85°, 75°, 65°, 55° und 45°; Traglasten für Zwischenstellungen des Hauptauslegers werden von der Kransteuerung IC-1 berechnet

Jarret de flèche principale 88°, 85°, 75°, 65°, 55° et 45°; le système de commande de la grue IC-1 calcule les charges pour les positions intermédiaires de la flèche

Inclinazione braccio base 88°, 85°, 75°, 65°, 55° e 45°; capacità per posizioni intermedie del braccio sono calcolate dal sistema di controllo della gru IC-1

Ângulo de pluma principal 88°, 85°, 75°, 65°, 55° y 45° las capacidades para posiciones de pluma intermedias son calculadas por el sistema de control de grúa IC-1

Ângulos da lança principal 88°, 85°, 75°, 65°, 55° e 45°; as capacidades para posições da lança intermediária são calculadas pelo sistema de controle da grua IC-1

Грузоподъемность при углах подъема главной стрелы 88°, 85°, 75°, 65°, 55° и 45°, грузоподъемность в промежуточных положениях стрелы рассчитывается системой управления краном IC-1

295 t + 60 t								19-30 m								10,5 m								9.8 m/s								360°								ISO							
78 m + 36 m								SWSL								SFSL								78 m + 48 m								SWSL								SFSL							
0 t								0 t - 640 t								0 t								0 t - 640 t								0 t								0 t - 640 t							
88°/85°								88°/85°								75°								65°								55°								45°							
m	t	t	t	t	t	t	t	m	t	t	t	t	t	t	t	m	t	t	t	t	t	t	t	m	t	t	t	t	t	t	t	m	t	t	t	t	t	t	t								
20	318,0*	449,0*	-	-	-	-	-	22	273,0*	362,0*	-	-	-	-	-	24	252,0*	358,0*	-	-	-	-	-	-	-	-	26	233,0*	349,0*	-	-	-	-	-													
22	291,0*	436,0*	-	-	-	-	-	24	252,0*	358,0*	-	-	-	-	-	26	233,0*	349,0*	-	-	-	-	-	-	-	-	28	217,0*	340,0*	-	-	-	-	-													
24	269,0*	422,0*	-	-	-	-	-	26	233,0*	349,0*	-	-	-	-	-	28	217,0*	340,0*	-	-	-	-	-	-	-	-	30	203,0*	377,0	-	-	-	-	-													
26	249,0*	469,0	-	-	-	-	460,0	28	217,0*	340,0*	-	-	-	-	-	30	203,0*	377,0	-	-	-	-	-	-	-	32	184,0*	364,0	-	-	-	-	-														
28	231,0*	459,0	-	-	-	-	460,0	30	203,0*	377,0	-	-	-	-	-	32	184,0*	364,0	-	-	-	-	-	-	-	34	178,0*	364,0	-	-	-	-	-														
30	216,0*	449,0	-	-	-	-	460,0	32	184,0*	364,0	-	-	-	-	-	34	178,0*	364,0	-	-	-	-	-	-	-	36	158,0*	351,0	-	-	-	-	-														
32	190,0*	429,0	-	-	-	-	460,0	34	178,0*	364,0	-	-	-	-	-	36	158,0*	351,0	-	-	-	-	-	-	-	38	158,0*	351,0	-	-	-	-	-														
34	190,0*	429,0	-	-	-	-	460,0	36	158,0*	351,0	-	-	-	-	-	38	158,0*	351,0	-	-	-	-	-	-	-	40	159,0*	380,0	-	-	-	-	-														
36	170,0*	410,0	-	-	-	-	460,0	38	158,0*	351,0	-	-	-	-	-	40	159,0*	380,0	-	-	-	-	-	-	-	42	138,0	353,0	-	-	-	-	-														
38	170,0*	410,0	-	-	-	-	460,0	40	159,0*	380,0	-	-	-	-	-	42	138,0	353,0	-	-	-	-	-	-	-	44	129,0	329,0	463,0	-	-	-	-														
40	159,0*	380,0	-	-	-	-	460,0	42	138,0	353,0	-	-	-	-	-	44	129,0	329,0	463,0	-	-	-	-	-	-	46	-	-	463,0	-	-	-	-														
42	138,0	353,0	-	-	-	-	451,0	44	129,0	329,0	463,0	-	-	-	-	46	-	-	463,0	-	-	-	-	-	-	48	-	-	463,0	-	-	-	-														
44	129,0	329,0	463,0	-	-	-	439,0	46	-	-	463,0	-	-	-	48	-	-	463,0	-	-	-	-	-	-	50	-	-	427,0	-	-	-	-															
46	-	-	463,0	-	-	-	427,0	48	-	-	427,0	-	-	-	50	-	-	427,0	-	-	-	-	-	-	52	-	-	408,0	-	-	-	-															
50	-	-	427,0	-	-	-	408,0	50	-	-	408,0	-	-	-	52	-	-	408,0	-	-	-	-	-	-	54	-	-	372,0	-	-	-	-															
54	-	-	373,0	-	-	-	372,0	54	-	-	373,0	-	-	-	54	-	-	373,0	-	-	-	-	-	-	56	-	-	337,0	-	-	-	-															
58	-	-	323,0	-	-	-	337,0	58	-	-	323,0	-	-	-	58	-	-	323,0	-	-	-	-	-	-	58	-	-	316,0	-	-	-	-															
61	-	-	-	-	-	-	314,5	61	-	-	-	-	-	-	61	-	-	316,0	-	-	-	-	-	-	62	-	-	311,0	-	-	-	-															
62	-	-	-	-	-	-	307,0	62	-	-	-	-	-	-	62	-	-	311,0	-	-	-	-	-	-	66	-	-	289,0	-	-	-	-															
66	-	-	-	-	-	-	280,0	66	-	-	-	-	-	-	66	-	-	289,0	-	-	-	-	-	-	70	-	-	270,0	-	-	-	-															
70	-	-	-	-	-	-	257,0	70	-	-	-	-	-	-	70	-	-	270,0	-	-	-	-	-	-	74	-	-	266,0	-	-	-	-															
71	-	-	-	-	-	-	251,7	71	-	-	-	-	-	-	71	-	-	266,0	-	-	-	-	-	-	74	-	-	-	-	-	-	-															
74	-	-	-	-	-	-	236,0	74	-	-	-	-	-	-	74	-	-	-	-	-	-	-	-	-	77	-	-	-	-	-	-	-															
77	-	-	-	-	-	-	222,5	77	-	-	-	-	-	-	77	-	-	-	-	-	-	-	-	-	78	-	-	224,0	-	-	-	-															
78	-	-	-	-	-	-	218,0	78	-	-	-	-	-	-	78	-	-	224,0	-	-	-	-	-	-	82	-	-	220,0	-	-	-	-															
82	-	-	-	-	-	-	201,0	82	-	-	-	-	-	-	82	-	-	220,0	-	-	-	-	-	-	86	-	-	208,0	-	-	-	-															
86	-	-	-	-	-	-	184,0	86	-	-	-	-	-	-	86	-	-	208,0	-	-	-	-	-	-	90	-	-	-	-	-	-	-															
90	-	-	-	-	-	-	164,0	90	-	-	-	-	-	-	90	-	-	-	-	-	-	-	-	-	94	-	-	-	-	-	-	-															
91	-	-	-	-	-	-	159,2	91	-	-	-	-	-	-	91	-	-	-	-	-	-	-	-	-	94	-	-	-	-	-	-	-															
93	-	-	-	-	-	-	149,7	93	-	-	-	-	-	-	93	-	-	-	-	-	-	-	-	-	98	-	-	-	-	-	-	-															
94	-	-	-	-	-	-	145,0	94	-	-	-	-	-	-	94	-	-	-	-	-	-	-	-	-	98	-	-	-	-	-	-	-															
98	-	-	-	-	-	-	127,0	98	-	-	-	-	-	-	98	-	-	-	-	-	-	-	-	-	102	-	-	-	-	-	-	-															
102	-	-	-	-	-	-	112,0	102	-	-	-	-	-	-	102	-	-	-	-	-	-	-	-	-	104	-	-	-	-	-	-	-															
								104	-	-	-	-	-	-	104	-	-	-	-	-	-	-	-	-	106	-	-	-	-	-	-	-															
								106	-	-	-	-	-	-	106	-	-	-	-	-	-	-	-	-	110	-	-	-	-	-	-	-															
								110	-	-	-	-	-	-	110	-	-	-	-	-	-	-	-	-	114	-	-	-	-	-	-	-															
								114	-	-	-	-	-	-	114	-	-	-	-	-	-	-	-	-																							

0 t 100 t 180 t 240 t 340 t 440 t 540 t 640 t

6 m steps of luffing jib is standard · 6 m Stufung der Wippe ist Standard · Des paliers de 6 m sont de série pour la fléchette · Falcone standard con sezioni di 6 m · Incrementos de 6 m para plumín abatible son estándar · Lances de 6 m da lança auxiliar como padrão · 6 м шаг размера гуська является стандартом

* Main boom angle 88° · Hauptauslegerwinkel 88° · Jarret de flèche principale 88° · Inclinazione braccio base 88° · Ângulo de pluma principal 88° · Ângulo da lança principal 88° · Угол подъема гл. стрелы 88°

Main boom angle 88°, 85°, 75°, 65°, 55° and 45°; capacities for intermediate boom positions are calculated by the crane control system IC-1 · Hauptauslegerwinkel 88°, 85°, 75°, 65°, 55° und 45°; Traglasten für Zwischenstellungen des Hauptauslegers werden von der Kransteuerung IC-1 berechnet

Jarret de flèche principale 88°, 85°, 75°, 65°, 55° et 45°; le système de commande de la grue IC-1 calcule les charges pour les positions intermédiaires de la flèche

Inclinazione braccio base 88°, 85°, 75°, 65°, 55° e 45°; capacità per posizioni intermedie del braccio sono calcolate dal sistema di controllo della gru IC-1

Ângulo de pluma principal 88°, 85°, 75°, 65°, 55° y 45° las capacidades para posiciones de pluma intermedias son calculadas por el sistema de control de grúa IC-1

Ângulos da lança principal 88°, 85°, 75°, 65°, 55° e 45°; as capacidades para posições da lança intermediária são calculadas pelo sistema de controle da grua IC-1

Грузоподъемность при углах подъема главной стрелы 88°, 85°, 75°, 65°, 55° и 45°, грузоподъемность в промежуточных положениях стрелы рассчитывается системой управления краном IC-1

295 t + 60 t								19-30 m								10,5 m								9.8 m/s								360°								ISO																																																							
78 m + 60 m								SWSL								SFSL								78 m + 72 m								SWSL								SFSL																																																							
0 t								0 t - 640 t								0 t								0 t - 640 t								0 t								0 t - 640 t																																																							
88°/85°								88°/85°								75°								65°								55°								45°								88°/85°								88°/85°								75°								65°								55°								45°							
m								t								t								t								t								t								t								t								t																															
26	220,0*	293,0*	-	-	-	-	-	30	179,0*	240,0*	-	-	-	-	-	-	34	157,0*	233,0*	-	-	-	-	-	-	-	-	-	-																																																																		
28	205,0*	290,0*	-	-	-	-	-	34	157,0*	233,0*	-	-	-	-	-	-	38	139,0*	250,0*	-	-	-	-	-	-	-	-	-	-																																																																		
30	191,0*	285,0*	-	-	-	-	-	38	139,0*	250,0*	-	-	-	-	-	-	42	124,0*	244,0*	-	-	-	-	-	-	-	-	-	243,0																																																																		
34	168,0*	307,0*	-	-	-	-	-	42	124,0*	244,0*	-	-	-	-	-	-	46	111,0*	239,0*	-	-	-	-	-	-	-	-	-	243,0																																																																		
38	149,0*	298,0*	-	-	-	-	-	46	111,0*	239,0*	-	-	-	-	-	-	50	100,0*	233,0*	-	-	-	-	-	-	-	-	-	243,0																																																																		
42	133,0*	290,0*	-	-	-	-	-	50	100,0*	233,0*	-	-	-	-	-	-	54	91,0*	228,0*	-	-	-	-	-	-	-	-	-	243,0																																																																		
46	120,0*	282,0*	-	-	-	-	-	54	91,0*	228,0*	-	-	-	-	-	-	58	82,5*	222,0*	-	-	-	-	-	-	-	-	-	241,0																																																																		
50	108,0*	273,0*	-	-	-	-	-	58	82,5*	222,0*	-	-	-	-	-	-	62	75,0*	217,0*	254,0	-	-	-	-	-	-	-	-	235,0																																																																		
54	98,5*	265,0*	-	-	-	-	-	62	75,0*	217,0*	254,0	-	-	-	-	-	66	68,5*	207,0*	254,0	-	-	-	-	-	-	-	-	230,0																																																																		
56	94,0*	259,0*	314,0	-	-	-	-	66	68,5*	207,0*	254,0	-	-	-	-	-	70	63,0*	189,0*	250,0	-	-	-	-	-	-	-	-	224,0																																																																		
58	90,0*	246,0*	313,0	-	-	-	-	70	63,0*	189,0*	250,0	-	-	-	-	-	74	57,0*	166,0*	236,0	-	-	-	-	-	-	-	-	216,0																																																																		
62	81,0*	222,0*	307,0	-	-	-	-	74	57,0*	166,0*	236,0	-	-	-	-	-	78	44,1	143,0	214,0	-	-	-	-	-	-	-	-	211,0																																																																		
66	65,5	195,0	285,0	-	-	-	-	78	44,1	143,0	214,0	-	-	-	-	-	82	-	-	196,0	-	-	-	-	-	-	-	205,0																																																																			
70	-	-	255,0	-	-	-	-	82	-	-	196,0	-	-	-	-	-	86	-	-	179,0	198,0	-	-	-	-	-	-	195,0																																																																			
74	-	-	231,0	-	-	-	-	86	-	-	179,0	198,0	-	-	-	-	90	-	-	163,0	187,0	-	-	-	-	-	-	181,0																																																																			
77	-	-	215,0	233,0	-	-	-	90	-	-	163,0	187,0	-	-	-	-	92	-	-	152,0	182,0	-	-	-	-	-	-	174,5																																																																			
78	-	-	210,0	229,0	-	-	-	92	-	-	152,0	182,0	-	-	-	-	94	-	-	-	177,0	-	-	-	-	-	-	168,0																																																																			
80	-	-	200,0	222,0	-	-	-	94	-	-	-	177,0	-	-	-	-	98	-	-	-	168,0	-	-	-	-	-	-	156,0																																																																			
82	-	-	-	216,0	-	-	-	98	-	-	-	168,0	-	-	-	-	102	-	-	-	160,0	-	-	-	-	-	-	145,0																																																																			
86	-	-	-	204,0	-	-	-	102	-	-	-	160,0	-	-	-	-	104	-	-	-	156,0	-	-	-	-	-	-	140,0																																																																			
90	-	-	-	193,0	-	-	-	104	-	-	-	156,0	-	-	-	-	106	-	-	-	-	137,0	-	-	-	-	-	135,0																																																																			
94	-	-	-	183,0	-	-	-	106	-	-	-	-	137,0	-	-	-	110	-	-	-	-	130,0	-	-	-	-	-	125,0																																																																			
96	-	-	-	-	162,0	-	-	110	-	-	-	-	130,0	-	-	-	114	-	-	-	-	124,0	-	-	-	-	-	114,0																																																																			
98	-	-	-	-	158,0	-	-	114	-	-	-	-	124,0	-	-	-	116	-	-	-	-	122,0	-	-	-	-	-	108,0																																																																			
102	-	-	-	-	150,0	-	-	116	-	-	-	-	122,0	-	-	-	118	-	-	-	-	-	-	-	-	-	-	102,0																																																																			
104	-	-	-	-	146,0	-	-	118	-	-	-	-	-	-	-	-	122	-	-	-	-	-	-	-	91,5	-	-	90,5																																																																			
106	-	-	-	-	-	-	-	122	-	-	-	-	-	-	-	-	126	-	-	-	-	-	-	86,5	-	-	-	79,5																																																																			
110	-	-	-	-	-	-	-	126	-	-	-	-	-	-	-	-	130	-	-	-	-	-	-	-	-	-	-	68,5																																																																			
112	-	-	-	-	-	-	-	130	-	-	-	-	-	-	-	-	134	-	-	-	-	-	-	-	-	-	-	61,5																																																																			
114	-	-	-	-	-	-	-	134	-	-	-	-	-	-	-	-	-	-	-	-	-	-	-	-	-	-	-	-																																																																			
116	-	-	-	-	-	-	-	-	-	-	-	-	-	-	-	-	-	-	-	-	-	-	-	-	-	-	-	-																																																																			
118	-	-	-	-	-	-	-	-	-	-	-	-	-	-	-	-	-	-	-	-	-	-	-	-	-	-	-	-																																																																			
122	-	-	-	-	-	-	-	-	-	-	-	-	-	-	-	-	-	-	-	-	-	-	-	-	-	-	-	-																																																																			
126	-	-	-	-	-	-	-	-	-	-	-	-	-	-	-	-	-	-	-	-	-	-	-	-	-	-	-	-																																																																			

6 m steps of luffing jib is standard · 6 m Stufung der Wippe ist Standard · Des paliers de 6 m sont de série pour la fléchette · Falcone standard con sezioni di 6 m · Incrementos de 6 m para plumín abatible son estándar · Lancas de 6 m da lança auxiliar como padrão · 6 м шаг размера гуська является стандартом

* Main boom angle 88° · Hauptauslegerwinkel 88° · Jarret de flèche principale 88° · Inclinazione braccio base 88° · Ângulo de pluma principal 88° · Ângulo da lança principal 88° · Угол подъема гл. стрелы 88°

Main boom angle 88°, 85°, 75°, 65°, 55° and 45°; capacities for intermediate boom positions are calculated by the crane control system IC-1 · Hauptauslegerwinkel 88°, 85°, 75°, 65°, 55° und 45°; Traglasten für Zwischenstellungen des Hauptauslegers werden von der Kransteuerung IC-1 berechnet

Jarret de flèche principale 88°, 85°, 75°, 65°, 55° et 45°; le système de commande de la grue IC-1 calcule les charges pour les positions intermédiaires de la flèche

Inclinazione braccio base 88°, 85°, 75°, 65°, 55° e 45°; capacità per posizioni intermedie del braccio sono calcolate dal sistema di controllo della gru IC-1

Ângulo de pluma principal 88°, 85°, 75°, 65°, 55° y 45° las capacidades para posiciones de pluma intermedias son calculadas por el sistema de control de grúa IC-1

Ângulos da lança principal 88°, 85°, 75°, 65°, 55° e 45°; as capacidades para posições da lança intermediária são calculadas pelo sistema de controle da grua IC-1

Грузоподъемность при углах подъема главной стрелы 88°, 85°, 75°, 65°, 55° и 45°, грузоподъемность в промежуточных положениях стрелы рассчитывается системой управления краном IC-1

295 t + 60 t								19-30 m								10,5 m								9.8 m/s								360°								ISO							
78 m + 84 m								SWSL								SFSL								78 m + 96 m								SWSL								SFSL							
0 t								0 t - 640 t								0 t								0 t - 640 t								0 t								0 t - 640 t							
88°/85°								88°/85°								75°								65°								55°								45°							
m	t	t	t	t	t	t	t	m	t	t	t	t	t	t	t	m	t	t	t	t	t	t	t	m	t	t	t	t	t	t	t	m	t	t	t	t	t	t	t								
34	145,0*	195,0*	-	-	-	-	-	36	127,0*	157,0*	-	-	-	-	-	38	119,0*	157,0*	-	-	-	-	-	-	-	-	42	105,0*	153,0*	-	-	-	-	-													
38	128,0*	190,0*	-	-	-	-	-	38	119,0*	157,0*	-	-	-	-	-	42	105,0*	153,0*	-	-	-	-	-	-	-	-	46	93,5*	162,0*	-	-	-	-	159,0													
42	114,0*	202,0	-	-	-	-	198,0	46	93,5*	162,0*	-	-	-	-	-	46	93,5*	162,0*	-	-	-	-	-	-	-	50	83,5*	160,0	-	-	-	-	159,0														
46	101,0*	199,0	-	-	-	-	198,0	50	83,5*	160,0	-	-	-	-	-	50	83,5*	160,0	-	-	-	-	-	-	-	54	74,5*	158,0	-	-	-	-	159,0														
50	91,0*	195,0	-	-	-	-	198,0	54	74,5*	158,0	-	-	-	-	-	54	74,5*	158,0	-	-	-	-	-	-	-	58	66,5*	156,0	-	-	-	-	159,0														
54	81,5*	192,0	-	-	-	-	198,0	58	66,5*	156,0	-	-	-	-	-	58	66,5*	156,0	-	-	-	-	-	-	-	62	59,5*	153,0	-	-	-	-	159,0														
58	73,5*	188,0	-	-	-	-	198,0	62	59,5*	153,0	-	-	-	-	-	62	59,5*	153,0	-	-	-	-	-	-	-	66	53,5*	151,0	-	-	-	-	159,0														
62	66,5*	184,0	-	-	-	-	197,0	66	53,5*	151,0	-	-	-	-	-	66	53,5*	151,0	-	-	-	-	-	-	-	70	47,8*	148,0	-	-	-	-	158,0														
66	60,0*	180,0	-	-	-	-	194,0	70	47,8*	148,0	-	-	-	-	-	70	47,8*	148,0	-	-	-	-	-	-	-	74	42,8*	146,0	158,0	-	-	-	155,0														
68	57,0*	179,0	202,0	-	-	-	192,0	74	42,8*	146,0	158,0	-	-	-	-	74	42,8*	146,0	158,0	-	-	-	-	-	-	78	38,2*	143,0	158,0	-	-	-	153,0														
70	54,0*	177,0	202,0	-	-	-	190,0	78	38,2*	143,0	158,0	-	-	-	-	78	38,2*	143,0	158,0	-	-	-	-	-	-	82	34,0*	138,0	158,0	-	-	-	151,0														
74	49,1*	168,0	202,0	-	-	-	187,0	82	34,0*	138,0	158,0	-	-	-	-	82	34,0*	138,0	158,0	-	-	-	-	-	-	86	30,2*	129,5	158,0	-	-	-	149,5														
78	44,5*	154,0	202,0	-	-	-	183,0	86	30,2*	129,5	158,0	-	-	-	-	86	30,2*	129,5	158,0	-	-	-	-	-	-	90	26,7*	118,5	158,0	-	-	-	148,0														
82	39,9*	139,5	190,0	-	-	-	178,0	90	26,7*	118,5	158,0	-	-	-	-	90	26,7*	118,5	158,0	-	-	-	-	-	-	94	23,4*	106,5	145,0	-	-	-	146,0														
84	37,6*	131,0	182,0	-	-	-	176,0	94	23,4*	106,5	145,0	-	-	-	-	94	23,4*	106,5	145,0	-	-	-	-	-	-	96	21,9*	100,0	139,0	-	-	-	142,0														
86	28,3	123,0	174,0	-	-	-	174,0	96	21,9*	100,0	139,0	-	-	-	-	96	21,9*	100,0	139,0	-	-	-	-	-	-	98	13,9	93,7	134,0	-	-	-	139,0														
88	26,4	115,0	166,0	-	-	-	172,0	98	13,9	93,7	134,0	-	-	-	-	98	13,9	93,7	134,0	-	-	-	-	-	-	100	12,6	87,5	128,0	141,0	-	-	138,0														
90	-	-	159,0	-	-	-	170,0	100	12,6	87,5	128,0	141,0	-	-	-	100	12,6	87,5	128,0	141,0	-	-	-	-	-	102	-	-	123,0	141,0	-	-	137,0														
92	-	-	153,0	173,0	-	-	167,5	102	-	-	123,0	141,0	-	-	-	102	-	-	123,0	141,0	-	-	-	-	-	106	-	-	114,0	139,0	-	-	133,0														
94	-	-	147,0	168,0	-	-	165,0	106	-	-	114,0	139,0	-	-	-	106	-	-	114,0	139,0	-	-	-	-	-	110	-	-	106,0	131,0	-	-	123,0														
98	-	-	135,0	159,0	-	-	153,0	110	-	-	106,0	131,0	-	-	-	110	-	-	106,0	131,0	-	-	-	-	-	114	-	-	94,5	125,0	-	-	115,0														
102	-	-	122,0	151,0	-	-	142,0	114	-	-	94,5	125,0	-	-	-	114	-	-	94,5	125,0	-	-	-	-	-	118	-	-	-	116,0	-	-	106,0														
104	-	-	114,0	147,0	-	-	137,0	118	-	-	-	116,0	-	-	-	118	-	-	-	116,0	-	-	-	-	-	122	-	-	-	108,0	-	-	99,0														
106	-	-	-	143,0	-	-	132,0	122	-	-	-	108,0	-	-	-	122	-	-	-	108,0	-	-	-	-	-	124	-	-	-	104,0	97,0	-	95,0														
110	-	-	-	136,0	-	-	123,0	124	-	-	-	104,0	97,0	-	-	124	-	-	-	104,0	97,0	-	-	-	-	126	-	-	-	100,0	94,5	-	91,0														
114	-	-	-	128,0	115,0	-	114,0	126	-	-	-	100,0	94,5	-	-	126	-	-	-	100,0	94,5	-	-	-	-	128	-	-	-	96,5	92,0	-	86,2														
116	-	-	-	123,0	112,0	-	109,5	130	-	-	-	96,5	92,0	-	-	130	-	-	-	96,5	92,0	-	-	-	-	134	-	-	-	85,5	-	-	81,5														
118	-	-	-	-	110,0	-	105,0	134	-	-	-	92,0	90,0	-	-	134	-	-	-	92,0	90,0	-	-	-	-	138	-	-	-	81,0	-	-	72,5														
122	-	-	-	-	104,0	-	95,0	140	-	-	-	90,0	85,5	-	-	140	-	-	-	90,0	85,5	-	-	-	-	142	-	-	-	79,0	-	-	63,5														
126	-	-	-	-	100,0	-	84,5	142	-	-	-	85,5	81,0	-	-	142	-	-	-	85,5	81,0	-	-	-	-	146	-	-	-	79,0	-	-	59,2														
128	-	-	-	-	98,0	-	79,5	144	-	-	-	81,0	79,0	-	-	144	-	-	-	81,0	79,0	-	-	-	-	148	-	-	-	-	-	-	55,0														
130	-	-	-	-	-	-	74,5	146	-	-	-	79,0	-	-	146	-	-	-	79,0	-	-	-	-	-	-	150	-	-	-	-	-	-	51,0														
134	-	-	-	-	-	-	68,0	148	-	-	-	-	-	-	148	-	-	-	-	-	-	-	-	-	-	152	-	-	-	-	-	-	47,1														
138	-	-	-	-	-	-	64,5	150	-	-	-	-	-	-	150	-	-	-	-	-	-	-	-	-	-	154	-	-	-	-	-	-	41,1														
142	-	-	-	-	-	-	64,5	152	-	-	-	-	-	-	152	-	-	-	-	-	-	-	-	-	156	-	-	-	-	-	-	37,1															
146	-	-	-	-	-	-	44,3	154	-	-	-	-	-	-	154	-	-	-	-	-	-	-	-	-	158	-	-	-	-	-	-	29,2															

0 t 100 t 180 t 240 t 340 t 440 t 540 t 640 t

6 m steps of luffing jib is standard · 6 m Stufung der Wippe ist Standard · Des paliers de 6 m sont de série pour la fléchette · Falcone standard con sezioni di 6 m · Incrementos de 6 m para plumín abatible son estándar · Lances de 6 m da lança auxiliar como padrão · 6 m шаг размера гуська является стандартом

* Main boom angle 88° · Hauptauslegerwinkel 88° · Jarret de flèche principale 88° · Inclinazione braccio base 88° · Ángulo de pluma principal 88° · Ángulo da lança principal 88° · Угол подъема гл. стрелы 88°

Main boom angle 88°, 85°, 75°, 65°, 55° and 45°; capacities for intermediate boom positions are calculated by the crane control system IC-1 Hauptauslegerwinkel 88°, 85°, 75°, 65°, 55° und 45°; Traglasten für Zwischenstellungen des Hauptauslegers werden von der Kransteuerung IC-1 berechnet

Jarret de flèche principale 88°, 85°, 75°, 65°, 55° et 45°; le système de commande de la grue IC-1 calcule les charges pour les positions intermédiaires de la flèche

Inclinazione braccio base 88°, 85°, 75°, 65°, 55° e 45°; capacità per posizioni intermedie del braccio sono calcolate dal sistema di controllo della gru IC-1

Ángulo de pluma principal 88°, 85°, 75°, 65°, 55° y 45° las capacidades para posiciones de pluma intermedias son calculadas por el sistema de control de grúa IC-1

Ángulos da lança principal 88°, 85°, 75°, 65°, 55° e 45°; as capacidades para posições da lança intermediária são calculadas pelo sistema de controle da grua IC-1

Грузоподъемность при углах подъема главной стрелы 88°, 85°, 75°, 65°, 55° и 45°, грузоподъемность в промежуточных положениях стрелы рассчитывается системой управления краном IC-1

295 t + 60 t 19-30 m 10,5 m 9.8 m/s 360° ISO											
78 m + 108 m											
SWSL					SFSL						
0 t		0 t - 640 t									
88°/85°		88°/85°		75°		65°		55°		45°	
m	t	t	t	t	t	t	t	t	t		
40	103,0*	126,0*	-	-	-	-	-	-	-		
42	97,0*	125,0*	-	-	-	-	-	-	-		
46	85,5*	123,0*	-	-	-	-	-	-	-		
50	76,0*	127,0	-	-	-	-	-	-	127,0		
54	67,0*	126,0	-	-	-	-	-	-	127,0		
58	59,5*	125,0	-	-	-	-	-	-	126,0		
62	53,0*	123,0	-	-	-	-	-	-	126,0		
66	47,0*	121,0	-	-	-	-	-	-	125,0		
70	41,5*	119,0	-	-	-	-	-	-	124,0		
74	36,6*	117,0	-	-	-	-	-	-	123,0		
78	32,1*	115,0	-	-	-	-	-	-	121,0		
80	30,0*	115,0	119,0	-	-	-	-	-	120,0		
82	28,0*	114,0	119,0	-	-	-	-	-	119,0		
86	24,3*	111,5	119,0	-	-	-	-	-	117,0		
90	20,8*	106,5	119,0	-	-	-	-	-	115,0		
92	19,2*	103,0	119,0	-	-	-	-	-	113,5		
94	17,6*	99,7	119,0	-	-	-	-	-	112,0		
98	14,7*	93,2	118,0	-	-	-	-	-	110,0		
102	12,0*	86,5	118,0	-	-	-	-	-	108,0		
104	10,7*	83,0	114,0	-	-	-	-	-	107,0		
106	-	78,5	109,0	-	-	-	-	-	106,0		
108	-	74,0	105,0	104,0	-	-	-	-	105,0		
110	-	69,0	101,0	104,0	-	-	-	-	104,0		
112	-	64,0	97,5	104,0	-	-	-	-	102,5		
114	-	-	93,5	104,0	-	-	-	-	101,0		
118	-	-	86,5	104,0	-	-	-	-	99,5		
122	-	-	80,0	103,0	-	-	-	-	97,5		
126	-	-	70,5	95,5	-	-	-	-	90,5		
130	-	-	-	88,5	-	-	-	-	83,5		
134	-	-	-	81,5	78,0	-	-	-	76,0		
138	-	-	-	76,0	73,5	-	-	-	67,5		
142	-	-	-	-	69,5	-	-	-	59,5		
146	-	-	-	-	66,0	-	-	-	51,5		
150	-	-	-	-	62,5	-	-	-	44,2		
154	-	-	-	-	-	-	-	38,5	36,9		
158	-	-	-	-	-	-	-	35,9	31,6		
160	-	-	-	-	-	-	-	34,7	29,5		
162	-	-	-	-	-	-	-	-	27,5		
166	-	-	-	-	-	-	-	-	21,5		
170	-	-	-	-	-	-	-	-	14,5		

84 m + 36 m											
SWSL					SFSL						
0 t		0 t - 640 t									
88°/85°		88°/85°		75°		65°		55°		45°	
m	t	t	t	t	t	t	t	t	t		
20	307,0*	411,0*	-	-	-	-	-	-	-		
22	282,0*	399,0*	-	-	-	-	-	-	-		
24	260,0*	386,0*	-	-	-	-	-	-	-		
26	241,0*	430,0	-	-	-	-	-	-	419,0		
28	224,0*	421,0	-	-	-	-	-	-	419,0		
30	210,0*	412,0	-	-	-	-	-	-	419,0		
34	185,0*	392,0	-	-	-	-	-	-	419,0		
38	165,0*	374,0	-	-	-	-	-	-	419,0		
40	156,0*	366,0	-	-	-	-	-	-	419,0		
42	134,0	358,0	-	-	-	-	-	-	417,0		
44	126,0	334,0	-	-	-	-	-	-	409,0		
45	-	-	430,0	-	-	-	-	-	402,5		
46	-	-	430,0	-	-	-	-	-	397,0		
50	-	-	417,0	-	-	-	-	-	380,0		
54	-	-	385,0	-	-	-	-	-	365,0		
58	-	-	340,0	-	-	-	-	-	332,0		
62	-	-	-	-	-	-	-	-	302,0		
64	-	-	-	291,0	-	-	-	-	288,5		
66	-	-	-	281,0	-	-	-	-	275,0		
70	-	-	-	262,0	-	-	-	-	252,0		
73	-	-	-	250,0	-	-	-	-	236,2		
74	-	-	-	-	-	-	-	-	231,0		
78	-	-	-	-	-	-	-	-	213,0		
81	-	-	-	-	-	202,0	-	-	200,2		
82	-	-	-	-	-	199,0	-	-	196,0		
86	-	-	-	-	-	188,0	-	-	181,0		
90	-	-	-	-	-	-	-	-	167,0		
94	-	-	-	-	-	-	-	-	150,0		
95	-	-	-	-	-	-	-	147,0	145,7		
97	-	-	-	-	-	-	-	143,0	137,2		
98	-	-	-	-	-	-	-	-	133,0		
102	-	-	-	-	-	-	-	-	116,0		
106	-	-	-	-	-	-	-	-	100,0		

0 t 100 t 180 t 240 t 340 t 440 t 540 t 640 t

6 m steps of luffing jib is standard · 6 m Stufung der Wippe ist Standard · Des paliers de 6 m sont de série pour la fléchette · Falcone standard con sezioni di 6 m · Incrementos de 6 m para plumín abatible son estándar · Lances de 6 m da lança auxiliar como padrão · 6 м шаг размера гуська является стандартом

* Main boom angle 88° · Hauptauslegerwinkel 88° · Jarret de flèche principale 88° · Inclinazione braccio base 88° · Ángulo de pluma principal 88° · Ángulo da lança principal 88° · Угол подъема гл. стрелы 88°

Main boom angle 88°, 85°, 75°, 65°, 55° and 45°; capacities for intermediate boom positions are calculated by the crane control system IC-1 · Hauptauslegerwinkel 88°, 85°, 75°, 65°, 55° und 45°; Traglasten für Zwischenstellungen des Hauptauslegers werden von der Kransteuerung IC-1 berechnet

Jarret de flèche principale 88°, 85°, 75°, 65°, 55° et 45°; le système de commande de la grue IC-1 calcule les charges pour les positions intermédiaires de la flèche

Inclinazione braccio base 88°, 85°, 75°, 65°, 55° e 45°; capacità per posizioni intermedie del braccio sono calcolate dal sistema di controllo della gru IC-1

Ángulo de pluma principal 88°, 85°, 75°, 65°, 55° y 45° las capacidades para posiciones de pluma intermedias son calculadas por el sistema de control de grúa IC-1

Ángulos da lança principal 88°, 85°, 75°, 65°, 55° e 45°; as capacidades para posições da lança intermediária são calculadas pelo sistema de controle da grua IC-1

Грузоподъемность при углах подъема главной стрелы 88°, 85°, 75°, 65°, 55° и 45°, грузоподъемность в промежуточных положениях стрелы рассчитывается системой управления краном IC-1

295 t + 60 t								19-30 m		10,5 m		9.8 m/s		360°		ISO								
84 m + 48 m										84 m + 60 m														
SWSL				SFSL				SWSL				SFSL												
0 t		0 t - 640 t						0 t		0 t - 640 t														
88°/85°		88°/85°		75°		65°		55°		45°		88°/85°		88°/85°		75°		65°		55°		45°		
m	t	t	t	t	t	t	t	m	t	t	t	t	t	t	t	t	m	t	t	t	t	t	t	
24	243,0*	330,0*	-	-	-	-	-	26	212,0*	270,0*	-	-	-	-	-	-	28	198,0*	268,0*	-	-	-	-	-
26	226,0*	322,0*	-	-	-	-	-	28	198,0*	268,0*	-	-	-	-	-	-	30	185,0*	263,0*	-	-	-	-	-
28	210,0*	314,0*	-	-	-	-	-	30	185,0*	263,0*	-	-	-	-	-	-	34	162,0*	281,0	-	-	-	-	275,0
30	196,0*	347,0	-	-	-	-	337,0	34	162,0*	281,0	-	-	-	-	-	-	38	144,0*	275,0	-	-	-	-	275,0
34	173,0*	335,0	-	-	-	-	337,0	38	144,0*	275,0	-	-	-	-	-	-	42	129,0*	267,0	-	-	-	-	275,0
38	154,0*	323,0	-	-	-	-	337,0	42	129,0*	267,0	-	-	-	-	-	-	46	116,0*	259,0	-	-	-	-	275,0
42	138,0*	310,0	-	-	-	-	337,0	46	116,0*	259,0	-	-	-	-	-	-	50	105,0*	251,0	-	-	-	-	275,0
46	124,0*	298,0	-	-	-	-	337,0	50	105,0*	251,0	-	-	-	-	-	-	54	95,5*	243,0	-	-	-	-	271,0
50	112,0*	288,0	-	-	-	-	329,0	54	95,5*	243,0	-	-	-	-	-	-	58	87,0*	234,0	289,0	-	-	-	264,0
52	105,0*	279,0	353,0	-	-	-	323,5	58	87,0*	234,0	289,0	-	-	-	-	-	62	79,5*	225,0	284,0	-	-	-	256,0
54	90,0	263,0	352,0	-	-	-	318,0	62	79,5*	225,0	284,0	-	-	-	-	-	66	63,5	199,0	279,0	-	-	-	246,0
56	85,0	247,0	348,0	-	-	-	309,0	66	63,5	199,0	279,0	-	-	-	-	-	68	60,0	182,0	275,0	-	-	-	242,5
58	-	-	342,0	-	-	-	304,0	68	60,0	182,0	275,0	-	-	-	-	-	70	-	-	266,0	-	-	-	239,0
62	-	-	320,0	-	-	-	293,0	70	-	-	266,0	-	-	-	-	-	74	-	-	239,0	-	-	-	232,0
66	-	-	283,0	-	-	-	279,0	74	-	-	239,0	-	-	-	-	-	78	-	-	217,0	-	-	-	221,0
70	-	-	253,0	-	-	-	255,0	78	-	-	217,0	-	-	-	-	-	79	-	-	212,0	219,0	-	-	216,7
72	-	-	-	248,0	-	-	244,5	79	-	-	212,0	219,0	-	-	-	-	82	-	-	198,0	209,0	-	-	204,0
74	-	-	-	240,0	-	-	234,0	82	-	-	198,0	209,0	-	-	-	-	86	-	-	-	197,0	-	-	189,0
78	-	-	-	225,0	-	-	215,0	86	-	-	-	197,0	-	-	-	-	90	-	-	-	187,0	-	-	175,0
82	-	-	-	212,0	-	-	199,0	90	-	-	-	187,0	-	-	-	-	94	-	-	-	177,0	-	-	162,0
84	-	-	-	206,0	-	-	191,0	94	-	-	-	177,0	-	-	-	-	96	-	-	-	172,0	-	-	156,0
86	-	-	-	-	-	-	183,0	96	-	-	-	172,0	-	-	-	-	98	-	-	-	-	-	-	150,0
90	-	-	-	-	-	171,0	169,0	98	-	-	-	-	-	-	-	-	99	-	-	-	-	148,0	-	147,2
94	-	-	-	-	-	162,0	157,0	99	-	-	-	-	-	-	-	-	102	-	-	-	-	143,0	-	139,0
97	-	-	-	-	-	156,0	148,0	102	-	-	-	-	-	-	-	-	106	-	-	-	-	136,0	-	129,0
98	-	-	-	-	-	-	145,0	106	-	-	-	-	-	-	-	-	108	-	-	-	-	133,0	-	123,5
102	-	-	-	-	-	-	131,0	108	-	-	-	-	-	-	-	-	110	-	-	-	-	-	-	118,0
106	-	-	-	-	-	-	119,0	110	-	-	-	-	-	-	-	-	114	-	-	-	-	-	-	105,0
109	-	-	-	-	-	-	115,0	114	-	-	-	-	-	-	-	-	116	-	-	-	-	-	-	99,2
110	-	-	-	-	-	-	103,0	116	-	-	-	-	-	-	-	-	118	-	-	-	-	-	-	93,5
114	-	-	-	-	-	-	89,5	118	-	-	-	-	-	-	-	-	120	-	-	-	-	-	-	87,5
118	-	-	-	-	-	-	77,5	120	-	-	-	-	-	-	-	-	122	-	-	-	-	-	-	81,5
								122	-	-	-	-	-	-	-	-	126	-	-	-	-	-	-	70,0
								126	-	-	-	-	-	-	-	-	130	-	-	-	-	-	-	62,0
								130	-	-	-	-	-	-	-	-								



6 m steps of luffing jib is standard · 6 m Stufung der Wippe ist Standard · Des paliers de 6 m sont de série pour la fléchette · Falcone standard con sezioni di 6 m · Incrementos de 6 m para plumín abatible son estándar · Lances de 6 m da lança auxiliar como padrão · 6 м шаг размера гуська является стандартом

* Main boom angle 88° · Hauptauslegerwinkel 88° · Jarret de flèche principale 88° · Inclinazione braccio base 88° · Ángulo de pluma principal 88° · Ángulo da lança principal 88° · Угол подъема гл. стрелы 88°

Main boom angle 88°, 85°, 75°, 65°, 55° and 45°; capacities for intermediate boom positions are calculated by the crane control system IC-1 · Hauptauslegerwinkel 88°, 85°, 75°, 65°, 55° und 45°; Traglasten für Zwischenstellungen des Hauptauslegers werden von der Kransteuerung IC-1 berechnet

Jarret de flèche principale 88°, 85°, 75°, 65°, 55° et 45°; le système de commande de la grue IC-1 calcule les charges pour les positions intermédiaires de la flèche

Inclinazione braccio base 88°, 85°, 75°, 65°, 55° e 45°; capacità per posizioni intermedie del braccio sono calcolate dal sistema di controllo della gru IC-1

Ángulo de pluma principal 88°, 85°, 75°, 65°, 55° y 45° las capacidades para posiciones de pluma intermedias son calculadas por el sistema de control de grúa IC-1

Ángulos da lança principal 88°, 85°, 75°, 65°, 55° e 45°; as capacidades para posições da lança intermediária são calculadas pelo sistema de controle da grua IC-1

Грузоподъемность при углах подъема главной стрелы 88°, 85°, 75°, 65°, 55° и 45°, грузоподъемность в промежуточных положениях стрелы рассчитывается системой управления краном IC-1

295 t + 60 t 19-30 m								10,5 m 9.8 m/s 360° ISO							
84 m + 72 m								84 m + 84 m							
SWSL				SFSL				SWSL				SFSL			
0 t		0 t - 640 t						0 t		0 t - 640 t					
	88°/85°	88°/85°	75°	65°	55°	45°			88°/85°	88°/85°	75°	65°	55°	45°	
m	t	t	t	t	t	t	t	m	t	t	t	t	t	t	t
30	173,0*	220,0*	-	-	-	-	-	34	140,0*	180,0*	-	-	-	-	-
34	152,0*	215,0*	-	-	-	-	-	38	124,0*	175,0*	-	-	-	-	-
38	135,0*	230,0	-	-	-	-	224,0	42	110,0*	186,0	-	-	-	-	182,0
42	120,0*	225,0	-	-	-	-	224,0	46	98,0*	184,0	-	-	-	-	182,0
46	108,0*	220,0	-	-	-	-	224,0	50	87,5*	180,0	-	-	-	-	182,0
50	97,5*	215,0	-	-	-	-	224,0	54	78,5*	177,0	-	-	-	-	182,0
54	88,0*	209,0	-	-	-	-	224,0	58	71,0*	173,0	-	-	-	-	182,0
58	80,0*	204,0	-	-	-	-	224,0	62	64,0*	169,0	-	-	-	-	182,0
62	72,5*	199,0	-	-	-	-	219,0	66	57,5*	166,0	-	-	-	-	180,0
64	69,5*	195,0	233,0	-	-	-	216,5	70	52,0*	162,0	186,0	-	-	-	177,0
66	66,5*	192,0	233,0	-	-	-	214,0	74	47,0*	157,0	186,0	-	-	-	174,0
70	60,5*	185,0	232,0	-	-	-	210,0	78	42,5*	152,0	186,0	-	-	-	171,0
74	55,5*	169,0	226,0	-	-	-	205,0	82	38,4*	141,0	185,0	-	-	-	168,0
78	42,4	147,0	222,0	-	-	-	198,0	84	36,4*	133,0	182,0	-	-	-	164,5
82	-	-	202,0	-	-	-	193,0	86	26,6	125,0	179,0	-	-	-	163,0
86	-	-	185,0	-	-	-	188,0	88	24,9	117,0	172,0	-	-	-	161,5
88	-	-	177,0	187,0	-	-	182,5	90	-	-	164,0	-	-	-	160,0
90	-	-	170,0	181,0	-	-	177,0	94	-	-	151,0	-	-	-	157,0
94	-	-	150,0	172,0	-	-	164,0	96	-	-	145,0	158,0	-	-	153,0
98	-	-	-	163,0	-	-	152,0	98	-	-	139,0	154,0	-	-	149,0
102	-	-	-	154,0	-	-	141,0	102	-	-	-	145,0	-	-	138,0
106	-	-	-	147,0	-	-	131,0	104	-	-	121,0	142,0	-	-	133,0
108	-	-	-	-	127,0	-	126,0	106	-	-	-	138,0	-	-	128,0
110	-	-	-	-	124,0	-	121,0	110	-	-	-	131,0	-	-	118,0
114	-	-	-	-	118,0	-	112,0	114	-	-	-	125,0	-	-	110,0
118	-	-	-	-	113,0	-	103,0	118	-	-	-	119,0	103,0	-	101,0
120	-	-	-	-	110,0	-	97,7	122	-	-	-	-	98,5	-	94,0
122	-	-	-	-	-	-	92,5	126	-	-	-	-	93,5	-	85,5
126	-	-	-	-	-	-	81,5	130	-	-	-	-	89,5	-	75,5
128	-	-	-	-	-	-	80,0	132	-	-	-	-	87,5	-	71,0
130	-	-	-	-	-	-	78,0	134	-	-	-	-	-	-	66,5
134	-	-	-	-	-	-	61,0	138	-	-	-	-	-	60,0	57,5
138	-	-	-	-	-	-	52,0	142	-	-	-	-	-	57,0	48,7
142	-	-	-	-	-	-	47,8	146	-	-	-	-	-	-	41,5
								150	-	-	-	-	-	-	37,2
								154	-	-	-	-	-	-	29,5

0 t 100 t 180 t 240 t 340 t 440 t 540 t 640 t

6 m steps of luffing jib is standard · 6 m Stufung der Wippe ist Standard · Des paliers de 6 m sont de série pour la fléchette · Falcone standard con sezioni di 6 m · Incrementos de 6 m para plumín abatible son estándar · Lances de 6 m da lança auxiliar como padrão · 6 м шаг размера гуська является стандартом

* Main boom angle 88° · Hauptauslegerwinkel 88° · Jarret de flèche principale 88° · Inclinação braccio base 88° · Ângulo de pluma principal 88° · Ângulo da lança principal 88° · Угол подъема гл. стрелы 88°

Main boom angle 88°, 85°, 75°, 65°, 55° and 45°; capacities for intermediate boom positions are calculated by the crane control system IC-1 · Hauptauslegerwinkel 88°, 85°, 75°, 65°, 55° und 45°; Traglasten für Zwischenstellungen des Hauptauslegers werden von der Kransteuerung IC-1 berechnet

Jarret de flèche principale 88°, 85°, 75°, 65°, 55° et 45°; le système de commande de la grue IC-1 calcule les charges pour les positions intermédiaires de la flèche

Inclinação braccio base 88°, 85°, 75°, 65°, 55° e 45°; capacità per posizioni intermedie del braccio sono calcolate dal sistema di controllo della gru IC-1

Ângulo de pluma principal 88°, 85°, 75°, 65°, 55° y 45° las capacidades para posiciones de pluma intermedias son calculadas por el sistema de control de grúa IC-1

Ângulos da lança principal 88°, 85°, 75°, 65°, 55° e 45°; as capacidades para posições da lança intermediária são calculadas pelo sistema de controle da grua IC-1

Грузоподъемность при углах подъема главной стрелы 88°, 85°, 75°, 65°, 55° и 45°, грузоподъемность в промежуточных положениях стрелы рассчитывается системой управления краном IC-1

295 t + 60 t 19-30 m 10,5 m 9.8 m/s 360° ISO								84 m + 96 m								84 m + 108 m							
SWSL				SFSL				SWSL				SFSL				SWSL				SFSL			
0 t		0 t - 640 t						0 t		0 t - 640 t						0 t		0 t - 640 t					
88°/85°		88°/85°		75°		65°		55°		45°		88°/85°		88°/85°		75°		65°		55°		45°	
m	t	t	t	t	t	t	t	m	t	t	t	t	t	t	t	m	t	t	t	t	t	t	
38	115,0*	145,0*	-	-	-	-	-	40	99,5*	117,0*	-	-	-	-	-	40	99,5*	117,0*	-	-	-	-	-
42	101,0*	142,0*	-	-	-	-	-	42	93,0*	117,0*	-	-	-	-	-	42	93,0*	117,0*	-	-	-	-	-
46	90,0*	150,0	-	-	-	-	147,0	46	82,0*	114,0*	-	-	-	-	-	46	82,0*	114,0*	-	-	-	-	-
50	80,0*	148,0	-	-	-	-	147,0	50	72,5*	119,0	-	-	-	-	-	50	72,5*	119,0	-	-	-	-	118,0
54	71,5*	146,0	-	-	-	-	147,0	54	64,0*	118,0	-	-	-	-	-	54	64,0*	118,0	-	-	-	-	118,0
58	63,5*	143,0	-	-	-	-	147,0	58	57,0*	116,0	-	-	-	-	-	58	57,0*	116,0	-	-	-	-	118,0
62	57,0*	141,0	-	-	-	-	147,0	62	50,5*	114,0	-	-	-	-	-	62	50,5*	114,0	-	-	-	-	117,0
66	51,0*	138,0	-	-	-	-	147,0	66	44,6*	113,0	-	-	-	-	-	66	44,6*	113,0	-	-	-	-	117,0
70	45,6*	136,0	-	-	-	-	146,0	70	39,3*	111,0	-	-	-	-	-	70	39,3*	111,0	-	-	-	-	116,0
74	40,7*	133,0	-	-	-	-	144,0	74	34,5*	109,0	-	-	-	-	-	74	34,5*	109,0	-	-	-	-	116,0
76	38,4*	132,0	146,0	-	-	-	143,0	76	30,2*	107,0	-	-	-	-	-	76	30,2*	107,0	-	-	-	-	114,0
78	36,2*	131,0	146,0	-	-	-	142,0	78	26,2*	106,0	112,0	-	-	-	-	78	26,2*	106,0	112,0	-	-	-	112,0
82	32,1*	127,0	146,0	-	-	-	140,0	82	22,5*	104,0	112,0	-	-	-	-	82	22,5*	104,0	112,0	-	-	-	110,0
86	28,4*	123,0	146,0	-	-	-	138,0	86	20,8*	103,0	112,0	-	-	-	-	86	20,8*	103,0	112,0	-	-	-	109,0
90	24,9*	117,5	146,0	-	-	-	136,0	90	19,1*	100,2	112,0	-	-	-	-	90	19,1*	100,2	112,0	-	-	-	108,0
94	21,8*	108,0	146,0	-	-	-	134,0	94	16,0*	94,5	112,0	-	-	-	-	94	16,0*	94,5	112,0	-	-	-	106,0
96	20,4*	102,0	143,0	-	-	-	131,0	96	13,1*	88,7	112,0	-	-	-	-	96	13,1*	88,7	112,0	-	-	-	105,0
98	11,7	95,7	137,0	-	-	-	130,0	98	11,8*	86,0	112,0	-	-	-	-	98	11,8*	86,0	112,0	-	-	-	104,0
100	10,5	89,5	132,0	-	-	-	129,0	100	-	83,2	112,0	-	-	-	-	100	-	83,2	112,0	-	-	-	103,0
102	-	-	127,0	-	-	-	128,0	102	-	77,7	112,0	-	-	-	-	102	-	77,7	112,0	-	-	-	101,0
104	-	-	122,0	124,0	-	-	127,0	104	-	75,0	108,0	-	-	-	-	104	-	75,0	108,0	-	-	-	99,0
106	-	-	117,0	124,0	-	-	126,0	106	-	70,2	104,0	97,5	-	-	-	106	-	70,2	104,0	97,5	-	-	98,0
110	-	-	108,0	123,0	-	-	119,0	110	-	65,5	100,0	97,5	-	-	-	110	-	65,5	100,0	97,5	-	-	97,0
114	-	-	99,5	120,0	-	-	111,0	114	-	-	96,0	97,5	-	-	-	114	-	-	96,0	97,5	-	-	96,0
116	-	-	93,0	117,0	-	-	106,5	116	-	-	89,0	97,5	-	-	-	116	-	-	89,0	97,5	-	-	94,0
118	-	-	-	114,0	-	-	102,0	118	-	-	82,5	97,5	-	-	-	118	-	-	82,5	97,5	-	-	92,0
122	-	-	-	108,0	-	-	95,0	122	-	-	74,5	97,0	-	-	-	122	-	-	74,5	97,0	-	-	86,5
126	-	-	-	103,0	-	-	87,5	126	-	-	69,5	94,5	-	-	-	126	-	-	69,5	94,5	-	-	83,0
128	-	-	-	101,0	86,0	-	84,2	128	-	-	-	92,5	-	-	-	128	-	-	-	92,5	-	-	79,5
130	-	-	-	97,5	84,0	-	81,0	130	-	-	-	85,5	-	-	-	130	-	-	-	85,5	-	-	73,0
134	-	-	-	-	80,0	-	73,0	134	-	-	-	82,5	71,5	-	-	134	-	-	-	82,5	71,5	-	70,0
138	-	-	-	-	76,0	-	64,0	138	-	-	-	79,5	69,5	-	-	138	-	-	-	79,5	69,5	-	67,0
142	-	-	-	-	73,0	-	56,0	142	-	-	-	74,0	66,0	-	-	142	-	-	-	74,0	66,0	-	59,0
146	-	-	-	-	-	-	48,1	146	-	-	-	-	62,0	-	-	146	-	-	-	-	62,0	-	51,5
148	-	-	-	-	-	-	46,2	148	-	-	-	-	58,5	-	-	148	-	-	-	-	58,5	-	44,5
150	-	-	-	-	-	-	44,8	150	-	-	-	-	55,5	-	-	150	-	-	-	-	55,5	-	37,3
154	-	-	-	-	-	-	42,0	154	-	-	-	-	-	-	-	154	-	-	-	-	-	-	30,4
158	-	-	-	-	-	-	28,7	158	-	-	-	-	-	-	-	158	-	-	-	-	-	-	23,6
162	-	-	-	-	-	-	23,4	162	-	-	-	-	-	-	-	162	-	-	-	-	-	-	18,6
166	-	-	-	-	-	-	-	166	-	-	-	-	-	-	-	166	-	-	-	-	-	-	14,7
170	-	-	-	-	-	-	-	170	-	-	-	-	-	-	-	170	-	-	-	-	-	-	14,7

0 t 100 t 180 t 240 t 340 t 440 t 540 t 640 t

6 m steps of luffing jib is standard · 6 m Stufung der Wippe ist Standard · Des paliers de 6 m sont de série pour la fléchette · Falcone standard con sezioni di 6 m · Incrementos de 6 m para plumín abatible son estándar · Lances de 6 m da lança auxiliar como padrão · 6 m шаг размера гуська является стандартом

* Main boom angle 88° · Hauptauslegerwinkel 88° · Jarret de flèche principale 88° · Inclinazione braccio base 88° · Ángulo de pluma principal 88° · Ángulo da lança principal 88° · Угол подъема гл. стрелы 88°

Main boom angle 88°, 85°, 75°, 65°, 55° and 45°; capacities for intermediate boom positions are calculated by the crane control system IC-1 · Hauptauslegerwinkel 88°, 85°, 75°, 65°, 55° und 45°; Traglasten für Zwischenstellungen des Hauptauslegers werden von der Kransteuerung IC-1 berechnet

Jarret de flèche principale 88°, 85°, 75°, 65°, 55° et 45°; le système de commande de la grue IC-1 calcule les charges pour les positions intermédiaires de la flèche

Inclinazione braccio base 88°, 85°, 75°, 65°, 55° e 45°; capacità per posizioni intermedie del braccio sono calcolate dal sistema di controllo della gru IC-1

Ángulo de pluma principal 88°, 85°, 75°, 65°, 55° y 45° las capacidades para posiciones de pluma intermedias son calculadas por el sistema de control de grúa IC-1

Ángulos da lança principal 88°, 85°, 75°, 65°, 55° e 45°; as capacidades para posições da lança intermediária são calculadas pelo sistema de controle da grua IC-1

Грузоподъемность при углах подъема главной стрелы 88°, 85°, 75°, 65°, 55° и 45°, грузоподъемность в промежуточных положениях стрелы рассчитывается системой управления краном IC-1

295 t + 60 t 19-30 m									10,5 m 9.8 m/s 360° ISO								
90 m + 36 m									90 m + 48 m								
SWSL SFSL									SWSL SFSL								
0 t 0 t - 640 t									0 t 0 t - 640 t								
88°/85° 88°/85° 75° 65° 55° 45°									88°/85° 88°/85° 75° 65° 55° 45°								
m	t	t	t	t	t	t	t	t	m	t	t	t	t	t	t	t	t
20	296,0*	375,0*	-	-	-	-	-	-	24	235,0*	303,0*	-	-	-	-	-	-
22	272,0*	364,0*	-	-	-	-	-	-	26	218,0*	295,0*	-	-	-	-	-	-
24	251,0*	353,0*	-	-	-	-	-	-	28	203,0*	288,0*	-	-	-	-	-	-
26	233,0*	394,0	-	-	-	-	-	381,0	30	190,0*	316,0	-	-	-	-	-	309,0
28	217,0*	385,0	-	-	-	-	-	381,0	34	167,0*	307,0	-	-	-	-	-	309,0
30	203,0*	376,0	-	-	-	-	-	381,0	38	149,0*	296,0	-	-	-	-	-	309,0
34	179,0*	358,0	-	-	-	-	-	381,0	42	133,0*	284,0	-	-	-	-	-	309,0
38	160,0*	341,0	-	-	-	-	-	381,0	46	120,0*	272,0	-	-	-	-	-	309,0
40	152,0*	334,0	-	-	-	-	-	381,0	50	109,0*	263,0	-	-	-	-	-	304,0
42	129,0	328,0	-	-	-	-	-	381,0	52	104,0*	258,0	-	-	-	-	-	300,0
44	122,0	321,0	-	-	-	-	-	377,0	54	87,5	254,0	321,0	-	-	-	-	296,0
46	-	-	-	-	-	-	-	370,0	56	83,0	249,0	317,0	-	-	-	-	291,0
47	-	-	393,0	-	-	-	-	367,0	58	-	-	313,0	-	-	-	-	286,0
50	-	-	389,0	-	-	-	-	352,0	62	-	-	303,0	-	-	-	-	274,0
54	-	-	374,0	-	-	-	-	340,0	66	-	-	293,0	-	-	-	-	265,0
58	-	-	349,0	-	-	-	-	328,0	70	-	-	263,0	-	-	-	-	251,0
60	-	-	334,0	-	-	-	-	312,5	72	-	-	249,0	-	-	-	-	240,5
62	-	-	-	-	-	-	-	297,0	74	-	-	-	232,0	-	-	-	230,0
66	-	-	-	-	-	-	-	271,0	78	-	-	-	218,0	-	-	-	211,0
67	-	-	-	268,0	-	-	-	265,0	82	-	-	-	205,0	-	-	-	194,0
70	-	-	-	255,0	-	-	-	247,0	86	-	-	-	194,0	-	-	-	179,0
74	-	-	-	239,0	-	-	-	227,0	90	-	-	-	-	-	-	-	165,0
76	-	-	-	232,0	-	-	-	217,5	94	-	-	-	-	155,0	-	-	152,0
78	-	-	-	-	-	-	-	208,0	98	-	-	-	-	147,0	-	-	141,0
82	-	-	-	-	-	-	-	191,0	100	-	-	-	-	143,0	-	-	135,5
84	-	-	-	-	185,0	-	-	183,5	102	-	-	-	-	-	-	-	130,0
86	-	-	-	-	180,0	-	-	176,0	106	-	-	-	-	-	-	-	119,0
89	-	-	-	-	173,0	-	-	165,5	110	-	-	-	-	-	-	108,0	106,0
90	-	-	-	-	-	-	-	162,0	113	-	-	-	-	-	-	104,0	96,2
94	-	-	-	-	-	-	-	150,0	114	-	-	-	-	-	-	-	93,0
98	-	-	-	-	-	-	-	136,0	118	-	-	-	-	-	-	-	80,5
102	-	-	-	-	-	-	-	121,0	122	-	-	-	-	-	-	-	68,0
106	-	-	-	-	-	-	-	106,0									
110	-	-	-	-	-	-	-	91,0									

0 t
100 t
180 t
240 t
340 t
440 t
540 t
640 t

6 m steps of luffing jib is standard · 6 m Stufung der Wippe ist Standard · Des paliers de 6 m sont de série pour la fléchette · Falcone standard con sezioni di 6 m · Incrementos de 6 m para plumín abatible son estándar · Lances de 6 m da lança auxiliar como padrão · 6 м шаг размера гуська является стандартом

* Main boom angle 88° · Hauptauslegerwinkel 88° · Jarret de flèche principale 88° · Inclinação braccio base 88° · Ángulo de pluma principal 88° · Ángulo da lança principal 88° · Угол подъема гл. стрелы 88°

Main boom angle 88°, 85°, 75°, 65°, 55° and 45°; capacities for intermediate boom positions are calculated by the crane control system IC-1 · Hauptauslegerwinkel 88°, 85°, 75°, 65°, 55° und 45°; Traglasten für Zwischenstellungen des Hauptauslegers werden von der Kransteuerung IC-1 berechnet

Jarret de flèche principale 88°, 85°, 75°, 65°, 55° et 45°; le système de commande de la grue IC-1 calcule les charges pour les positions intermédiaires de la flèche

Inclinação braccio base 88°, 85°, 75°, 65°, 55° e 45°; capacità per posizioni intermedie del braccio sono calcolate dal sistema di controllo della gru IC-1

Ángulo de pluma principal 88°, 85°, 75°, 65°, 55° y 45° las capacidades para posiciones de pluma intermedias son calculadas por el sistema de control de grúa IC-1

Ángulos da lança principal 88°, 85°, 75°, 65°, 55° e 45°; as capacidades para posições da lança intermediária são calculadas pelo sistema de controle da grua IC-1

Грузоподъемность при углах подъема главной стрелы 88°, 85°, 75°, 65°, 55° и 45°, грузоподъемность в промежуточных положениях стрелы рассчитывается системой управления краном IC-1

295 t + 60 t									19-30 m									10,5 m									9.8 m/s									360°									ISO								
90 m + 60 m																		90 m + 72 m																																			
SWSL																		SFSL																																			
0 t									0 t - 640 t									0 t									0 t - 640 t																										
88°/85°									88°/85°									75°									65°									55°									45°								
m	t	t	t	t	t	t	t	t	m	t	t	t	t	t	t	t	t	m	t	t	t	t	t	t	t	t	m	t	t	t	t	t	t	t	t																		
26	205,0*	249,0*	-	-	-	-	-	-	30	168,0*	203,0*	-	-	-	-	-	-	34	147,0*	198,0*	-	-	-	-	-	-	-	-																									
28	191,0*	247,0*	-	-	-	-	-	-	34	147,0*	198,0*	-	-	-	-	-	-	38	130,0*	211,0	-	-	-	-	-	-	-	206,0																									
30	179,0*	242,0*	-	-	-	-	-	-	38	130,0*	211,0	-	-	-	-	-	-	42	116,0*	207,0	-	-	-	-	-	-	-	206,0																									
34	157,0*	259,0	-	-	-	-	-	252,0	46	104,0*	202,0	-	-	-	-	-	-	50	94,0*	197,0	-	-	-	-	-	-	-	206,0																									
38	140,0*	253,0	-	-	-	-	-	252,0	54	85,0*	192,0	-	-	-	-	-	-	58	77,0*	187,0	-	-	-	-	-	-	-	206,0																									
42	125,0*	245,0	-	-	-	-	-	252,0	62	70,0*	181,0	-	-	-	-	-	-	66	64,0*	176,0	212,0	-	-	-	-	-	-	199,0																									
46	112,0*	237,0	-	-	-	-	-	252,0	70	58,5*	170,0	212,0	-	-	-	-	-	74	53,5*	164,0	211,0	-	-	-	-	-	-	195,0																									
50	102,0*	229,0	-	-	-	-	-	252,0	78	39,7	150,0	204,0	-	-	-	-	-	82	37,8	138,0	203,0	-	-	-	-	-	-	186,0																									
54	92,5*	221,0	-	-	-	-	-	251,0	80	-	138,0	203,0	-	-	-	-	-	86	-	202,0	202,0	-	-	-	-	-	-	181,0																									
58	84,5*	215,0	-	-	-	-	-	245,0	82	-	-	202,0	-	-	-	-	-	86	-	191,0	191,0	-	-	-	-	-	-	177,0																									
60	80,5*	211,0	262,0	-	-	-	-	242,0	86	-	-	191,0	-	-	-	-	-	90	-	175,0	175,0	175,0	-	-	-	-	-	173,0																									
62	77,0*	208,0	262,0	-	-	-	-	239,0	90	-	-	175,0	175,0	-	-	-	-	94	-	159,0	166,0	166,0	-	-	-	-	-	160,0																									
64	74,0*	204,0	261,0	-	-	-	-	236,0	94	-	-	159,0	166,0	-	-	-	-	98	-	157,0	157,0	157,0	-	-	-	-	-	148,0																									
66	60,0	201,0	255,0	-	-	-	-	233,0	98	-	-	157,0	157,0	-	-	-	-	102	-	149,0	149,0	149,0	-	-	-	-	-	137,0																									
68	57,5	187,0	252,0	-	-	-	-	227,0	106	-	-	142,0	142,0	-	-	-	-	106	-	142,0	142,0	142,0	-	-	-	-	-	127,0																									
70	-	-	249,0	-	-	-	-	224,0	110	-	-	135,0	135,0	-	-	-	-	110	-	135,0	135,0	135,0	-	-	-	-	-	117,0																									
74	-	-	243,0	-	-	-	-	218,0	112	-	-	114,0	114,0	114,0	-	-	-	-	112	-	114,0	114,0	114,0	-	-	-	-	113,0																									
78	-	-	225,0	-	-	-	-	211,0	114	-	-	112,0	112,0	112,0	-	-	-	-	114	-	112,0	112,0	112,0	-	-	-	-	109,0																									
82	-	-	204,0	203,0	-	-	-	200,0	118	-	-	106,0	106,0	106,0	-	-	-	-	118	-	106,0	106,0	106,0	-	-	-	-	100,0																									
84	-	-	195,0	197,0	-	-	-	192,5	122	-	-	102,0	102,0	102,0	-	-	-	-	122	-	102,0	102,0	102,0	-	-	-	-	93,0																									
86	-	-	191,0	191,0	-	-	-	185,0	124	-	-	99,5	99,5	99,5	-	-	-	-	124	-	99,5	99,5	99,5	-	-	-	-	88,0																									
90	-	-	181,0	181,0	-	-	-	171,0	126	-	-	83,0	83,0	83,0	-	-	-	-	126	-	83,0	83,0	83,0	-	-	-	-	83,0																									
94	-	-	171,0	171,0	-	-	-	158,0	130	-	-	73,0	73,0	73,0	-	-	-	-	130	-	73,0	73,0	73,0	-	-	-	-	73,0																									
98	-	-	163,0	163,0	-	-	-	146,0	132	-	-	71,5	71,5	71,5	-	-	-	-	132	-	71,5	71,5	71,5	-	-	-	-	68,2																									
102	-	-	-	191,0	-	-	-	135,0	134	-	-	69,5	69,5	69,5	-	-	-	-	134	-	69,5	69,5	69,5	-	-	-	-	63,5																									
104	-	-	-	181,0	-	-	-	130,0	136	-	-	67,5	67,5	67,5	-	-	-	-	136	-	67,5	67,5	67,5	-	-	-	-	58,7																									
106	-	-	-	129,0	-	-	-	125,0	138	-	-	54,0	54,0	54,0	-	-	-	-	138	-	54,0	54,0	54,0	-	-	-	-	54,0																									
110	-	-	-	123,0	-	-	-	116,0	142	-	-	44,8	44,8	44,8	-	-	-	-	142	-	44,8	44,8	44,8	-	-	-	-	44,8																									
112	-	-	-	120,0	-	-	-	111,5	146	-	-	40,7	40,7	40,7	-	-	-	-	146	-	40,7	40,7	40,7	-	-	-	-	40,7																									
114	-	-	-	-	-	-	-	107,0																																													
118	-	-	-	-	-	-	-	95,5																																													
120	-	-	-	-	-	-	-	91,0																																													
122	-	-	-	-	-	-	-	88,5																																													
124	-	-	-	-	-	-	-	86,0																																													
126	-	-	-	-	-	-	-	73,0																																													
130	-	-	-	-	-	-	-	62,5																																													
134	-	-	-	-	-	-	-	52,5																																													



6 m steps of luffing jib is standard · 6 m Stufung der Wippe ist Standard · Des paliers de 6 m sont de série pour la fléchette · Falcone standard con sezioni di 6 m · Incrementos de 6 m para plumín abatible son estándar · Lances de 6 m da lança auxiliar como padrão · 6 м шаг размера гуська является стандартом

* Main boom angle 88° · Hauptauslegerwinkel 88° · Jarret de flèche principale 88° · Inclinazione braccio base 88° · Ángulo de pluma principal 88° · Ángulo da lança principal 88° · Угол подъема гл. стрелы 88°

Main boom angle 88°, 85°, 75°, 65°, 55° and 45°; capacities for intermediate boom positions are calculated by the crane control system IC-1 · Hauptauslegerwinkel 88°, 85°, 75°, 65°, 55° und 45°; Traglasten für Zwischenstellungen des Hauptauslegers werden von der Kransteuerung IC-1 berechnet

Jarret de flèche principale 88°, 85°, 75°, 65°, 55° et 45°; le système de commande de la grue IC-1 calcule les charges pour les positions intermédiaires de la flèche

Inclinazione braccio base 88°, 85°, 75°, 65°, 55° e 45°; capacità per posizioni intermedie del braccio sono calcolate dal sistema di controllo della gru IC-1

Ángulo de pluma principal 88°, 85°, 75°, 65°, 55° y 45° las capacidades para posiciones de pluma intermedias son calculadas por el sistema de control de grúa IC-1

Ángulos da lança principal 88°, 85°, 75°, 65°, 55° e 45°; as capacidades para posições da lança intermediária são calculadas pelo sistema de controle da grua IC-1

Грузоподъемность при углах подъема главной стрелы 88°, 85°, 75°, 65°, 55° и 45°, грузоподъемность в промежуточных положениях стрелы рассчитывается системой управления краном IC-1

295 t + 60 t		19-30 m		10,5 m		9.8 m/s		360°		ISO	
90 m + 84 m		SWSL		SFSL		90 m + 96 m		SWSL		SFSL	
0 t		0 t - 640 t		0 t - 640 t		0 t		0 t - 640 t		0 t - 640 t	
88°/85°		88°/85°		75°		65°		55°		45°	
m	t	t	t	t	t	t	t	t	t	t	t
34	135,0*	166,0*	-	-	-	-	-	-	-	-	-
38	119,0*	161,0*	-	-	-	-	-	-	-	-	-
42	106,0*	171,0	-	-	-	-	-	-	-	168,0	-
46	94,5*	169,0	-	-	-	-	-	-	-	168,0	-
50	84,5*	165,0	-	-	-	-	-	-	-	168,0	-
54	75,5*	162,0	-	-	-	-	-	-	-	168,0	-
58	68,0*	158,0	-	-	-	-	-	-	-	168,0	-
62	61,0*	155,0	-	-	-	-	-	-	-	168,0	-
66	55,0*	151,0	-	-	-	-	-	-	-	167,0	-
70	49,9*	148,0	-	-	-	-	-	-	-	164,0	-
72	47,4*	146,0	170,0	-	-	-	-	-	-	162,5	-
74	45,0*	143,0	170,0	-	-	-	-	-	-	161,0	-
78	40,5*	139,0	170,0	-	-	-	-	-	-	159,0	-
82	36,5*	134,5	169,0	-	-	-	-	-	-	156,0	-
84	34,6*	132,0	169,0	-	-	-	-	-	-	155,0	-
86	24,1	125,5	168,0	-	-	-	-	-	-	154,0	-
88	22,5	119,0	166,0	-	-	-	-	-	-	150,0	-
90	-	-	164,0	-	-	-	-	-	-	149,0	-
94	-	-	155,0	-	-	-	-	-	-	146,0	-
98	-	-	143,0	148,0	-	-	-	-	-	143,0	-
102	-	-	132,0	140,0	-	-	-	-	-	134,0	-
106	-	-	119,0	133,0	-	-	-	-	-	124,0	-
110	-	-	-	126,0	-	-	-	-	-	115,0	-
114	-	-	-	120,0	-	-	-	-	-	106,0	-
118	-	-	-	114,0	-	-	-	-	-	98,0	-
120	-	-	-	111,0	-	-	-	-	-	94,0	-
122	-	-	-	-	92,0	-	-	-	-	90,0	-
126	-	-	-	-	87,5	-	-	-	-	83,0	-
130	-	-	-	-	83,5	-	-	-	-	75,5	-
134	-	-	-	-	80,0	-	-	-	-	66,5	-
138	-	-	-	-	-	-	-	-	-	58,0	-
142	-	-	-	-	-	-	-	-	-	52,0	49,8
146	-	-	-	-	-	-	-	-	-	49,4	41,6
150	-	-	-	-	-	-	-	-	-	33,5	33,5
154	-	-	-	-	-	-	-	-	-	28,7	28,7
158	-	-	-	-	-	-	-	-	-	23,7	23,7
38	110,0*	135,0*	-	-	-	-	-	-	-	-	-
42	97,5*	132,0*	-	-	-	-	-	-	-	-	-
46	86,5*	137,0	-	-	-	-	-	-	-	-	136,0
50	77,0*	136,0	-	-	-	-	-	-	-	-	136,0
54	68,5*	134,0	-	-	-	-	-	-	-	-	136,0
58	61,0*	131,0	-	-	-	-	-	-	-	-	136,0
62	54,5*	129,0	-	-	-	-	-	-	-	-	136,0
66	48,7*	126,0	-	-	-	-	-	-	-	-	136,0
70	43,5*	124,0	-	-	-	-	-	-	-	-	136,0
74	38,6*	121,0	-	-	-	-	-	-	-	-	133,0
78	34,2*	119,0	133,0	-	-	-	-	-	-	-	131,0
82	30,3*	116,0	133,0	-	-	-	-	-	-	-	128,0
86	26,6*	112,0	133,0	-	-	-	-	-	-	-	126,0
90	23,3*	108,5	133,0	-	-	-	-	-	-	-	123,0
94	20,2*	105,0	132,0	-	-	-	-	-	-	-	120,0
96	18,8*	103,0	132,0	-	-	-	-	-	-	-	119,0
98	-	97,2	132,0	-	-	-	-	-	-	-	118,0
100	-	91,5	131,0	-	-	-	-	-	-	-	115,5
102	-	-	130,0	-	-	-	-	-	-	-	114,0
106	-	-	120,0	115,0	-	-	-	-	-	-	111,0
110	-	-	111,0	111,0	-	-	-	-	-	-	109,0
114	-	-	103,0	114,0	-	-	-	-	-	-	106,0
118	-	-	92,0	109,0	-	-	-	-	-	-	99,0
122	-	-	-	104,0	-	-	-	-	-	-	91,0
126	-	-	-	99,0	-	-	-	-	-	-	84,0
130	-	-	-	94,5	78,0	-	-	-	-	-	77,0
132	-	-	-	92,5	76,0	-	-	-	-	-	74,0
134	-	-	-	-	74,5	-	-	-	-	-	71,0
138	-	-	-	-	70,5	-	-	-	-	-	64,0
142	-	-	-	-	67,5	-	-	-	-	-	56,0
146	-	-	-	-	64,5	-	-	-	-	-	48,4
150	-	-	-	-	-	-	-	-	-	-	40,8
152	-	-	-	-	-	-	-	-	-	-	37,1
154	-	-	-	-	-	-	-	-	-	-	33,5
158	-	-	-	-	-	-	-	-	-	-	26,2
162	-	-	-	-	-	-	-	-	-	-	20,0
166	-	-	-	-	-	-	-	-	-	-	15,9
170	-	-	-	-	-	-	-	-	-	-	10,6

0 t 100 t 180 t 240 t 340 t 440 t 540 t 640 t

6 m steps of luffing jib is standard · 6 m Stufung der Wippe ist Standard · Des paliers de 6 m sont de série pour la fléchette · Falcone standard con sezioni di 6 m · Incrementos de 6 m para plumín abatible son estándar · Lances de 6 m da lança auxiliar como padrão · 6 м шаг размера гуська является стандартом

* Main boom angle 88° · Hauptauslegerwinkel 88° · Jarret de flèche principale 88° · Inclinação braccio base 88° · Ángulo de pluma principal 88° · Ángulo da lança principal 88° · Угол подъема гл. стрелы 88°

Main boom angle 88°, 85°, 75°, 65°, 55° and 45°; capacities for intermediate boom positions are calculated by the crane control system IC-1 · Hauptauslegerwinkel 88°, 85°, 75°, 65°, 55° und 45°; Traglasten für Zwischenstellungen des Hauptauslegers werden von der Kransteuerung IC-1 berechnet

Jarret de flèche principale 88°, 85°, 75°, 65°, 55° et 45°; le système de commande de la grue IC-1 calcule les charges pour les positions intermédiaires de la flèche

Inclinazione braccio base 88°, 85°, 75°, 65°, 55° e 45°; capacità per posizioni intermedie del braccio sono calcolate dal sistema di controllo della gru IC-1

Ángulo de pluma principal 88°, 85°, 75°, 65°, 55° y 45° las capacidades para posiciones de pluma intermedias son calculadas por el sistema de control de grúa IC-1

Ángulos da lança principal 88°, 85°, 75°, 65°, 55° e 45°; as capacidades para posições da lança intermediária são calculadas pelo sistema de controle da grua IC-1

Грузоподъемность при углах подъема главной стрелы 88°, 85°, 75°, 65°, 55° и 45°, грузоподъемность в промежуточных положениях стрелы рассчитывается системой управления краном IC-1

295 t + 60 t								19-30 m		10,5 m		9.8 m/s		360°		ISO											
90 m + 108 m										96 m + 36 m																	
SWSL				SFSL				SWSL				SFSL															
0 t		0 t - 640 t						0 t		0 t - 640 t																	
88°/85°		88°/85°		75°		65°		55°		45°		88°/85°		88°/85°		75°		65°		55°		45°					
m	t	t	t	t	t	t	t	t	t	t	t	m	t	t	t	t	t	t	t	t	t	t	t	t	t	t	t
40	95,5*	108,0*	-	-	-	-	-	-	-	-	-	20	286,0*	342,0*	-	-	-	-	-	-	-	-	-	-	-	-	-
42	89,5*	108,0*	-	-	-	-	-	-	-	-	-	22	263,0*	333,0*	-	-	-	-	-	-	-	-	-	-	-	-	-
46	78,5*	106,0*	-	-	-	-	-	-	-	-	-	24	243,0*	323,0*	-	-	-	-	-	-	-	-	-	-	-	-	-
50	69,5*	110,0	-	-	-	-	-	-	-	-	-	26	226,0*	355,0	-	-	-	-	-	-	-	-	-	-	-	-	346,0
54	61,5*	109,0	-	-	-	-	-	-	-	-	-	28	210,0*	351,0	-	-	-	-	-	-	-	-	-	-	-	-	346,0
58	54,0*	107,0	-	-	-	-	-	-	-	-	-	30	197,0*	343,0	-	-	-	-	-	-	-	-	-	-	-	-	346,0
62	48,0*	105,0	-	-	-	-	-	-	-	-	-	34	174,0*	326,0	-	-	-	-	-	-	-	-	-	-	-	-	346,0
66	42,3*	104,0	-	-	-	-	-	-	-	-	-	38	155,0*	310,0	-	-	-	-	-	-	-	-	-	-	-	-	346,0
70	37,1*	102,0	-	-	-	-	-	-	-	-	-	40	147,0*	304,0	-	-	-	-	-	-	-	-	-	-	-	-	346,0
74	32,4*	100,0	-	-	-	-	-	-	-	-	-	42	123,0	299,0	-	-	-	-	-	-	-	-	-	-	-	-	346,0
78	28,2*	98,5	-	-	-	-	-	-	-	-	-	46	111,0	287,0	-	-	-	-	-	-	-	-	-	-	-	-	340,0
82	24,3*	96,7	-	-	-	-	-	-	-	-	-	48	-	-	361,0	-	-	-	-	-	-	-	-	-	-	-	334,0
84	22,4*	96,0	104,0	-	-	-	-	-	-	-	-	50	-	-	357,0	-	-	-	-	-	-	-	-	-	-	-	329,0
86	20,7*	95,0	104,0	-	-	-	-	-	-	-	-	54	-	-	347,0	-	-	-	-	-	-	-	-	-	-	-	313,0
88	19,1*	94,0	104,0	-	-	-	-	-	-	-	-	58	-	-	334,0	-	-	-	-	-	-	-	-	-	-	-	302,0
90	17,5*	91,7	104,0	-	-	-	-	-	-	-	-	62	-	-	318,0	-	-	-	-	-	-	-	-	-	-	-	291,0
94	14,4*	87,5	104,0	-	-	-	-	-	-	-	-	66	-	-	-	-	-	-	-	-	-	-	-	-	-	-	266,0
98	11,6*	83,2	104,0	-	-	-	-	-	-	-	-	69	-	-	-	251,0	-	-	-	-	-	-	-	-	-	-	248,0
100	10,3*	81,0	104,0	-	-	-	-	-	-	-	-	70	-	-	-	247,0	-	-	-	-	-	-	-	-	-	-	242,0
102	-	79,0	104,0	-	-	-	-	-	-	-	-	74	-	-	-	231,0	-	-	-	-	-	-	-	-	-	-	222,0
106	-	74,7	103,0	-	-	-	-	-	-	-	-	78	-	-	-	217,0	-	-	-	-	-	-	-	-	-	-	203,0
108	-	72,5	103,0	-	-	-	-	-	-	-	-	82	-	-	-	-	-	-	-	-	-	-	-	-	-	-	186,0
110	-	69,7	103,0	-	-	-	-	-	-	-	-	86	-	-	-	-	-	-	-	-	-	-	-	-	-	-	171,0
112	-	67,0	103,0	-	-	-	-	-	-	-	-	88	-	-	-	-	-	-	-	-	-	-	-	-	-	-	164,0
114	-	-	99,0	89,5	-	-	-	-	-	-	-	90	-	-	-	-	-	-	-	-	-	-	-	-	-	-	157,0
118	-	-	91,5	89,5	-	-	-	-	-	-	-	93	-	-	-	-	-	-	-	-	-	-	-	-	-	-	148,0
122	-	-	84,5	89,5	-	-	-	-	-	-	-	94	-	-	-	-	-	-	-	-	-	-	-	-	-	-	145,0
126	-	-	78,0	89,5	-	-	-	-	-	-	-	98	-	-	-	-	-	-	-	-	-	-	-	-	-	-	133,0
128	-	-	73,5	89,5	-	-	-	-	-	-	-	102	-	-	-	-	-	-	-	-	-	-	-	-	-	-	122,0
130	-	-	-	88,0	-	-	-	-	-	-	-	104	-	-	-	-	-	-	-	-	-	-	-	-	-	-	115,0
134	-	-	-	83,5	-	-	-	-	-	-	-	106	-	-	-	-	-	-	-	-	-	-	-	-	-	-	108,0
138	-	-	-	79,5	-	-	-	-	-	-	-	110	-	-	-	-	-	-	-	-	-	-	-	-	-	-	94,0
140	-	-	-	77,5	62,0	-	-	-	-	-	-	114	-	-	-	-	-	-	-	-	-	-	-	-	-	-	80,5
142	-	-	-	76,0	60,5	-	-	-	-	-	-	118	-	-	-	-	-	-	-	-	-	-	-	-	-	-	67,5
144	-	-	-	74,5	59,0	-	-	-	-	-	-	-	-	-	-	-	-	-	-	-	-	-	-	-	-	-	-
146	-	-	-	-	57,5	-	-	-	-	-	-	-	-	-	-	-	-	-	-	-	-	-	-	-	-	-	-
150	-	-	-	-	54,5	-	-	-	-	-	-	-	-	-	-	-	-	-	-	-	-	-	-	-	-	-	-
154	-	-	-	-	51,5	-	-	-	-	-	-	-	-	-	-	-	-	-	-	-	-	-	-	-	-	-	-
158	-	-	-	-	48,8	-	-	-	-	-	-	-	-	-	-	-	-	-	-	-	-	-	-	-	-	-	-
162	-	-	-	-	-	25,2	-	-	-	-	-	-	-	-	-	-	-	-	-	-	-	-	-	-	-	-	-
166	-	-	-	-	-	23,0	-	-	-	-	-	-	-	-	-	-	-	-	-	-	-	-	-	-	-	-	-
170	-	-	-	-	-	21,0	-	-	-	-	-	-	-	-	-	-	-	-	-	-	-	-	-	-	-	-	-

6 m steps of luffing jib is standard · 6 m Stufung der Wippe ist Standard · Des paliers de 6 m sont de série pour la fléchette · Falcone standard con sezioni di 6 m · Incrementos de 6 m para plumín abatible son estándar · Lancas de 6 m da lança auxiliar como padrão · 6 m шаг размера гуська является стандартом

* Main boom angle 88° · Hauptauslegerwinkel 88° · Jarret de flèche principale 88° · Inclinazione braccio base 88° · Ángulo de pluma principal 88° · Ángulo da lança principal 88° · Угол подъема гл. стрелы 88°

Main boom angle 88°, 85°, 75°, 65°, 55° and 45°; capacities for intermediate boom positions are calculated by the crane control system IC-1 · Hauptauslegerwinkel 88°, 85°, 75°, 65°, 55° und 45°; Traglasten für Zwischenstellungen des Hauptauslegers werden von der Kransteuerung IC-1 berechnet

Jarret de flèche principale 88°, 85°, 75°, 65°, 55° et 45°; le système de commande de la grue IC-1 calcule les charges pour les positions intermédiaires de la flèche

Inclinazione braccio base 88°, 85°, 75°, 65°, 55° e 45°; capacità per posizioni intermedie del braccio sono calcolate dal sistema di controllo della gru IC-1

Ángulo de pluma principal 88°, 85°, 75°, 65°, 55° y 45° las capacidades para posiciones de pluma intermedias son calculadas por el sistema de control de grúa IC-1

Ângulos da lança principal 88°, 85°, 75°, 65°, 55° e 45°; as capacidades para posições da lança intermediária são calculadas pelo sistema de controle da grua IC-1

Грузоподъемность при углах подъема главной стрелы 88°, 85°, 75°, 65°, 55° и 45°, грузоподъемность в промежуточных положениях стрелы рассчитывается системой управления краном IC-1

295 t + 60 t 19-30 m 10,5 m 9.8 m/s 360° ISO									
96 m + 48 m									
SWSL					SFSL				
0 t			0 t - 640 t						
88°/85°		88°/85°		75°		65°		55°	
88°/85°		88°/85°		75°		65°		55°	
m	t	t	t	t	t	t	t	t	
24	227,0*	277,0*	-	-	-	-	-	-	
26	211,0*	270,0*	-	-	-	-	-	-	
28	197,0*	263,0*	-	-	-	-	-	-	
30	184,0*	290,0	-	-	-	-	-	281,0	
34	162,0*	282,0	-	-	-	-	-	281,0	
38	144,0*	270,0	-	-	-	-	-	281,0	
42	129,0*	259,0	-	-	-	-	-	281,0	
46	117,0*	248,0	-	-	-	-	-	281,0	
50	106,0*	240,0	-	-	-	-	-	280,0	
52	101,0*	235,0	-	-	-	-	-	276,0	
54	83,5	231,0	292,0	-	-	-	-	272,0	
56	79,5	227,0	292,0	-	-	-	-	268,0	
58	-	-	291,0	-	-	-	-	264,0	
62	-	-	279,0	-	-	-	-	254,0	
66	-	-	272,0	-	-	-	-	245,0	
70	-	-	264,0	-	-	-	-	237,0	
74	-	-	245,0	-	-	-	-	225,0	
77	-	-	-	214,0	-	-	-	211,5	
78	-	-	-	211,0	-	-	-	207,0	
82	-	-	-	198,0	-	-	-	190,0	
86	-	-	-	187,0	-	-	-	174,0	
90	-	-	-	177,0	-	-	-	160,0	
94	-	-	-	-	-	-	-	147,0	
97	-	-	-	-	-	140,0	-	138,7	
98	-	-	-	-	-	139,0	-	136,0	
102	-	-	-	-	-	132,0	-	125,0	
104	-	-	-	-	-	129,0	-	120,0	
106	-	-	-	-	-	-	-	115,0	
110	-	-	-	-	-	-	-	106,0	
114	-	-	-	-	-	-	95,5	94,0	
117	-	-	-	-	-	-	92,0	85,0	
118	-	-	-	-	-	-	-	82,0	
122	-	-	-	-	-	-	-	70,5	
126	-	-	-	-	-	-	-	59,0	
130	-	-	-	-	-	-	-	51,0	

96 m + 60 m									
SWSL					SFSL				
0 t			0 t - 640 t						
88°/85°		88°/85°		75°		65°		55°	
88°/85°		88°/85°		75°		65°		55°	
m	t	t	t	t	t	t	t	t	
26	198,0*	229,0*	-	-	-	-	-	-	
28	185,0*	226,0*	-	-	-	-	-	-	
30	173,0*	222,0*	-	-	-	-	-	-	
34	152,0*	235,0	-	-	-	-	-	231,0	
38	135,0*	232,0	-	-	-	-	-	231,0	
42	121,0*	225,0	-	-	-	-	-	231,0	
46	109,0*	217,0	-	-	-	-	-	231,0	
50	98,5*	210,0	-	-	-	-	-	231,0	
54	89,5*	202,0	-	-	-	-	-	231,0	
58	81,5*	196,0	-	-	-	-	-	227,0	
60	78,0*	193,0	237,0	-	-	-	-	224,0	
62	74,5*	190,0	237,0	-	-	-	-	221,0	
64	71,5*	187,0	237,0	-	-	-	-	218,5	
66	56,5	184,0	235,0	-	-	-	-	216,0	
68	54,0	181,0	234,0	-	-	-	-	213,5	
70	-	-	231,0	-	-	-	-	211,0	
74	-	-	223,0	-	-	-	-	203,0	
78	-	-	219,0	-	-	-	-	198,0	
82	-	-	211,0	-	-	-	-	192,0	
84	-	-	202,0	-	-	-	-	186,5	
86	-	-	-	184,0	-	-	-	181,0	
90	-	-	-	174,0	-	-	-	166,0	
94	-	-	-	165,0	-	-	-	153,0	
98	-	-	-	156,0	-	-	-	141,0	
100	-	-	-	152,0	-	-	-	135,5	
102	-	-	-	-	-	-	-	130,0	
106	-	-	-	-	-	122,0	-	120,0	
110	-	-	-	-	-	116,0	-	111,0	
114	-	-	-	-	-	111,0	-	102,0	
116	-	-	-	-	-	108,0	-	98,2	
118	-	-	-	-	-	-	-	94,5	
122	-	-	-	-	-	-	-	84,5	
126	-	-	-	-	-	-	78,0	74,0	
128	-	-	-	-	-	-	76,0	68,7	
130	-	-	-	-	-	-	-	63,5	
134	-	-	-	-	-	-	-	53,5	
138	-	-	-	-	-	-	-	44,6	

6 m steps of luffing jib is standard · 6 m Stufung der Wippe ist Standard · Des paliers de 6 m sont de série pour la fléchette · Falcone standard con sezioni di 6 m · Incrementos de 6 m para plumín abatible son estándar · Lances de 6 m da lança auxiliar como padrão · 6 м шаг размера гуська является стандартом

* Main boom angle 88° · Hauptauslegerwinkel 88° · Jarret de flèche principale 88° · Inclinazione braccio base 88° · Ângulo de pluma principal 88° · Ângulo da lança principal 88° · Угол подъема гл. стрелы 88°

Main boom angle 88°, 85°, 75°, 65°, 55° and 45°; capacities for intermediate boom positions are calculated by the crane control system IC-1 · Hauptauslegerwinkel 88°, 85°, 75°, 65°, 55° und 45°; Traglasten für Zwischenstellungen des Hauptauslegers werden von der Kransteuerung IC-1 berechnet

Jarret de flèche principale 88°, 85°, 75°, 65°, 55° et 45°; le système de commande de la grue IC-1 calcule les charges pour les positions intermédiaires de la flèche

Inclinazione braccio base 88°, 85°, 75°, 65°, 55° e 45°; capacità per posizioni intermedie del braccio sono calcolate dal sistema di controllo della gru IC-1

Ângulo de pluma principal 88°, 85°, 75°, 65°, 55° y 45° las capacidades para posiciones de pluma intermedias son calculadas por el sistema de control de grúa IC-1

Ângulos da lança principal 88°, 85°, 75°, 65°, 55° e 45°; as capacidades para posições da lança intermediária são calculadas pelo sistema de controle da grua IC-1

Грузоподъемность при углах подъема главной стрелы 88°, 85°, 75°, 65°, 55° и 45°, грузоподъемность в промежуточных положениях стрелы рассчитывается системой управления краном IC-1

295 t + 60 t								19-30 m								10,5 m								9.8 m/s								360°								ISO							
96 m + 72 m								SWSL								SFSL								96 m + 84 m								SWSL								SFSL							
0 t				0 t - 640 t				0 t				0 t - 640 t				0 t				0 t - 640 t				0 t				0 t - 640 t																			
88°/85°		88°/85°		75°		65°		55°		45°		88°/85°		88°/85°		75°		65°		55°		45°		88°/85°		88°/85°		75°		65°		55°		45°													
m	t	t	t	t	t	t	t	m	t	t	t	t	t	t	t	t	m	t	t	t	t	t	m	t	t	t	t	t	t	t																	
30	162,0*	187,0*	-	-	-	-	-	34	130,0*	151,0*	-	-	-	-	-	-	38	115,0*	148,0*	-	-	-	-	-	-	-	-	-	-	-	-																
34	142,0*	182,0*	-	-	-	-	-	38	115,0*	148,0*	-	-	-	-	-	-	42	102,0*	144,0*	-	-	-	-	-	-	-	-	-	-	-	-																
38	126,0*	176,0*	-	-	-	-	-	42	102,0*	144,0*	-	-	-	-	-	-	44	96,0*	156,0*	-	-	-	-	-	-	-	-	-	-	-	-																
40	119,0*	192,0	-	-	-	-	189,0	44	96,0*	156,0*	-	-	-	-	-	-	46	91,0*	155,0	-	-	-	-	-	-	-	-	-	-	-	154,0																
42	112,0*	190,0	-	-	-	-	189,0	46	91,0*	155,0	-	-	-	-	-	-	50	81,0*	151,0	-	-	-	-	-	-	-	-	-	-	-	154,0																
46	101,0*	185,0	-	-	-	-	189,0	50	81,0*	151,0	-	-	-	-	-	-	54	72,5*	148,0	-	-	-	-	-	-	-	-	-	-	-	154,0																
50	91,0*	180,0	-	-	-	-	189,0	54	72,5*	148,0	-	-	-	-	-	-	58	65,0*	144,0	-	-	-	-	-	-	-	-	-	-	-	154,0																
54	82,0*	175,0	-	-	-	-	189,0	58	65,0*	144,0	-	-	-	-	-	-	62	58,5*	141,0	-	-	-	-	-	-	-	-	-	-	-	154,0																
58	74,5*	170,0	-	-	-	-	189,0	62	58,5*	141,0	-	-	-	-	-	-	66	52,5*	137,0	-	-	-	-	-	-	-	-	-	-	-	153,0																
62	67,5*	165,0	-	-	-	-	187,0	66	52,5*	137,0	-	-	-	-	-	-	70	47,5*	134,0	-	-	-	-	-	-	-	-	-	-	-	151,0																
66	61,5*	160,0	192,0	-	-	-	184,0	70	47,5*	134,0	-	-	-	-	-	-	72	45,1*	132,0	154,0	-	-	-	-	-	-	-	-	-	-	150,0																
70	56,0*	156,0	192,0	-	-	-	181,0	72	45,1*	132,0	154,0	-	-	-	-	-	74	42,8*	130,0	154,0	-	-	-	-	-	-	-	-	-	-	149,0																
74	51,0*	151,0	191,0	-	-	-	177,0	74	42,8*	130,0	154,0	-	-	-	-	-	78	38,4*	127,0	154,0	-	-	-	-	-	-	-	-	-	-	147,0																
78	36,8	146,0	189,0	-	-	-	174,0	78	38,4*	127,0	154,0	-	-	-	-	-	82	34,5*	123,0	154,0	-	-	-	-	-	-	-	-	-	-	144,0																
80	35,0	141,0	188,0	-	-	-	170,0	82	34,5*	123,0	154,0	-	-	-	-	-	84	32,7*	121,0	153,0	-	-	-	-	-	-	-	-	-	-	143,0																
82	-	-	186,0	-	-	-	168,0	84	32,7*	121,0	153,0	-	-	-	-	-	86	21,4	119,0	152,0	-	-	-	-	-	-	-	-	-	-	142,0																
86	-	-	181,0	-	-	-	164,0	86	21,4	119,0	152,0	-	-	-	-	-	90	18,4	110,5	151,0	-	-	-	-	-	-	-	-	-	-	137,0																
90	-	-	178,0	-	-	-	161,0	90	18,4	110,5	151,0	-	-	-	-	-	92	17,0	104,0	150,0	-	-	-	-	-	-	-	-	-	-	136,0																
92	-	-	173,0	164,0	-	-	158,5	92	17,0	104,0	150,0	-	-	-	-	-	94	-	-	147,0	-	-	-	-	-	-	-	-	-	-	135,0																
94	-	-	166,0	160,0	-	-	156,0	94	-	-	147,0	-	-	-	-	-	98	-	-	145,0	-	-	-	-	-	-	-	-	-	-	132,0																
96	-	-	156,0	155,0	-	-	150,0	98	-	-	145,0	-	-	-	-	-	100	-	-	141,0	127,0	-	-	-	-	-	-	-	-	131,0																	
98	-	-	-	151,0	-	-	144,0	100	-	-	141,0	127,0	-	-	-	-	102	-	-	136,0	127,0	-	-	-	-	-	-	-	-	130,0																	
102	-	-	-	143,0	-	-	133,0	102	-	-	136,0	127,0	-	-	-	-	106	-	-	125,0	126,0	-	-	-	-	-	-	-	-	120,0																	
106	-	-	-	136,0	-	-	122,0	106	-	-	125,0	126,0	-	-	-	-	108	-	-	117,0	123,0	-	-	-	-	-	-	-	-	115,0																	
110	-	-	-	130,0	-	-	113,0	108	-	-	117,0	123,0	-	-	-	-	110	-	-	-	120,0	-	-	-	-	-	-	-	-	110,0																	
112	-	-	-	127,0	-	-	108,5	110	-	-	-	120,0	-	-	-	-	114	-	-	-	114,0	-	-	-	-	-	-	-	-	102,0																	
114	-	-	-	-	-	-	104,0	114	-	-	-	114,0	-	-	-	-	118	-	-	-	109,0	-	-	-	-	-	-	-	-	93,5																	
116	-	-	-	-	-	102,0	100,2	118	-	-	-	109,0	-	-	-	-	122	-	-	-	104,0	-	-	-	-	-	-	-	-	86,0																	
118	-	-	-	-	-	100,0	96,5	122	-	-	-	104,0	-	-	-	-	124	-	-	-	101,0	-	-	-	-	-	-	-	-	82,5																	
122	-	-	-	-	-	95,0	88,5	124	-	-	-	101,0	-	-	-	-	126	-	-	-	-	81,0	-	-	-	-	-	-	-	79,0																	
126	-	-	-	-	-	91,0	81,5	126	-	-	-	-	81,0	-	-	-	130	-	-	-	-	77,0	-	-	-	-	-	-	-	72,0																	
130	-	-	-	-	-	-	72,5	130	-	-	-	-	77,0	-	-	-	134	-	-	-	-	73,5	-	-	-	-	-	-	-	65,5																	
134	-	-	-	-	-	-	63,5	134	-	-	-	-	73,5	-	-	-	138	-	-	-	-	70,5	-	-	-	-	-	-	-	57,0																	
136	-	-	-	-	-	62,0	59,0	138	-	-	-	-	70,5	-	-	-	142	-	-	-	-	-	-	-	-	-	-	-	-	49,2																	
138	-	-	-	-	-	60,0	54,5	142	-	-	-	-	-	-	-	-	146	-	-	-	-	-	-	-	-	-	-	-	-	41,3																	
140	-	-	-	-	-	58,5	50,1	146	-	-	-	-	-	-	-	-	150	-	-	-	-	-	-	-	-	-	-	-	-	33,6																	
142	-	-	-	-	-	-	45,8	150	-	-	-	-	-	-	-	-	154	-	-	-	-	-	-	-	-	-	-	-	-	26,0																	
146	-	-	-	-	-	-	37,2	154	-	-	-	-	-	-	-	-	158	-	-	-	-	-	-	-	-	-	-	-	-	19,1																	
150	-	-	-	-	-	-	31,7	158	-	-	-	-	-	-	-	-	162	-	-	-	-	-	-	-	-	-	-	-	-	14,9																	

0 t 100 t 180 t 240 t 340 t 440 t 540 t 640 t

6 m steps of luffing jib is standard · 6 m Stufung der Wippe ist Standard · Des paliers de 6 m sont de série pour la fléchette · Falcone standard con sezioni di 6 m · Incrementos de 6 m para plumín abatible son estándar · Lances de 6 m da lança auxiliar como padrão · 6 м шаг размера гуська является стандартом

* Main boom angle 88° · Hauptauslegerwinkel 88° · Jarret de flèche principale 88° · Inclinazione braccio base 88° · Ángulo de pluma principal 88° · Ángulo da lança principal 88° · Угол подъема гл. стрелы 88°

Main boom angle 88°, 85°, 75°, 65°, 55° and 45°; capacities for intermediate boom positions are calculated by the crane control system IC-1 · Hauptauslegerwinkel 88°, 85°, 75°, 65°, 55° und 45°; Traglasten für Zwischenstellungen des Hauptauslegers werden von der Kransteuerung IC-1 berechnet

Jarret de flèche principale 88°, 85°, 75°, 65°, 55° et 45°; le système de commande de la grue IC-1 calcule les charges pour les positions intermédiaires de la flèche

Inclinazione braccio base 88°, 85°, 75°, 65°, 55° e 45°, capacità per posizioni intermedie del braccio sono calcolate dal sistema di controllo della gru IC-1

Ángulo de pluma principal 88°, 85°, 75°, 65°, 55° y 45° las capacidades para posiciones de pluma intermedias son calculadas por el sistema de control de grúa IC-1

Ángulos da lança principal 88°, 85°, 75°, 65°, 55° e 45°; as capacidades para posições da lança intermediária são calculadas pelo sistema de controle da grua IC-1

Грузоподъемность при углах подъема главной стрелы 88°, 85°, 75°, 65°, 55° и 45°, грузоподъемность в промежуточных положениях стрелы рассчитывается системой управления краном IC-1

295 t + 60 t 19-30 m 10,5 m 9.8 m/s 360° ISO								
96 m + 96 m								
SWSL SFSL								
0 t 0 t - 640 t								
88°/85° 88°/85° 75° 65° 55° 45°								
m	t	t	t	t	t	t	t	t
38	106,0*	124,0*	-	-	-	-	-	-
42	93,5*	121,0*	-	-	-	-	-	-
46	83,0*	118,0*	-	-	-	-	-	-
48	78,0*	125,0*	-	-	-	-	-	124,0
50	73,5*	125,0*	-	-	-	-	-	124,0
54	65,5*	123,0	-	-	-	-	-	124,0
58	58,0*	120,0	-	-	-	-	-	124,0
62	52,0*	117,0	-	-	-	-	-	124,0
66	46,2*	115,0	-	-	-	-	-	124,0
70	41,1*	113,0	-	-	-	-	-	124,0
74	36,4*	110,0	-	-	-	-	-	123,0
78	32,2*	108,0	121,0	-	-	-	-	121,0
82	28,3*	105,5	121,0	-	-	-	-	118,0
86	24,8*	102,5	121,0	-	-	-	-	116,0
90	21,5*	99,5	121,0	-	-	-	-	114,0
92	20,0*	98,0	121,0	-	-	-	-	113,0
94	18,5*	96,5	120,0	-	-	-	-	112,0
96	17,1*	95,0	120,0	-	-	-	-	110,5
98	-	93,5	119,0	-	-	-	-	109,0
100	-	92,0	119,0	-	-	-	-	107,5
102	-	-	118,0	-	-	-	-	106,0
106	-	-	118,0	-	-	-	-	103,0
108	-	-	117,0	105,0	-	-	-	102,0
110	-	-	114,0	105,0	-	-	-	101,0
114	-	-	106,0	105,0	-	-	-	98,5
118	-	-	96,5	104,0	-	-	-	95,0
120	-	-	90,5	101,0	-	-	-	91,0
122	-	-	-	99,0	-	-	-	87,0
126	-	-	-	94,0	-	-	-	80,0
130	-	-	-	89,5	-	-	-	73,0
134	-	-	-	85,5	68,0	-	-	66,5
138	-	-	-	-	64,5	-	-	60,5
142	-	-	-	-	61,5	-	-	54,5
146	-	-	-	-	58,5	-	-	47,2
150	-	-	-	-	55,5	-	-	39,9
154	-	-	-	-	-	-	-	32,8
156	-	-	-	-	-	-	31,1	29,3
158	-	-	-	-	-	-	29,9	25,8
162	-	-	-	-	-	-	27,6	19,0
166	-	-	-	-	-	-	-	12,3

96 m + 108 m								
SWSL SFSL								
0 t 0 t - 640 t								
88°/85° 88°/85° 75° 65° 55° 45°								
m	t	t	t	t	t	t	t	t
42	85,5*	99,0*	-	-	-	-	-	-
46	75,0*	97,0*	-	-	-	-	-	-
50	66,0*	95,0*	-	-	-	-	-	-
52	62,2*	100,0	-	-	-	-	-	-
54	58,5*	100,0	-	-	-	-	-	100,0
58	51,5*	98,5	-	-	-	-	-	100,0
62	45,4*	97,0	-	-	-	-	-	99,5
66	39,8*	95,0	-	-	-	-	-	99,0
70	34,7*	93,0	-	-	-	-	-	98,5
74	30,2*	91,5	-	-	-	-	-	98,0
78	26,1*	89,5	-	-	-	-	-	97,5
82	22,3*	87,7	-	-	-	-	-	96,0
84	20,5*	87,0	95,0	-	-	-	-	95,2
86	18,8*	86,0	95,0	-	-	-	-	94,5
90	15,6*	83,5	95,0	-	-	-	-	93,0
94	12,7*	80,5	95,0	-	-	-	-	91,5
96	11,3*	79,0	95,0	-	-	-	-	90,7
98	-	77,2	95,0	-	-	-	-	90,0
102	-	74,0	94,5	-	-	-	-	88,5
106	-	71,0	94,5	-	-	-	-	87,0
108	-	69,5	94,0	-	-	-	-	86,2
110	-	67,7	94,0	-	-	-	-	85,5
112	-	66,0	94,0	-	-	-	-	83,0
114	-	-	93,5	-	-	-	-	82,0
116	-	-	92,5	81,5	-	-	-	81,2
118	-	-	91,0	81,5	-	-	-	80,5
122	-	-	87,0	81,5	-	-	-	79,0
126	-	-	80,5	81,5	-	-	-	77,5
130	-	-	72,0	81,5	-	-	-	72,0
134	-	-	-	79,0	-	-	-	65,5
138	-	-	-	75,0	-	-	-	59,5
142	-	-	-	71,5	-	-	-	54,0
144	-	-	-	69,5	53,5	-	-	51,6
146	-	-	-	68,0	52,0	-	-	49,2
150	-	-	-	-	49,8	-	-	42,3
154	-	-	-	-	46,8	-	-	35,6
158	-	-	-	-	43,9	-	-	29,0
160	-	-	-	-	42,6	-	-	25,8
162	-	-	-	-	-	-	-	22,7
166	-	-	-	-	-	-	17,8	16,5
170	-	-	-	-	-	-	15,8	10,5
174	-	-	-	-	-	-	14,0	-

0 t 100 t 180 t 240 t 340 t 440 t 540 t 640 t

6 m steps of luffing jib is standard · 6 m Stufung der Wippe ist Standard · Des paliers de 6 m sont de série pour la fléchette · Falcone standard con sezioni di 6 m · Incrementos de 6 m para plumín abatible son estándar · Lances de 6 m da lança auxiliar como padrão · 6 м шаг размера гуска является стандартом

* Main boom angle 88° · Hauptauslegerwinkel 88° · Jarret de flèche principale 88° · Inclinazione braccio base 88° · Ángulo de pluma principal 88° · Ángulo da lança principal 88° · Угол подъема гл. стрелы 88°

Main boom angle 88°, 85°, 75°, 65°, 55° and 45°; capacities for intermediate boom positions are calculated by the crane control system IC-1 Hauptauslegerwinkel 88°, 85°, 75°, 65°, 55° und 45°; Traglasten für Zwischenstellungen des Hauptauslegers werden von der Kransteuerung IC-1 berechnet

Jarret de flèche principale 88°, 85°, 75°, 65°, 55° et 45°; le système de commande de la grue IC-1 calcule les charges pour les positions intermédiaires de la flèche

Inclinazione braccio base 88°, 85°, 75°, 65°, 55° e 45°; capacità per posizioni intermedie del braccio sono calcolate dal sistema di controllo della gru IC-1

Ángulo de pluma principal 88°, 85°, 75°, 65°, 55° y 45° las capacidades para posiciones de pluma intermedias son calculadas por el sistema de control de grúa IC-1

Ángulos da lança principal 88°, 85°, 75°, 65°, 55° e 45°; as capacidades para posições da lança intermediária são calculadas pelo sistema de controle da grua IC-1

Грузоподъемность при углах подъема главной стрелы 88°, 85°, 75°, 65°, 55° и 45°, грузоподъемность в промежуточных положениях стрелы рассчитывается системой управления краном IC-1

295 t + 60 t 19-30 m 10,5 m 9.8 m/s 360° ISO								
102 m + 36 m								
SWSL					SFSL			
0 t		0 t - 640 t						
	88°/85°	88°/85°	75°	65°	55°	45°		
m	t	t	t	t	t	t	t	t
20	276,0*	312,0*	-	-	-	-	-	-
22	254,0*	304,0*	-	-	-	-	-	-
24	235,0*	295,0*	-	-	-	-	-	-
26	218,0*	287,0*	-	-	-	-	-	-
28	203,0*	321,0	-	-	-	-	314,0	-
30	190,0*	314,0	-	-	-	-	314,0	-
34	168,0*	298,0	-	-	-	-	314,0	-
38	150,0*	284,0	-	-	-	-	314,0	-
40	143,0*	279,0	-	-	-	-	314,0	-
42	118,0	273,0	-	-	-	-	314,0	-
46	106,0	263,0	-	-	-	-	312,0	-
50	-	-	322,0	-	-	-	303,0	-
54	-	-	316,0	-	-	-	293,0	-
58	-	-	303,0	-	-	-	280,0	-
62	-	-	294,0	-	-	-	271,0	-
64	-	-	290,0	-	-	-	266,5	-
66	-	-	-	-	-	-	262,0	-
70	-	-	-	-	-	-	238,0	-
72	-	-	-	231,0	-	-	227,5	-
74	-	-	-	223,0	-	-	217,0	-
78	-	-	-	210,0	-	-	198,0	-
80	-	-	-	203,0	-	-	190,0	-
82	-	-	-	-	-	-	182,0	-
86	-	-	-	-	-	-	166,0	-
90	-	-	-	-	-	-	153,0	-
91	-	-	-	-	151,0	-	149,7	-
94	-	-	-	-	145,0	-	140,0	-
96	-	-	-	-	142,0	-	134,5	-
98	-	-	-	-	-	-	129,0	-
102	-	-	-	-	-	-	118,0	-
106	-	-	-	-	-	-	108,0	-
108	-	-	-	-	-	104,0	101,7	-
110	-	-	-	-	-	101,0	95,5	-
114	-	-	-	-	-	-	83,0	-
118	-	-	-	-	-	-	70,5	-
122	-	-	-	-	-	-	58,5	-

102 m + 48 m								
SWSL					SFSL			
0 t		0 t - 640 t						
	88°/85°	88°/85°	75°	65°	55°	45°		
m	t	t	t	t	t	t	t	t
24	219,0*	253,0*	-	-	-	-	-	-
26	204,0*	247,0*	-	-	-	-	-	-
28	190,0*	241,0*	-	-	-	-	-	-
30	178,0*	235,0*	-	-	-	-	-	-
32	167,0*	262,0	-	-	-	-	-	256,0
34	157,0*	257,0	-	-	-	-	-	256,0
38	139,0*	247,0	-	-	-	-	-	256,0
42	125,0*	237,0	-	-	-	-	-	256,0
46	113,0*	227,0	-	-	-	-	-	256,0
50	102,0*	219,0	-	-	-	-	-	256,0
52	98,0*	215,0	-	-	-	-	-	253,0
54	79,0	211,0	-	-	-	-	-	250,0
56	75,5	208,0	262,0	-	-	-	-	247,0
58	72,0	204,0	262,0	-	-	-	-	244,0
62	-	-	258,0	-	-	-	-	237,0
66	-	-	245,0	-	-	-	-	227,0
70	-	-	239,0	-	-	-	-	221,0
74	-	-	234,0	-	-	-	-	214,0
76	-	-	231,0	-	-	-	-	208,0
78	-	-	-	-	-	-	-	202,0
79	-	-	-	-	200,0	-	-	197,7
82	-	-	-	-	191,0	-	-	185,0
86	-	-	-	-	180,0	-	-	170,0
90	-	-	-	-	170,0	-	-	156,0
92	-	-	-	-	166,0	-	-	149,5
94	-	-	-	-	-	-	-	143,0
98	-	-	-	-	-	-	-	131,0
100	-	-	-	-	-	127,0	-	126,0
102	-	-	-	-	-	124,0	-	121,0
106	-	-	-	-	-	118,0	-	111,0
108	-	-	-	-	-	115,0	-	106,5
110	-	-	-	-	-	-	-	102,0
114	-	-	-	-	-	-	-	93,5
118	-	-	-	-	-	-	-	82,5
119	-	-	-	-	-	-	83,0	79,7
120	-	-	-	-	-	-	81,5	77,0
122	-	-	-	-	-	-	-	71,5
126	-	-	-	-	-	-	-	61,0
130	-	-	-	-	-	-	-	50,5
134	-	-	-	-	-	-	-	42,7

0 t 100 t 180 t 240 t 340 t 440 t 540 t 640 t

6 m steps of luffing jib is standard · 6 m Stufung der Wippe ist Standard · Des paliers de 6 m sont de série pour la fléchette · Falcone standard con sezioni di 6 m · Incrementos de 6 m para plumín abatible son estándar · Lances de 6 m da lança auxiliar como padrão · 6 м шаг размера гуська является стандартом

* Main boom angle 88° · Hauptauslegerwinkel 88° · Jarret de flèche principale 88° · Inclinazione braccio base 88° · Ângulo de pluma principal 88° · Ângulo da lança principal 88° · Угол подъема гл. стрелы 88°

Main boom angle 88°, 85°, 75°, 65°, 55° and 45°; capacities for intermediate boom positions are calculated by the crane control system IC-1 · Hauptauslegerwinkel 88°, 85°, 75°, 65°, 55° und 45°; Traglasten für Zwischenstellungen des Hauptauslegers werden von der Kransteuerung IC-1 berechnet

Jarret de flèche principale 88°, 85°, 75°, 65°, 55° et 45°; le système de commande de la grue IC-1 calcule les charges pour les positions intermédiaires de la flèche

Inclinazione braccio base 88°, 85°, 75°, 65°, 55° e 45°, capacità per posizioni intermedie del braccio sono calcolate dal sistema di controllo della gru IC-1

Ângulo de pluma principal 88°, 85°, 75°, 65°, 55° y 45° las capacidades para posiciones de pluma intermedias son calculadas por el sistema de control de grúa IC-1

Ângulos da lança principal 88°, 85°, 75°, 65°, 55° e 45°; as capacidades para posições da lança intermediária são calculadas pelo sistema de controle da grua IC-1

Грузоподъемность при углах подъема главной стрелы 88°, 85°, 75°, 65°, 55° и 45°, грузоподъемность в промежуточных положениях стрелы рассчитывается системой управления краном IC-1

295 t + 60 t								19-30 m								10,5 m								9.8 m/s								360°								ISO							
102 m + 60 m								SWSL								SFSL								102 m + 72 m								SWSL								SFSL							
0 t								0 t - 640 t								0 t								0 t - 640 t								0 t								0 t - 640 t							
88°/85°								88°/85°								75°								65°								55°								45°							
m	t	t	t	t	t	t	t	m	t	t	t	t	t	t	t	m	t	t	t	t	t	t	t	m	t	t	t	t	t	t	t	m	t	t	t	t	t	t	t								
28	178,0*	207,0*	-	-	-	-	-	30	156,0*	171,0*	-	-	-	-	-	34	137,0*	167,0*	-	-	-	-	-	-	-	-	38	121,0*	160,0*	-	-	-	-	-													
30	167,0*	203,0*	-	-	-	-	-	34	137,0*	167,0*	-	-	-	-	-	38	121,0*	160,0*	-	-	-	-	-	-	-	-	40	114,0*	176,0	-	-	-	-	-													
34	147,0*	194,0*	-	-	-	-	-	40	114,0*	176,0	-	-	-	-	-	42	108,0*	174,0	-	-	-	-	-	-	-	-	46	97,0*	169,0	-	-	-	-	-													
36	138,0*	215,0	-	-	-	-	211,0	42	108,0*	174,0	-	-	-	-	-	46	97,0*	169,0	-	-	-	-	-	-	-	50	87,5*	164,0	-	-	-	-	-														
38	130,0*	212,0	-	-	-	-	211,0	46	97,0*	169,0	-	-	-	-	-	50	87,5*	164,0	-	-	-	-	-	-	-	54	79,0*	159,0	-	-	-	-	-														
42	117,0*	205,0	-	-	-	-	211,0	50	87,5*	164,0	-	-	-	-	-	54	79,0*	159,0	-	-	-	-	-	-	-	58	71,5*	154,0	-	-	-	-	-														
46	105,0*	198,0	-	-	-	-	211,0	54	79,0*	159,0	-	-	-	-	-	58	71,5*	154,0	-	-	-	-	-	-	-	62	65,0*	150,0	-	-	-	-	-														
50	95,0*	191,0	-	-	-	-	211,0	62	65,0*	150,0	-	-	-	-	-	66	59,0*	145,0	-	-	-	-	-	-	-	66	59,0*	145,0	-	-	-	-	-														
54	86,0*	184,0	-	-	-	-	211,0	66	59,0*	145,0	-	-	-	-	-	68	56,0*	143,0	173,0	-	-	-	-	-	-	70	53,5*	141,0	173,0	-	-	-	-														
58	78,5*	178,0	-	-	-	-	208,0	70	53,5*	141,0	173,0	-	-	-	-	74	49,2*	137,0	172,0	-	-	-	-	-	-	74	49,2*	137,0	172,0	-	-	-	-														
62	71,5*	173,0	213,0	-	-	-	204,0	74	49,2*	137,0	172,0	-	-	-	-	78	33,9	133,0	171,0	-	-	-	-	-	-	78	33,9	133,0	171,0	-	-	-	-														
64	68,5*	170,0	213,0	-	-	-	202,0	80	32,1	131,0	169,0	-	-	-	-	82	-	168,0	-	-	-	-	-	-	-	80	32,1	131,0	169,0	-	-	-	-														
66	53,5	167,0	213,0	-	-	-	200,0	82	-	168,0	-	-	-	-	-	86	-	166,0	-	-	-	-	-	-	-	82	-	168,0	-	-	-	-	-														
68	51,0	165,0	212,0	-	-	-	197,5	86	-	166,0	-	-	-	-	-	90	-	161,0	-	-	-	-	-	-	-	86	-	166,0	-	-	-	-	-														
70	-	-	210,0	-	-	-	195,0	90	-	161,0	-	-	-	-	-	94	-	157,0	-	-	-	-	-	-	-	90	-	161,0	-	-	-	-	-														
74	-	-	206,0	-	-	-	191,0	94	-	157,0	-	-	-	-	-	96	-	156,0	149,0	-	-	-	-	-	-	94	-	157,0	-	-	-	-	-														
78	-	-	198,0	-	-	-	183,0	96	-	156,0	149,0	-	-	-	-	98	-	154,0	145,0	-	-	-	-	-	-	96	-	156,0	149,0	-	-	-	-														
82	-	-	194,0	-	-	-	179,0	98	-	154,0	145,0	-	-	-	-	102	-	-	138,0	-	-	-	-	-	-	98	-	154,0	145,0	-	-	-	-														
86	-	-	189,0	-	-	-	174,0	102	-	-	138,0	-	-	-	-	106	-	-	131,0	-	-	-	-	-	-	102	-	-	138,0	-	-	-	-														
88	-	-	-	173,0	-	-	168,0	106	-	-	131,0	-	-	-	-	110	-	-	124,0	-	-	-	-	-	-	106	-	-	131,0	-	-	-	-														
90	-	-	-	168,0	-	-	162,0	110	-	-	124,0	-	-	-	-	114	-	-	118,0	-	-	-	-	-	-	110	-	-	124,0	-	-	-	-														
94	-	-	-	159,0	-	-	149,0	114	-	-	118,0	-	-	-	-	118	-	-	-	-	-	-	-	-	-	114	-	-	118,0	-	-	-	-														
98	-	-	-	150,0	-	-	137,0	118	-	-	-	-	-	-	-	120	-	-	-	-	-	91,0	-	-	-	118	-	-	-	-	-	-	-														
102	-	-	-	143,0	-	-	127,0	122	-	-	-	-	-	-	-	122	-	-	-	-	-	88,5	-	-	-	122	-	-	-	-	-	-	-														
104	-	-	-	139,0	-	-	121,5	126	-	-	-	-	-	-	-	126	-	-	-	-	-	84,5	-	-	-	126	-	-	-	-	-	-	-														
106	-	-	-	-	-	-	116,0	130	-	-	-	-	-	-	-	130	-	-	-	-	-	81,0	-	-	-	130	-	-	-	-	-	-	-														
110	-	-	-	-	-	109,0	107,0	134	-	-	-	-	-	-	-	134	-	-	-	-	-	-	-	-	134	-	-	-	-	-	-	-															
114	-	-	-	-	-	104,0	98,5	138	-	-	-	-	-	-	-	138	-	-	-	-	-	-	-	-	138	-	-	-	-	-	-	-															
118	-	-	-	-	-	99,0	90,5	142	-	-	-	-	-	-	-	142	-	-	-	-	-	-	-	-	142	-	-	-	-	-	-	-															
122	-	-	-	-	-	-	83,0	146	-	-	-	-	-	-	-	146	-	-	-	-	-	-	-	-	146	-	-	-	-	-	-	-															
126	-	-	-	-	-	-	74,0	150	-	-	-	-	-	-	-	150	-	-	-	-	-	-	-	-	150	-	-	-	-	-	-	-															
130	-	-	-	-	-	-	68,0	154	-	-	-	-	-	-	-	154	-	-	-	-	-	-	-	-	154	-	-	-	-	-	-	-															
132	-	-	-	-	-	-	66,0	158	-	-	-	-	-	-	-	158	-	-	-	-	-	-	-	-	158	-	-	-	-	-	-	-															
134	-	-	-	-	-	-	54,5	162	-	-	-	-	-	-	-	162	-	-	-	-	-	-	-	-	162	-	-	-	-	-	-	-															
138	-	-	-	-	-	-	45,5	166	-	-	-	-	-	-	-	166	-	-	-	-	-	-	-	-	166	-	-	-	-	-	-	-															
142	-	-	-	-	-	-	36,4	170	-	-	-	-	-	-	-	170	-	-	-	-	-	-	-	-	170	-	-	-	-	-	-	-															
146	-	-	-	-	-	-	31,1	174	-	-	-	-	-	-	-	174	-	-	-	-	-	-	-	-	174	-	-	-	-	-	-	-															

0 t 100 t 180 t 240 t 340 t 440 t 540 t 640 t

6 m steps of luffing jib is standard · 6 m Stufung der Wippe ist Standard · Des paliers de 6 m sont de série pour la fléchette · Falcone standard con sezioni di 6 m · Incrementos de 6 m para plumín abatible son estándar · Lances de 6 m da lança auxiliar como padrão · 6 м шаг размера гуська является стандартом

* Main boom angle 88° · Hauptauslegerwinkel 88° · Jarret de flèche principale 88° · Inclinazione braccio base 88° · Ángulo de pluma principal 88° · Ángulo da lança principal 88° · Угол подъема гл. стрелы 88°

Main boom angle 88°, 85°, 75°, 65°, 55° and 45°; capacities for intermediate boom positions are calculated by the crane control system IC-1 · Hauptauslegerwinkel 88°, 85°, 75°, 65°, 55° und 45°; Traglasten für Zwischenstellungen des Hauptauslegers werden von der Kransteuerung IC-1 berechnet

Jarret de flèche principale 88°, 85°, 75°, 65°, 55° et 45°; le système de commande de la grue IC-1 calcule les charges pour les positions intermédiaires de la flèche

Inclinazione braccio base 88°, 85°, 75°, 65°, 55° e 45°; capacità per posizioni intermedie del braccio sono calcolate dal sistema di controllo della gru IC-1

Ángulo de pluma principal 88°, 85°, 75°, 65°, 55° y 45° las capacidades para posiciones de pluma intermedias son calculadas por el sistema de control de grúa IC-1

Ángulos da lança principal 88°, 85°, 75°, 65°, 55° e 45°; as capacidades para posições da lança intermediária são calculadas pelo sistema de controle da grua IC-1

Грузоподъемность при углах подъема главной стрелы 88°, 85°, 75°, 65°, 55° и 45°, грузоподъемность в промежуточных положениях стрелы рассчитывается системой управления краном IC-1

295 t + 60 t 19-30 m 10,5 m 9.8 m/s 360° ISO								102 m + 84 m								102 m + 96 m								
SWSL				SFSL				SWSL				SFSL				SWSL				SFSL				
0 t				0 t - 640 t				0 t				0 t - 640 t				0 t				0 t - 640 t				
88°/85°		88°/85°		75°		65°		55°		45°		88°/85°		88°/85°		75°		65°		55°		45°		
m	t	t	t	t	t	t	t	m	t	t	t	t	t	t	t	t	m	t	t	t	t	t	t	
34	125,0*	139,0*	-	-	-	-	-	38	101,0*	113,0*	-	-	-	-	-	-	42	89,5*	111,0*	-	-	-	-	-
38	110,0*	136,0*	-	-	-	-	-	42	89,5*	111,0*	-	-	-	-	-	-	46	79,0*	108,0*	-	-	-	-	-
42	98,0*	132,0*	-	-	-	-	-	46	79,0*	108,0*	-	-	-	-	-	-	48	74,5*	115,0	-	-	-	-	-
44	92,5*	142,0	-	-	-	-	140,0	48	74,5*	115,0	-	-	-	-	-	-	50	70,0*	114,0	-	-	-	-	-
46	87,0*	141,0	-	-	-	-	140,0	50	70,0*	114,0	-	-	-	-	-	-	54	62,5*	112,0	-	-	-	-	114,0
50	78,0*	138,0	-	-	-	-	140,0	54	62,5*	112,0	-	-	-	-	-	-	58	55,5*	109,0	-	-	-	-	114,0
54	69,5*	134,0	-	-	-	-	140,0	58	55,5*	109,0	-	-	-	-	-	-	62	49,3*	107,0	-	-	-	-	113,0
58	62,5*	131,0	-	-	-	-	140,0	62	49,3*	107,0	-	-	-	-	-	-	66	43,8*	104,0	-	-	-	-	113,0
62	56,0*	127,0	-	-	-	-	140,0	66	43,8*	104,0	-	-	-	-	-	-	70	38,8*	102,0	-	-	-	-	113,0
66	50,0*	124,0	-	-	-	-	140,0	70	38,8*	102,0	-	-	-	-	-	-	74	34,2*	99,5	-	-	-	-	112,0
70	45,3*	120,0	-	-	-	-	138,0	74	34,2*	99,5	-	-	-	-	-	-	78	30,1*	97,0	-	-	-	-	110,0
74	40,6*	117,0	137,0	-	-	-	135,0	78	30,1*	97,0	-	-	-	-	-	-	80	28,2*	96,0	109,0	-	-	-	109,0
78	36,3*	114,0	137,0	-	-	-	132,0	80	28,2*	96,0	109,0	-	-	-	-	-	82	26,4*	94,7	109,0	-	-	-	108,0
82	32,5*	111,5	136,0	-	-	-	129,0	82	26,4*	94,7	109,0	-	-	-	-	-	86	22,9*	92,2	109,0	-	-	-	106,0
84	30,7*	110,0	136,0	-	-	-	127,5	86	22,9*	92,2	109,0	-	-	-	-	-	88	21,3*	91,0	109,0	-	-	-	105,0
86	18,9	108,5	135,0	-	-	-	126,0	88	21,3*	91,0	109,0	-	-	-	-	-	90	19,7*	89,7	109,0	-	-	-	104,0
90	16,0	105,5	133,0	-	-	-	124,0	90	19,7*	89,7	109,0	-	-	-	-	-	94	16,8*	87,2	108,0	-	-	-	102,0
92	14,6	104,0	132,0	-	-	-	122,5	94	16,8*	87,2	108,0	-	-	-	-	-	96	15,4*	86,0	108,0	-	-	-	101,0
94	-	-	131,0	-	-	-	121,0	96	15,4*	86,0	108,0	-	-	-	-	-	98	-	85,0	107,0	-	-	-	100,0
98	-	-	130,0	-	-	-	116,0	98	-	85,0	107,0	-	-	-	-	-	102	-	82,7	106,0	-	-	-	98,5
102	-	-	128,0	116,0	-	-	113,0	102	-	82,7	106,0	-	-	-	-	-	104	-	81,5	106,0	-	-	-	95,7
106	-	-	123,0	116,0	-	-	110,0	104	-	81,5	106,0	-	-	-	-	-	106	-	-	105,0	-	-	-	94,5
110	-	-	115,0	115,0	-	-	107,0	106	-	-	105,0	-	-	-	-	-	110	-	-	104,0	94,5	-	-	92,5
114	-	-	-	109,0	-	-	98,0	110	-	-	104,0	94,5	-	-	-	-	114	-	-	103,0	94,5	-	-	90,5
118	-	-	-	104,0	-	-	90,0	114	-	-	103,0	94,5	-	-	-	-	118	-	-	99,5	94,5	-	-	88,5
122	-	-	-	99,0	-	-	82,0	118	-	-	99,5	94,5	-	-	-	-	120	-	-	95,5	94,5	-	-	86,0
126	-	-	-	94,5	-	-	75,0	120	-	-	95,5	94,5	-	-	-	-	122	-	-	-	94,0	-	-	83,5
128	-	-	-	-	73,0	-	71,5	122	-	-	-	94,0	-	-	-	-	126	-	-	-	89,0	-	-	76,5
130	-	-	-	-	71,0	-	68,0	126	-	-	-	89,0	-	-	-	-	130	-	-	-	85,0	-	-	69,5
134	-	-	-	-	67,5	-	62,0	130	-	-	-	85,0	-	-	-	-	134	-	-	-	81,0	-	-	63,0
138	-	-	-	-	64,0	-	55,5	134	-	-	-	81,0	-	-	-	-	138	-	-	-	77,0	59,0	-	57,0
142	-	-	-	-	61,5	-	48,0	138	-	-	-	77,0	59,0	-	-	-	142	-	-	-	-	55,5	-	52,5
146	-	-	-	-	-	-	40,4	142	-	-	-	-	55,5	-	-	-	146	-	-	-	-	53,0	-	45,5
150	-	-	-	-	-	-	35,3	146	-	-	-	-	53,0	-	-	-	150	-	-	-	-	50,5	-	38,4
154	-	-	-	-	-	-	32,9	150	-	-	-	-	50,5	-	-	-	154	-	-	-	-	-	-	31,6
156	-	-	-	-	-	-	31,8	156	-	-	-	-	-	-	-	-	158	-	-	-	-	-	-	24,9
158	-	-	-	-	-	-	18,7	158	-	-	-	-	-	-	-	-	160	-	-	-	-	-	-	21,6
162	-	-	-	-	-	-	11,7	162	-	-	-	-	-	-	-	-	166	-	-	-	-	-	-	18,4
																								12,0



6 m steps of luffing jib is standard · 6 m Stufung der Wippe ist Standard · Des paliers de 6 m sont de série pour la flèche · Falcone standard con sezioni di 6 m · Incrementos de 6 m para plumín abatible son estándar · Lances de 6 m da lança auxiliar como padrão · 6 м шаг размера гуська является стандартом

* Main boom angle 88° · Hauptauslegerwinkel 88° · Jarret de flèche principale 88° · Inclinazione braccio base 88° · Ángulo de pluma principal 88° · Ángulo da lança principal 88° · Угол подъема гл. стрелы 88°

Main boom angle 88°, 85°, 75°, 65°, 55° and 45°; capacities for intermediate boom positions are calculated by the crane control system IC-1 · Hauptauslegerwinkel 88°, 85°, 75°, 65°, 55° und 45°; Traglasten für Zwischenstellungen des Hauptauslegers werden von der Kransteuerung IC-1 berechnet

Jarret de flèche principale 88°, 85°, 75°, 65°, 55° et 45°; le système de commande de la grue IC-1 calcule les charges pour les positions intermédiaires de la flèche

Inclinazione braccio base 88°, 85°, 75°, 65°, 55° e 45°; capacità per posizioni intermedie del braccio sono calcolate dal sistema di controllo della gru IC-1

Ángulo de pluma principal 88°, 85°, 75°, 65°, 55° y 45° las capacidades para posiciones de pluma intermedias son calculadas por el sistema de control de grúa IC-1

Ângulos da lança principal 88°, 85°, 75°, 65°, 55° e 45°; as capacidades para posições da lança intermediária são calculadas pelo sistema de controle da grua IC-1

Грузоподъемность при углах подъема главной стрелы 88°, 85°, 75°, 65°, 55° и 45°, грузоподъемность в промежуточных положениях стрелы рассчитывается системой управления краном IC-1

295 t + 60 t								19-30 m								10,5 m								9.8 m/s								360°								ISO																																																																																																																																																																																																																																																																																																																																																																																							
102 m + 108 m								SWSL								SFSL								108 m + 36 m								SWSL								SFSL																																																																																																																																																																																																																																																																																																																																																																																							
0 t								0 t - 640 t								0 t								0 t - 640 t								0 t								0 t - 640 t																																																																																																																																																																																																																																																																																																																																																																																							
88°/85°								88°/85°								75°								65°								55°								45°								88°/85°								88°/85°								75°								65°								55°								45°																																																																																																																																																																																																																																																																																																																																							
m								t								t								t								t								t								t								t								t								t																																																																																																																																																																																																																																																																																																																																																							
42	81,5*	90,5*	-	-	-	-	-	20	265,0*	283,0*	-	-	-	-	-	-	22	244,0*	276,0*	-	-	-	-	-	-	24	226,0*	269,0*	-	-	-	-	-	-	26	210,0*	262,0*	-	-	-	-	-	-	28	196,0*	291,0*	-	-	-	-	-	-	30	184,0*	285,0*	-	-	-	-	-	-	34	163,0*	272,0*	-	-	-	-	-	-	38	145,0*	260,0*	-	-	-	-	-	-	40	138,0*	254,0*	-	-	-	-	-	-	42	112,0*	249,0*	-	-	-	-	-	-	46	101,0*	240,0*	-	-	-	-	-	-	50	-	-	-	-	-	-	-	-	52	-	-	288,0	-	-	-	-	-	54	-	-	288,0	-	-	-	-	-	58	-	-	280,0	-	-	-	-	-	62	-	-	266,0	-	-	-	-	-	66	-	-	259,0	-	-	-	-	-	70	-	-	-	-	-	-	-	-	74	-	-	-	215,0	-	-	-	-	-	78	-	-	-	201,0	-	-	-	-	-	82	-	-	-	190,0	-	-	-	-	-	86	-	-	-	-	-	-	-	-	90	-	-	-	-	-	-	-	-	94	-	-	-	-	-	-	-	-	98	-	-	-	-	-	-	-	-	102	-	-	-	-	-	-	-	-	106	-	-	-	-	-	-	-	-	110	-	-	-	-	-	-	-	-	114	-	-	-	-	-	-	-	-	118	-	-	-	-	-	-	-	-	122	-	-	-	-	-	-	-	-	126	-	-	-	-	-	-	-	-	130	-	-	-	-	-	-	-	-	132	-	-	-	-	-	-	-	-	134	-	-	-	-	-	-	-	-	138	-	-	-	-	-	-	-	-	142	-	-	-	-	-	-	-	-	146	-	-	-	-	-	-	-	-	148	-	-	-	-	-	-	-	-	150	-	-	-	-	-	-	-	-	154	-	-	-	-	-	-	-	-	158	-	-	-	-	-	-	-	-	162	-	-	-	-	-	-	-	-	164	-	-	-	-	-	-	-	-	166	-	-	-	-	-	-	-	-

6 m steps of luffing jib is standard · 6 m Stufung der Wippe ist Standard · Des paliers de 6 m sont de série pour la fléchette · Falcone standard con sezioni di 6 m · Incrementos de 6 m para plumín abatible son estándar · Lances de 6 m da lança auxiliar como padrão · 6 м шаг размера гуська является стандартом

* Main boom angle 88° · Hauptauslegerwinkel 88° · Jarret de flèche principale 88° · Inclinazione braccio base 88° · Ángulo de pluma principal 88° · Ángulo da lança principal 88° · Угол подъема гл. стрелы 88°

Main boom angle 88°, 85°, 75°, 65°, 55° and 45°; capacities for intermediate boom positions are calculated by the crane control system IC-1 · Hauptauslegerwinkel 88°, 85°, 75°, 65°, 55° und 45°; Traglasten für Zwischenstellungen des Hauptauslegers werden von der Kransteuerung IC-1 berechnet

Jarret de flèche principale 88°, 85°, 75°, 65°, 55° et 45°; le système de commande de la grue IC-1 calcule les charges pour les positions intermédiaires de la flèche

Inclinazione braccio base 88°, 85°, 75°, 65°, 55° e 45°, capacità per posizioni intermedie del braccio sono calcolate dal sistema di controllo della gru IC-1

Ángulo de pluma principal 88°, 85°, 75°, 65°, 55° y 45° las capacidades para posiciones de pluma intermedias son calculadas por el sistema de control de grúa IC-1

Ángulos da lança principal 88°, 85°, 75°, 65°, 55° e 45°; as capacidades para posições da lança intermediária são calculadas pelo sistema de controle da grua IC-1

Грузоподъемность при углах подъема главной стрелы 88°, 85°, 75°, 65°, 55° и 45°, грузоподъемность в промежуточных положениях стрелы рассчитывается системой управления краном IC-1



295 t + 60 t		19-30 m		10,5 m		9.8 m/s		360°		ISO	
108 m + 48 m		SWSL		SFSL		108 m + 60 m		SWSL		SFSL	
0 t		0 t - 640 t		0 t		0 t - 640 t		0 t		0 t - 640 t	
		88°/85°		75°		65°		55°		45°	
m	t	t	t	t	t	t	t	t	t	t	t
24	211,0*	230,0*	-	-	-	-	-	-	-	-	-
26	196,0*	225,0*	-	-	-	-	-	-	-	-	-
28	183,0*	220,0*	-	-	-	-	-	-	-	-	-
30	171,0*	214,0*	-	-	-	-	-	-	-	-	-
32	161,0*	237,0	-	-	-	-	-	-	-	233,0	-
34	151,0*	233,0	-	-	-	-	-	-	-	233,0	-
38	135,0*	224,0	-	-	-	-	-	-	-	233,0	-
42	121,0*	215,0	-	-	-	-	-	-	-	233,0	-
46	109,0*	206,0	-	-	-	-	-	-	-	233,0	-
50	99,0*	199,0	-	-	-	-	-	-	-	233,0	-
52	94,5*	195,0	-	-	-	-	-	-	-	231,0	-
54	74,5	192,0	-	-	-	-	-	-	-	229,0	-
58	68,0	185,0	234,0	-	-	-	-	-	-	224,0	-
62	-	-	232,0	-	-	-	-	-	-	218,0	-
66	-	-	226,0	-	-	-	-	-	-	213,0	-
70	-	-	220,0	-	-	-	-	-	-	204,0	-
74	-	-	210,0	-	-	-	-	-	-	198,0	-
76	-	-	207,0	-	-	-	-	-	-	195,5	-
78	-	-	-	-	-	-	-	-	-	193,0	-
82	-	-	-	183,0	-	-	-	-	-	181,0	-
86	-	-	-	173,0	-	-	-	-	-	165,0	-
90	-	-	-	163,0	-	-	-	-	-	151,0	-
94	-	-	-	154,0	-	-	-	-	-	138,0	-
98	-	-	-	-	-	-	-	-	-	127,0	-
102	-	-	-	-	-	-	-	-	-	116,0	-
104	-	-	-	-	113,0	-	-	-	-	111,0	-
106	-	-	-	-	110,0	-	-	-	-	106,0	-
110	-	-	-	-	105,0	-	-	-	-	97,0	-
114	-	-	-	-	-	-	-	-	-	88,5	-
118	-	-	-	-	-	-	-	-	-	80,5	-
122	-	-	-	-	-	-	-	-	-	70,5	-
124	-	-	-	-	-	-	-	-	-	70,0	65,5
126	-	-	-	-	-	-	-	-	-	68,0	60,5
130	-	-	-	-	-	-	-	-	-	50,5	-
134	-	-	-	-	-	-	-	-	-	41,1	-
138	-	-	-	-	-	-	-	-	-	32,1	-

28	172,0*	189,0*	-	-	-	-	-	-	-	-	-
30	160,0*	185,0*	-	-	-	-	-	-	-	-	-
34	141,0*	177,0*	-	-	-	-	-	-	-	-	-
36	133,0*	194,0	-	-	-	-	-	-	-	-	191,0
38	126,0*	192,0	-	-	-	-	-	-	-	-	191,0
42	112,0*	186,0	-	-	-	-	-	-	-	-	191,0
46	101,0*	179,0	-	-	-	-	-	-	-	-	191,0
50	91,5*	172,0	-	-	-	-	-	-	-	-	191,0
54	83,0*	166,0	-	-	-	-	-	-	-	-	191,0
58	75,5*	161,0	-	-	-	-	-	-	-	-	190,0
62	69,0*	156,0	-	-	-	-	-	-	-	-	187,0
64	66,0*	153,0	192,0	-	-	-	-	-	-	-	185,0
66	49,9	151,0	192,0	-	-	-	-	-	-	-	183,0
70	45,2	146,0	189,0	-	-	-	-	-	-	-	179,0
74	-	-	185,0	-	-	-	-	-	-	-	175,0
78	-	-	180,0	-	-	-	-	-	-	-	171,0
82	-	-	176,0	-	-	-	-	-	-	-	165,0
86	-	-	170,0	-	-	-	-	-	-	-	161,0
88	-	-	167,0	-	-	-	-	-	-	-	159,0
90	-	-	-	161,0	-	-	-	-	-	-	157,0
94	-	-	-	152,0	-	-	-	-	-	-	145,0
98	-	-	-	144,0	-	-	-	-	-	-	133,0
102	-	-	-	137,0	-	-	-	-	-	-	122,0
106	-	-	-	130,0	-	-	-	-	-	-	112,0
110	-	-	-	-	-	-	-	-	-	-	103,0
114	-	-	-	-	-	-	-	96,5	-	-	94,0
118	-	-	-	-	-	-	-	92,0	-	-	86,0
122	-	-	-	-	-	-	-	87,5	-	-	78,5
126	-	-	-	-	-	-	-	-	-	-	71,5
130	-	-	-	-	-	-	-	-	-	-	62,5
134	-	-	-	-	-	-	-	-	-	57,0	53,5
136	-	-	-	-	-	-	-	-	-	55,5	49,2
138	-	-	-	-	-	-	-	-	-	-	45,0
142	-	-	-	-	-	-	-	-	-	-	36,4
146	-	-	-	-	-	-	-	-	-	-	28,0
150	-	-	-	-	-	-	-	-	-	-	20,9

0 t 100 t 180 t 240 t 340 t 440 t 540 t 640 t

6 m steps of luffing jib is standard · 6 m Stufung der Wippe ist Standard · Des paliers de 6 m sont de série pour la fléchette · Falcone standard con sezioni di 6 m · Incrementos de 6 m para plumín abatible son estándar · Lances de 6 m da lança auxiliar como padrão · 6 м шаг размера гуська является стандартом

* Main boom angle 88° · Hauptauslegerwinkel 88° · Jarret de flèche principale 88° · Inclinazione braccio base 88° · Ángulo de pluma principal 88° · Ángulo da lança principal 88° · Угол подъема гл. стрелы 88°

Main boom angle 88°, 85°, 75°, 65°, 55° and 45°; capacities for intermediate boom positions are calculated by the crane control system IC-1 · Hauptauslegerwinkel 88°, 85°, 75°, 65°, 55° und 45°; Traglasten für Zwischenstellungen des Hauptauslegers werden von der Kransteuerung IC-1 berechnet

Jarret de flèche principale 88°, 85°, 75°, 65°, 55° et 45°; le système de commande de la grue IC-1 calcule les charges pour les positions intermédiaires de la flèche

Inclinazione braccio base 88°, 85°, 75°, 65°, 55° e 45°; capacità per posizioni intermedie del braccio sono calcolate dal sistema di controllo della gru IC-1

Ángulo de pluma principal 88°, 85°, 75°, 65°, 55° y 45° las capacidades para posiciones de pluma intermedias son calculadas por el sistema de control de grúa IC-1

Ángulos da lança principal 88°, 85°, 75°, 65°, 55° e 45°; as capacidades para posições da lança intermediária são calculadas pelo sistema de controle da grua IC-1

Грузоподъемность при углах подъема главной стрелы 88°, 85°, 75°, 65°, 55° и 45°, грузоподъемность в промежуточных положениях стрелы рассчитывается системой управления краном IC-1

295 t + 60 t								19-30 m		10,5 m		9.8 m/s		360°		ISO									
114 m + 48 m								SWSL		SFSL		114 m + 60 m													
0 t								0 t - 800 t		0 t								0 t - 800 t							
88°/85°								88°/85°		75°		65°		55°		45°									
m	t	t	t	t	t	t	t	m	t	t	t	t	t	t	t	t	t								
24	-	199,0*	-	-	-	-	-	29	-	162,0*	-	-	-	-	-	-	-								
26	-	196,0*	-	-	-	-	-	30	-	160,0*	-	-	-	-	-	-	-								
28	178,0*	192,0*	-	-	-	-	-	32	143,0*	157,0*	-	-	-	-	-	-	-								
30	167,0*	188,0*	-	-	-	-	-	34	133,0*	154,0*	-	-	-	-	-	-	-								
33	151,5*	203,0	-	-	-	-	204,0	37	119,5*	166,0	-	-	-	-	-	-	167,0								
34	146,0*	202,0	-	-	-	-	204,0	38	115,0*	165,0	-	-	-	-	-	-	167,0								
38	127,0*	194,0	-	-	-	-	204,0	42	101,0*	159,0	-	-	-	-	-	-	167,0								
42	112,0*	185,0	-	-	-	-	204,0	46	89,0*	153,0	-	-	-	-	-	-	166,0								
46	98,5*	177,0	-	-	-	-	204,0	50	78,5*	147,0	-	-	-	-	-	-	166,0								
50	87,5*	170,0	-	-	-	-	202,0	54	69,0*	141,0	-	-	-	-	-	-	165,0								
53	81,0*	165,5	-	-	-	-	201,0	58	61,0*	136,0	-	-	-	-	-	-	164,0								
54	61,5	164,0	-	-	-	-	200,0	62	55,0*	131,0	-	-	-	-	-	-	162,0								
58	55,0	158,0	-	-	-	-	199,0	64	52,5*	129,0	-	-	-	-	-	-	161,0								
59	53,5	157,0	-	-	-	-	198,0	66	34,8	126,0	-	-	-	-	-	-	160,0								
61	-	-	196,0	-	-	-	196,0	67	33,7	125,0	160,0	-	-	-	-	-	159,2								
62	-	-	195,0	-	-	-	195,0	70	30,8	122,0	157,0	-	-	-	-	-	157,0								
66	-	-	189,0	-	-	-	191,0	74	-	-	153,0	-	-	-	-	-	154,0								
70	-	-	183,0	-	-	-	186,5	78	-	-	148,0	-	-	-	-	-	150,5								
74	-	-	177,0	-	-	-	182,0	82	-	-	144,0	-	-	-	-	-	147,0								
78	-	-	172,0	-	-	-	177,5	86	-	-	140,0	-	-	-	-	-	143,6								
82	-	-	-	-	-	-	173,0	90	-	-	136,0	-	-	-	-	-	140,0								
86	-	-	-	-	-	-	166,0	94	-	-	-	-	-	-	-	-	136,6								
89	-	-	-	165,0	-	-	163,0	97	-	-	-	134,0	-	-	-	-	133,5								
90	-	-	-	164,0	-	-	162,0	98	-	-	-	133,0	-	-	-	-	132,0								
94	-	-	-	159,0	-	-	149,5	102	-	-	-	129,0	-	-	-	-	126,0								
97	-	-	-	155,0	-	-	140,1	106	-	-	-	126,0	-	-	-	-	121,0								
98	-	-	-	-	-	-	137,0	108	-	-	-	124,0	-	-	-	-	115,5								
102	-	-	-	-	-	-	124,5	110	-	-	-	-	-	-	-	-	110,0								
106	-	-	-	-	-	-	112,0	114	-	-	-	-	-	-	-	-	99,0								
110	-	-	-	-	-	-	100,5	118	-	-	-	-	-	-	-	-	89,0								
114	-	-	-	-	-	-	89,0	122	-	-	-	-	-	-	-	-	79,0								
118	-	-	-	-	-	-	81,0	126	-	-	-	-	-	-	-	-	71,2								
122	-	-	-	-	-	-	72,0	130	-	-	-	-	-	-	-	-	63,5								
126	-	-	-	-	-	-	63,1	134	-	-	-	-	-	-	-	-	55,6								
130	-	-	-	-	-	-	54,0	138	-	-	-	-	-	-	-	-	47,8								
								140	-	-	-	-	-	-	-	-	43,9								

0 t 280 t 400 t 520 t 640 t 720 t 800 t

6 m steps of luffing jib is standard · 6 m Stufung der Wippe ist Standard · Des paliers de 6 m sont de série pour la fléchette · Falcone standard con sezioni di 6 m · Incrementos de 6 m para plumín abatible son estándar · Lances de 6 m da lança auxiliar como padrão · 6 м шаг размера гуська является стандартом

* Main boom angle 88° · Hauptauslegerwinkel 88° · Jarret de flèche principale 88° · Inclinazione braccio base 88° · Ángulo de pluma principal 88° · Ángulo da lança principal 88° · Угол подъема гл. стрелы 88°

Main boom angle 88°, 85°, 75°, 65°, 55° and 45°; capacities for intermediate boom positions are calculated by the crane control system IC-1 · Hauptauslegerwinkel 88°, 85°, 75°, 65°, 55° und 45°; Traglasten für Zwischenstellungen des Hauptauslegers werden von der Kransteuerung IC-1 berechnet

Jarret de flèche principale 88°, 85°, 75°, 65°, 55° et 45°; le système de commande de la grue IC-1 calcule les charges pour les positions intermédiaires de la flèche

Inclinazione braccio base 88°, 85°, 75°, 65°, 55° e 45°; capacità per posizioni intermedie del braccio sono calcolate dal sistema di controllo della gru IC-1







Ángulo de pluma principal 88°, 85°, 75°, 65°, 55° y 45° las capacidades para posiciones de pluma intermedias son calculadas por el sistema de control de grúa IC-1

Ángulos da lança principal 88°, 85°, 75°, 65°, 55° e 45°; as capacidades para posições da lança intermediária são calculadas pelo sistema de controle da grua IC-1

Грузоподъемность при углах подъема главной стрелы 88°, 85°, 75°, 65°, 55° и 45°, грузоподъемность в промежуточных положениях стрелы рассчитывается системой управления краном IC-1

295 t + 60 t 19-30 m 10,5 m 9.8 m/s 360° ISO								
114 m + 72 m								
SWSL				SFSL				
0 t			0 t - 800 t					
88°/85°		88°/85°		75°	65°	55°	45°	
m	t	t	t	t	t	t	t	t
33	-	131,0*	-	-	-	-	-	-
34	-	129,0*	-	-	-	-	-	-
36	101,0*	127,0*	-	-	-	-	-	-
38	93,5*	125,0*	-	-	-	-	-	-
42	81,0*	133,0	-	-	-	-	-	134,0
46	70,5*	129,0	-	-	-	-	-	134,0
50	62,0*	125,0	-	-	-	-	-	134,0
54	54,5*	120,0	-	-	-	-	-	134,0
58	47,8*	116,0	-	-	-	-	-	133,0
62	41,8*	112,0	-	-	-	-	-	132,0
66	36,7*	107,0	-	-	-	-	-	131,0
70	32,4*	104,0	-	-	-	-	-	129,0
74	29,0*	100,0	128,0	-	-	-	-	127,0
76	24,4*	98,5	126,0	-	-	-	-	125,7
78	-	97,0	125,0	-	-	-	-	124,5
82	-	93,5	122,0	-	-	-	-	122,0
86	-	-	119,0	-	-	-	-	119,0
90	-	-	115,0	-	-	-	-	116,0
94	-	-	112,0	-	-	-	-	113,5
98	-	-	109,0	-	-	-	-	111,0
100	-	-	107,0	-	-	-	-	109,6
102	-	-	-	-	-	-	-	108,3
105	-	-	-	107,0	-	-	-	105,5
106	-	-	-	106,0	-	-	-	104,0
110	-	-	-	104,0	-	-	-	100,5
114	-	-	-	102,0	-	-	-	98,0
118	-	-	-	99,0	-	-	-	90,5
120	-	-	-	97,5	-	-	-	86,7
122	-	-	-	-	-	-	-	83,0
126	-	-	-	-	-	-	-	74,2
130	-	-	-	-	-	-	-	65,5
134	-	-	-	-	-	-	-	57,4
138	-	-	-	-	-	-	-	49,4
142	-	-	-	-	-	-	-	41,8
146	-	-	-	-	-	-	-	34,4
150	-	-	-	-	-	-	-	27,3
151	-	-	-	-	-	-	-	25,6

114 m + 84 m								
SWSL				SFSL				
0 t			0 t - 800 t					
88°/85°		88°/85°		75°	65°	55°	45°	
m	t	t	t	t	t	t	t	t
37	-	104,0*	-	-	-	-	-	-
38	-	104,0*	-	-	-	-	-	-
40	73,0*	102,0*	-	-	-	-	-	-
42	67,5*	100,0*	-	-	-	-	-	-
46	57,5*	107,0	-	-	-	-	-	108,0
50	49,4*	104,0	-	-	-	-	-	107,0
54	42,6*	101,0	-	-	-	-	-	107,0
58	36,6*	97,5	-	-	-	-	-	107,0
62	31,1*	94,0	-	-	-	-	-	107,0
66	26,2*	91,0	-	-	-	-	-	106,0
70	21,9*	87,5	-	-	-	-	-	104,6
71	20,9*	86,7	-	-	-	-	-	104,2
74	-	84,5	-	-	-	-	-	103,0
78	-	81,5	-	-	-	-	-	101,5
80	-	80,0	102,0	-	-	-	-	100,7
82	-	78,5	101,0	-	-	-	-	100,0
86	-	75,5	99,0	-	-	-	-	98,0
87	-	74,7	98,5	-	-	-	-	97,5
90	-	72,7	97,0	-	-	-	-	96,0
93	-	71,0	95,0	-	-	-	-	94,3
94	-	-	94,5	-	-	-	-	93,7
98	-	-	92,0	-	-	-	-	91,5
102	-	-	89,5	-	-	-	-	89,2
106	-	-	87,0	-	-	-	-	87,0
110	-	-	85,0	-	-	-	-	85,0
112	-	-	84,0	-	-	-	-	84,0
113	-	-	-	84,5	-	-	-	83,2
114	-	-	-	83,5	-	-	-	82,5
118	-	-	-	82,0	-	-	-	78,2
122	-	-	-	80,5	-	-	-	76,0
126	-	-	-	78,5	-	-	-	70,7
130	-	-	-	76,5	-	-	-	65,5
132	-	-	-	75,5	-	-	-	61,6
134	-	-	-	-	-	-	-	57,7
138	-	-	-	-	-	-	-	50,0
142	-	-	-	-	-	-	-	42,8
146	-	-	-	-	-	-	-	35,7
150	-	-	-	-	-	-	-	28,9
154	-	-	-	-	-	-	-	22,2
155	-	-	-	-	-	-	-	20,7

						
---	---	---	---	---	---	---

6 m steps of luffing jib is standard · 6 m Stufung der Wippe ist Standard · Des paliers de 6 m sont de série pour la fléchette · Falcone standard con sezioni di 6 m · Incrementos de 6 m para plumín abatible son estándar · Lancas de 6 m da lança auxiliar como padrão · 6 м шаг размера гуська является стандартом

* Main boom angle 88° · Hauptauslegerwinkel 88° · Jarret de flèche principale 88° · Inclinação braccio base 88° · Ángulo de pluma principal 88° · Ángulo da lança principal 88° · Угол подъема гл. стрелы 88°

Main boom angle 88°, 85°, 75°, 65°, 55° and 45°; capacities for intermediate boom positions are calculated by the crane control system IC-1
 Hauptauslegerwinkel 88°, 85°, 75°, 65°, 55° und 45°; Traglasten für Zwischenstellungen des Hauptauslegers werden von der Kransteuerung IC-1 berechnet

Jarret de flèche principale 88°, 85°, 75°, 65°, 55° et 45°; le système de commande de la grue IC-1 calcule les charges pour les positions intermédiaires de la flèche

Inclinazione braccio base 88°, 85°, 75°, 65°, 55° e 45°, capacità per posizioni intermedie del braccio sono calcolate dal sistema di controllo della gru IC-1

Ángulo de pluma principal 88°, 85°, 75°, 65°, 55° y 45° las capacidades para posiciones de pluma intermedias son calculadas por el sistema de control de grúa IC-1

Ângulos da lança principal 88°, 85°, 75°, 65°, 55° e 45°; as capacidades para posições da lança intermediária são calculadas pelo sistema de controle da grua IC-1

Грузоподъемность при углах подъема главной стрелы 88°, 85°, 75°, 65°, 55° и 45°, грузоподъемность в промежуточных положениях стрелы рассчитывается системой управления краном IC-1

295 t + 60 t									19-30 m									10,5 m									9.8 m/s									360°									ISO								
114 m + 96 m																		114 m + 108 m																																			
SWSL									SFSL									SWSL									SFSL																										
0 t									0 t - 800 t									0 t									0 t - 800 t																										
88°/85°									88°/85°									75°									65°									55°									45°								
m	t	t	t	t	t	t	t	t	m	t	t	t	t	t	t	t	t	m	t	t	t	t	t	t	t	t	m	t	t	t	t	t	t	t	t																		
41	-	82,5*	-	-	-	-	-	-	45	-	63,5*	-	-	-	-	-	-	45	-	63,5*	-	-	-	-	-	-	-	-	-																								
42	-	82,0*	-	-	-	-	-	-	46	-	63,0*	-	-	-	-	-	-	46	-	63,0*	-	-	-	-	-	-	-	-	-																								
44	50,5*	80,5*	-	-	-	-	-	-	48	30,8*	61,5*	-	-	-	-	-	-	48	30,8*	61,5*	-	-	-	-	-	-	-	-	-																								
46	46,7*	79,5*	-	-	-	-	-	-	50	27,3*	60,5*	-	-	-	-	-	-	50	27,3*	60,5*	-	-	-	-	-	-	-	-	-																								
50	38,3*	85,0	-	-	-	-	-	85,0	54	21,0*	57,5*	-	-	-	-	-	-	54	21,0*	57,5*	-	-	-	-	-	-	-	-	-																								
54	31,7*	83,0	-	-	-	-	-	85,0	55	-	65,0	-	-	-	-	-	65,5	55	-	65,0	-	-	-	-	-	-	-	-	65,5																								
58	25,7*	80,5	-	-	-	-	-	85,0	58	-	64,0	-	-	-	-	-	65,5	58	-	64,0	-	-	-	-	-	-	-	65,5																									
62	20,4*	78,0	-	-	-	-	-	84,5	62	-	62,0	-	-	-	-	-	65,0	62	-	62,0	-	-	-	-	-	-	-	65,0																									
66	-	75,5	-	-	-	-	-	84,5	66	-	60,5	-	-	-	-	-	65,0	66	-	60,5	-	-	-	-	-	-	-	65,0																									
70	-	72,5	-	-	-	-	-	83,3	70	-	58,5	-	-	-	-	-	64,2	70	-	58,5	-	-	-	-	-	-	-	64,2																									
74	-	70,0	-	-	-	-	-	82,5	74	-	56,5	-	-	-	-	-	64,0	74	-	56,5	-	-	-	-	-	-	-	64,0																									
78	-	67,5	-	-	-	-	-	81,5	78	-	54,0	-	-	-	-	-	63,2	78	-	54,0	-	-	-	-	-	-	-	63,2																									
82	-	65,0	-	-	-	-	-	80,5	82	-	52,0	-	-	-	-	-	62,5	82	-	52,0	-	-	-	-	-	-	-	62,5																									
86	-	62,5	79,5	-	-	-	-	79,0	86	-	50,0	-	-	-	-	-	61,5	86	-	50,0	-	-	-	-	-	-	-	61,5																									
90	-	60,2	78,5	-	-	-	-	77,5	90	-	47,7	-	-	-	-	-	60,5	90	-	47,7	-	-	-	-	-	-	-	60,5																									
94	-	57,7	77,0	-	-	-	-	75,7	94	-	45,9	60,0	-	-	-	-	59,3	94	-	45,9	60,0	-	-	-	-	-	-	59,3																									
98	-	55,0	75,5	-	-	-	-	74,0	98	-	45,3	59,5	-	-	-	-	59,0	98	-	45,3	59,5	-	-	-	-	-	-	59,0																									
102	-	52,0	74,0	-	-	-	-	72,2	102	-	42,9	59,0	-	-	-	-	57,5	102	-	42,9	59,0	-	-	-	-	-	-	57,5																									
104	-	50,5	73,0	-	-	-	-	71,3	104	-	40,5	58,0	-	-	-	-	56,0	104	-	40,5	58,0	-	-	-	-	-	-	56,0																									
106	-	-	72,0	-	-	-	-	70,5	106	-	38,1	57,0	-	-	-	-	54,5	106	-	38,1	57,0	-	-	-	-	-	-	54,5																									
110	-	-	70,5	-	-	-	-	68,5	109	-	36,4	56,0	-	-	-	-	53,3	109	-	36,4	56,0	-	-	-	-	-	-	53,3																									
114	-	-	68,5	-	-	-	-	66,5	110	-	35,8	55,5	-	-	-	-	53,0	110	-	35,8	55,5	-	-	-	-	-	-	53,0																									
118	-	-	67,0	-	-	-	-	65,0	114	-	33,4	54,5	-	-	-	-	51,5	114	-	33,4	54,5	-	-	-	-	-	-	51,5																									
122	-	-	65,0	65,0	-	-	-	61,5	116	-	32,3	54,0	-	-	-	-	51,0	116	-	32,3	54,0	-	-	-	-	-	-	51,0																									
124	-	-	64,0	64,0	-	-	-	60,6	118	-	-	53,0	-	-	-	-	50,3	118	-	-	53,0	-	-	-	-	-	-	50,3																									
126	-	-	-	63,5	-	-	-	59,7	122	-	-	52,0	-	-	-	-	49,0	122	-	-	52,0	-	-	-	-	-	-	49,0																									
130	-	-	-	62,0	-	-	-	58,0	126	-	-	50,5	-	-	-	-	47,5	126	-	-	50,5	-	-	-	-	-	-	47,5																									
134	-	-	-	61,0	-	-	-	55,7	130	-	-	49,5	48,2	-	-	-	44,5	130	-	-	49,5	48,2	-	-	-	-	-	44,5																									
138	-	-	-	59,5	-	-	-	53,5	134	-	-	48,1	46,7	-	-	-	43,0	134	-	-	48,1	46,7	-	-	-	-	-	43,0																									
142	-	-	-	58,0	-	-	-	46,6	136	-	-	47,5	46,3	-	-	-	42,2	136	-	-	47,5	46,3	-	-	-	-	-	42,2																									
146	-	-	-	-	-	-	-	39,7	138	-	-	-	46,0	-	-	-	41,5	138	-	-	-	46,0	-	-	-	-	-	41,5																									
150	-	-	-	-	-	-	-	33,1	142	-	-	-	45,3	-	-	-	39,6	142	-	-	-	45,3	-	-	-	-	-	39,6																									
154	-	-	-	-	-	-	-	26,6	146	-	-	-	44,4	-	-	-	37,8	146	-	-	-	44,4	-	-	-	-	-	37,8																									
158	-	-	-	-	-	-	-	20,4	150	-	-	-	43,4	-	-	-	32,6	150	-	-	-	43,4	-	-	-	-	-	32,6																									
									154	-	-	-	42,3	-	-	-	27,5	154	-	-	-	42,3	-	-	-	-	-	27,5																									
									158	-	-	-	-	-	-	-	21,5	158	-	-	-	-	-	-	-	-	-	21,5																									
									159	-	-	-	-	-	-	-	20,1	159	-	-	-	-	-	-	-	-	-	20,1																									

6 m steps of luffing jib is standard · 6 m Stufung der Wippe ist Standard · Des paliers de 6 m sont de série pour la fléchette · Falcone standard con sezioni di 6 m · Incrementos de 6 m para plumín abatible son estándar · Lances de 6 m da lança auxiliar como padrão · 6 м шаг размера гуська является стандартом

* Main boom angle 88° · Hauptauslegerwinkel 88° · Jarret de flèche principale 88° · Inclinazione braccio base 88° · Ângulo de pluma principal 88° · Ângulo da lança principal 88° · Угол подъема гл. стрелы 88°

Main boom angle 88°, 85°, 75°, 65°, 55° and 45°; capacities for intermediate boom positions are calculated by the crane control system IC-1 · Hauptauslegerwinkel 88°, 85°, 75°, 65°, 55° und 45°; Traglasten für Zwischenstellungen des Hauptauslegers werden von der Kransteuerung IC-1 berechnet

Jarret de flèche principale 88°, 85°, 75°, 65°, 55° et 45°; le système de commande de la grue IC-1 calcule les charges pour les positions intermédiaires de la flèche

Inclinazione braccio base 88°, 85°, 75°, 65°, 55° e 45°, capacità per posizioni intermedie del braccio sono calcolate dal sistema di controllo della gru IC-1

Ângulo de pluma principal 88°, 85°, 75°, 65°, 55° y 45° las capacidades para posiciones de pluma intermedias son calculadas por el sistema de control de grúa IC-1

Ângulos da lança principal 88°, 85°, 75°, 65°, 55° e 45°; as capacidades para posições da lança intermediária são calculadas pelo sistema de controle da grua IC-1

Грузоподъемность при углах подъема главной стрелы 88°, 85°, 75°, 65°, 55° и 45°, грузоподъемность в промежуточных положениях стрелы рассчитывается системой управления краном IC-1

295 t + 60 t								19-30 m		10,5 m		9.8 m/s		360°		ISO											
114 m + 120 m										120 m + 60 m																	
SWSL								SFSL		SWSL								SFSL									
0 t								0 t - 800 t		0 t								0 t - 800 t									
		88°/85°		88°/85°		75°		65°		55°		45°				88°/85°		88°/85°		75°		65°		55°		45°	
m		t		t		t		t		t		t		t		m		t		t		t		t		t	
49	-	45,1	*	-	-	-	-	-	-	-	-	-	-	-	-	29	-	145,0	*	-	-	-	-	-	-	-	-
50	-	44,6	*	-	-	-	-	-	-	-	-	-	-	-	-	30	-	144,0	*	-	-	-	-	-	-	-	-
54	-	42,7	*	-	-	-	-	-	-	-	-	-	-	-	-	32	132,0	*	141,0	*	-	-	-	-	-	-	-
58	-	40,5	*	-	-	-	-	-	-	-	-	-	-	-	-	34	124,0	*	139,0	*	-	-	-	-	-	-	-
59	-	48,0	-	-	-	-	-	-	-	-	-	-	-	-	-	38	108,0	*	149,0	-	-	-	-	-	-	149,0	
62	-	47,1	-	-	-	-	-	-	-	-	-	-	-	-	-	42	94,5	*	143,0	-	-	-	-	-	-	149,0	
66	-	45,8	-	-	-	-	-	-	-	-	-	-	-	-	-	46	83,0	*	138,0	-	-	-	-	-	-	148,0	
70	-	44,4	-	-	-	-	-	-	-	-	-	-	-	-	-	50	73,0	*	132,0	-	-	-	-	-	-	148,0	
74	-	42,6	-	-	-	-	-	-	-	-	-	-	-	-	-	54	64,0	*	127,0	-	-	-	-	-	-	147,0	
78	-	40,9	-	-	-	-	-	-	-	-	-	-	-	-	-	58	56,5	*	122,0	-	-	-	-	-	-	145,0	
82	-	39,0	-	-	-	-	-	-	-	-	-	-	-	-	-	62	50,5	*	117,0	-	-	-	-	-	-	143,0	
86	-	36,9	-	-	-	-	-	-	-	-	-	-	-	-	-	65	43,3	*	114,0	-	-	-	-	-	-	141,5	
90	-	34,9	-	-	-	-	-	-	-	-	-	-	-	-	-	66	29,6	-	113,0	-	-	-	-	-	-	141,0	
94	-	32,8	-	-	-	-	-	-	-	-	-	-	-	-	-	69	26,7	-	110,0	139,0	-	-	-	-	-	138,3	
95	-	32,3	-	-	-	-	-	-	-	-	-	-	-	-	-	70	25,9	-	109,0	138,0	-	-	-	-	-	137,5	
98	-	30,8	-	-	-	-	-	-	-	-	-	-	-	-	-	71	25,1	-	108,0	137,0	-	-	-	-	-	136,6	
99	-	30,3	42,8	-	-	-	-	-	-	-	-	-	-	-	-	74	-	-	-	134,0	-	-	-	-	-	134,0	
102	-	28,8	42,4	-	-	-	-	-	-	-	-	-	-	-	-	78	-	-	-	129,0	-	-	-	-	-	130,5	
106	-	26,8	42,0	-	-	-	-	-	-	-	-	-	-	-	-	82	-	-	-	125,0	-	-	-	-	-	127,0	
110	-	24,8	41,4	-	-	-	-	-	-	-	-	-	-	-	-	86	-	-	-	121,0	-	-	-	-	-	123,5	
114	-	22,8	40,5	-	-	-	-	-	-	-	-	-	-	-	-	90	-	-	-	117,0	-	-	-	-	-	120,0	
118	-	20,8	39,6	-	-	-	-	-	-	-	-	-	-	-	-	92	-	-	-	115,0	-	-	-	-	-	118,2	
119	-	20,3	39,4	-	-	-	-	-	-	-	-	-	-	-	-	94	-	-	-	-	-	-	-	-	-	116,5	
122	-	-	38,7	-	-	-	-	-	-	-	-	-	-	-	-	98	-	-	-	-	-	-	-	-	-	113,0	
126	-	-	37,9	-	-	-	-	-	-	-	-	-	-	-	-	100	-	-	-	-	112,0	-	-	-	-	-	111,0
130	-	-	36,9	-	-	-	-	-	-	-	-	-	-	-	-	102	-	-	-	-	110,0	-	-	-	-	-	109,0
134	-	-	35,9	-	-	-	-	-	-	-	-	-	-	-	-	106	-	-	-	-	106,0	-	-	-	-	-	105,0
137	-	-	35,2	-	-	-	-	-	-	-	-	-	-	-	-	110	-	-	-	-	102,0	-	-	-	-	-	99,0
138	-	-	35,0	32,2	-	-	-	-	-	-	-	-	-	-	-	114	-	-	-	-	-	-	-	-	-	95,0	
142	-	-	34,0	31,1	-	-	-	-	-	-	-	-	-	-	-	118	-	-	-	-	-	-	-	-	-	85,2	
146	-	-	33,0	30,8	-	-	-	-	-	-	-	-	-	-	-	122	-	-	-	-	-	-	-	-	-	75,5	
150	-	-	-	30,5	-	-	-	-	-	-	-	-	-	-	-	126	-	-	-	-	-	-	-	-	-	67,0	
154	-	-	-	30,2	-	-	-	-	-	-	-	-	-	-	-	130	-	-	-	-	-	-	-	-	-	59,5	
158	-	-	-	29,5	-	-	-	-	-	-	-	-	-	-	-	134	-	-	-	-	-	-	-	-	-	51,9	
162	-	-	-	28,8	-	-	-	-	-	-	-	-	-	-	-	138	-	-	-	-	-	-	-	-	-	44,3	
166	-	-	-	28,0	-	-	-	-	-	-	-	-	-	-	-	142	-	-	-	-	-	-	-	-	-	36,5	
																145	-	-	-	-	-	-	-	-	-	30,7	

0 t 280 t 400 t 520 t 640 t 720 t 800 t

6 m steps of luffing jib is standard · 6 m Stufung der Wippe ist Standard · Des paliers de 6 m sont de série pour la fléchette · Falcone standard con sezioni di 6 m · Incrementos de 6 m para plumín abatible son estándar · Lances de 6 m da lança auxiliar como padrão · 6 м шаг размера гуська является стандартом

* Main boom angle 88° · Hauptauslegerwinkel 88° · Jarret de flèche principale 88° · Inclinazione braccio base 88° · Ángulo de pluma principal 88° · Ángulo da lança principal 88° · Угол подъема гл. стрелы 88°

Main boom angle 88°, 85°, 75°, 65°, 55° and 45°; capacities for intermediate boom positions are calculated by the crane control system IC-1 · Hauptauslegerwinkel 88°, 85°, 75°, 65°, 55° und 45°; Traglasten für Zwischenstellungen des Hauptauslegers werden von der Kransteuerung IC-1 berechnet

Jarret de flèche principale 88°, 85°, 75°, 65°, 55° et 45°; le système de commande de la grue IC-1 calcule les charges pour les positions intermédiaires de la flèche

Inclinazione braccio base 88°, 85°, 75°, 65°, 55° e 45°; capacità per posizioni intermedie del braccio sono calcolate dal sistema di controllo della gru IC-1

Ángulo de pluma principal 88°, 85°, 75°, 65°, 55° y 45° las capacidades para posiciones de pluma intermedias son calculadas por el sistema de control de grúa IC-1

Ángulos da lança principal 88°, 85°, 75°, 65°, 55° e 45°; as capacidades para posições da lança intermediária são calculadas pelo sistema de controle da grua IC-1

Грузоподъемность при углах подъема главной стрелы 88°, 85°, 75°, 65°, 55° и 45°, грузоподъемность в промежуточных положениях стрелы рассчитывается системой управления краном IC-1

295 t + 60 t								19-30 m								10,5 m		9.8 m/s		360°		ISO							
120 m + 72 m								SWSL								SFSL		120 m + 84 m								SWSL		SFSL	
0 t				0 t-800 t				0 t				0 t-800 t				0 t		0 t-800 t		0 t		0 t-800 t							
88°/85°		88°/85°		75°		65°		55°		45°		88°/85°		88°/85°		75°		65°		55°		45°							
m	t	t	t	t	t	t	t	m	t	t	t	t	t	t	t	t	t	m	t	t	t	t	t						
33	-	117,0*	-	-	-	-	-	37	-	93,0*	-	-	-	-	-	-	-	37	-	93,0*	-	-	-	-					
34	-	116,0*	-	-	-	-	-	38	-	92,0*	-	-	-	-	-	-	-	38	-	92,0*	-	-	-	-					
36	92,5*	114,0*	-	-	-	-	-	40	65,5*	90,5*	-	-	-	-	-	-	-	40	65,5*	90,5*	-	-	-	-					
38	85,5*	112,0*	-	-	-	-	-	42	60,0*	89,0*	-	-	-	-	-	-	-	42	60,0*	89,0*	-	-	-	-					
42	74,0*	120,0	-	-	-	-	-	46	51,0*	85,5*	-	-	-	-	-	-	-	46	51,0*	85,5*	-	-	-	-					
46	64,0*	116,0	-	-	-	-	-	47	49,0*	95,0	-	-	-	-	-	-	-	47	49,0*	95,0	-	-	-	95,5					
50	56,0*	112,0	-	-	-	-	-	50	43,3*	92,5	-	-	-	-	-	-	-	50	43,3*	92,5	-	-	-	95,0					
54	49,2*	108,0	-	-	-	-	-	54	36,9*	89,5	-	-	-	-	-	-	-	54	36,9*	89,5	-	-	-	94,5					
58	42,8*	103,0	-	-	-	-	-	58	31,3*	86,5	-	-	-	-	-	-	-	58	31,3*	86,5	-	-	-	94,0					
62	37,2*	99,5	-	-	-	-	-	62	26,2*	83,5	-	-	-	-	-	-	-	62	26,2*	83,5	-	-	-	93,5					
66	32,4*	96,0	-	-	-	-	-	66	21,7*	80,0	-	-	-	-	-	-	-	66	21,7*	80,0	-	-	-	92,5					
70	28,4*	92,5	-	-	-	-	-	67	20,6*	79,2	-	-	-	-	-	-	-	67	20,6*	79,2	-	-	-	92,1					
74	25,2*	89,0	-	-	-	-	-	70	-	77,0	-	-	-	-	-	-	-	70	-	77,0	-	-	-	91,2					
75	24,5*	88,0	111,0	-	-	-	-	74	-	74,0	-	-	-	-	-	-	-	74	-	74,0	-	-	-	90,0					
76	23,9*	87,0	110,0	-	-	-	-	78	-	71,5	-	-	-	-	-	-	-	78	-	71,5	-	-	-	88,5					
78	-	85,5	109,0	-	-	-	-	82	-	68,5	87,0	-	-	-	-	-	-	82	-	68,5	87,0	-	-	86,5					
82	-	82,5	106,0	-	-	-	-	86	-	65,7	85,5	-	-	-	-	-	-	86	-	65,7	85,5	-	-	84,2					
86	-	-	103,0	-	-	-	-	87	-	65,1	84,7	-	-	-	-	-	-	87	-	65,1	84,7	-	-	83,6					
90	-	-	100,0	-	-	-	-	90	-	63,2	83,0	-	-	-	-	-	-	90	-	63,2	83,0	-	-	82,0					
94	-	-	97,0	-	-	-	-	94	-	61,0	80,5	-	-	-	-	-	-	94	-	61,0	80,5	-	-	79,5					
98	-	-	93,5	-	-	-	-	98	-	-	78,0	-	-	-	-	-	-	98	-	-	78,0	-	-	77,0					
102	-	-	90,5	-	-	-	-	102	-	-	76,0	-	-	-	-	-	-	102	-	-	76,0	-	-	74,5					
106	-	-	-	-	-	-	-	106	-	-	73,5	-	-	-	-	-	-	106	-	-	73,5	-	-	72,0					
108	-	-	-	89,0	-	-	-	110	-	-	71,0	-	-	-	-	-	-	110	-	-	71,0	-	-	69,7					
110	-	-	-	87,5	-	-	-	114	-	-	69,0	-	-	-	-	-	-	114	-	-	69,0	-	-	67,5					
114	-	-	-	85,0	-	-	-	116	-	-	-	68,5	-	-	-	-	-	116	-	-	-	68,5	-	64,8					
118	-	-	-	81,5	-	-	-	118	-	-	-	67,5	-	-	-	-	-	118	-	-	-	67,5	-	63,5					
122	-	-	-	78,0	-	-	-	122	-	-	-	65,5	-	-	-	-	-	122	-	-	-	65,5	-	61,0					
126	-	-	-	-	-	-	-	126	-	-	-	63,0	-	-	-	-	-	126	-	-	-	63,0	-	58,5					
130	-	-	-	-	-	-	-	130	-	-	-	60,5	-	-	-	-	-	130	-	-	-	60,5	-	56,0					
134	-	-	-	-	-	-	-	134	-	-	-	58,0	-	-	-	-	-	134	-	-	-	58,0	-	51,1					
138	-	-	-	-	-	-	-	138	-	-	-	-	-	-	-	-	-	138	-	-	-	-	-	46,3					
142	-	-	-	-	-	-	-	142	-	-	-	-	-	-	-	-	-	142	-	-	-	-	-	39,2					
146	-	-	-	-	-	-	-	146	-	-	-	-	-	-	-	-	-	146	-	-	-	-	-	32,2					
150	-	-	-	-	-	-	-	150	-	-	-	-	-	-	-	-	-	150	-	-	-	-	-	25,6					
152	-	-	-	-	-	-	-	152	-	-	-	-	-	-	-	-	-	152	-	-	-	-	-	20,9					



6 m steps of luffing jib is standard · 6 m Stufung der Wippe ist Standard · Des paliers de 6 m sont de série pour la fléchette · Falcone standard con sezioni di 6 m · Incrementos de 6 m para plumín abatible son estándar · Lances de 6 m da lança auxiliar como padrão · 6 м шаг размера гуська является стандартом

* Main boom angle 88° · Hauptauslegerwinkel 88° · Jarret de flèche principale 88° · Inclinazione braccio base 88° · Ángulo de pluma principal 88° · Ángulo da lança principal 88° · Угол подъема гл. стрелы 88°

Main boom angle 88°, 85°, 75°, 65°, 55° and 45°; capacities for intermediate boom positions are calculated by the crane control system IC-1 · Hauptauslegerwinkel 88°, 85°, 75°, 65°, 55° und 45°; Traglasten für Zwischenstellungen des Hauptauslegers werden von der Kransteuerung IC-1 berechnet

Jarret de flèche principale 88°, 85°, 75°, 65°, 55° et 45°; le système de commande de la grue IC-1 calcule les charges pour les positions intermédiaires de la flèche

Inclinazione braccio base 88°, 85°, 75°, 65°, 55° e 45°; capacità per posizioni intermedie del braccio sono calcolate dal sistema di controllo della gru IC-1

Ángulo de pluma principal 88°, 85°, 75°, 65°, 55° y 45° las capacidades para posiciones de pluma intermedias son calculadas por el sistema de control de grúa IC-1

Ángulos da lança principal 88°, 85°, 75°, 65°, 55° e 45°; as capacidades para posições da lança intermediária são calculadas pelo sistema de controle da grua IC-1

Грузоподъемность при углах подъема главной стрелы 88°, 85°, 75°, 65°, 55° и 45°, грузоподъемность в промежуточных положениях стрелы рассчитывается системой управления краном IC-1

295 t + 60 t 19-30 m 10,5 m 9.8 m/s 360° ISO								
120 m + 96 m								
SWSL					SFSL			
0 t		0 t - 800 t						
88°/85°		88°/85°		75°	65°	55°	45°	
m	t	t	t	t	t	t	t	t
41	-	72,5*	-	-	-	-	-	-
42	-	72,0*	-	-	-	-	-	-
44	43,6*	71,0*	-	-	-	-	-	-
46	39,8*	69,5*	-	-	-	-	-	-
50	32,2*	66,5*	-	-	-	-	-	-
51	30,6*	74,5	-	-	-	-	74,5	-
54	26,0*	72,5	-	-	-	-	74,5	-
58	20,4*	70,5	-	-	-	-	74,0	-
62	-	68,0	-	-	-	-	73,5	-
66	-	65,5	-	-	-	-	73,0	-
70	-	63,0	-	-	-	-	72,0	-
74	-	61,0	-	-	-	-	71,0	-
78	-	58,0	-	-	-	-	70,0	-
82	-	55,7	-	-	-	-	69,0	-
86	-	53,5	-	-	-	-	67,5	-
88	-	52,5	67,0	-	-	-	66,7	-
90	-	51,2	66,5	-	-	-	66,0	-
94	-	48,7	65,0	-	-	-	64,0	-
98	-	46,1	63,5	-	-	-	62,0	-
102	-	43,5	62,0	-	-	-	60,0	-
105	-	41,6	60,5	-	-	-	58,5	-
106	-	-	60,0	-	-	-	58,0	-
110	-	-	58,0	-	-	-	56,0	-
114	-	-	56,5	-	-	-	54,0	-
118	-	-	54,5	-	-	-	52,0	-
122	-	-	52,5	-	-	-	50,0	-
124	-	-	52,0	51,5	-	-	47,8	-
126	-	-	51,0	50,5	-	-	46,8	-
130	-	-	-	49,4	-	-	44,8	-
134	-	-	-	47,1	-	-	42,6	-
138	-	-	-	45,4	-	-	40,4	-
142	-	-	-	43,7	-	-	37,5	-
146	-	-	-	42,1	-	-	34,6	-
150	-	-	-	-	-	-	28,8	-
154	-	-	-	-	-	-	23,1	-
156	-	-	-	-	-	-	20,1	-

120 m + 108 m								
SWSL					SFSL			
0 t		0 t - 800 t						
88°/85°		88°/85°		75°	65°	55°	45°	
m	t	t	t	t	t	t	t	t
45	-	53,5*	-	-	-	-	-	-
46	-	53,0*	-	-	-	-	-	-
50	-	50,5*	-	-	-	-	-	-
54	-	48,4*	-	-	-	-	-	-
55	-	56,5	-	-	-	-	-	56,5
58	-	55,0	-	-	-	-	-	56,0
62	-	53,5	-	-	-	-	-	56,0
66	-	51,5	-	-	-	-	-	55,5
70	-	49,8	-	-	-	-	-	55,0
74	-	47,6	-	-	-	-	-	54,5
78	-	45,7	-	-	-	-	-	53,5
82	-	43,4	-	-	-	-	-	52,5
86	-	41,1	-	-	-	-	-	51,5
90	-	38,8	-	-	-	-	-	50,5
94	-	36,5	49,8	-	-	-	-	49,1
98	-	34,3	49,0	-	-	-	-	47,8
101	-	32,6	48,2	-	-	-	-	46,6
102	-	32,1	48,0	-	-	-	-	46,2
106	-	29,9	46,8	-	-	-	-	44,6
110	-	27,8	45,4	-	-	-	-	42,9
114	-	25,6	44,0	-	-	-	-	41,3
116	-	24,6	43,3	-	-	-	-	40,5
118	-	-	42,6	-	-	-	-	39,7
122	-	-	41,3	-	-	-	-	38,1
126	-	-	39,9	-	-	-	-	36,4
130	-	-	38,5	-	-	-	-	34,8
131	-	-	38,1	-	-	-	-	34,4
133	-	-	37,4	35,9	-	-	-	-
134	-	-	37,1	35,7	-	-	-	-
136	-	-	36,4	35,2	-	-	-	-
138	-	-	-	34,7	-	-	-	-
142	-	-	-	32,4	-	-	-	-
146	-	-	-	29,9	-	-	-	-
150	-	-	-	27,7	-	-	-	-
154	-	-	-	25,7	-	-	-	-

0 t 280 t 400 t 520 t 640 t 720 t 800 t

6 m steps of luffing jib is standard · 6 m Stufung der Wippe ist Standard · Des paliers de 6 m sont de série pour la fléchette · Falcone standard con sezioni di 6 m · Incrementos de 6 m para plumín abatible son estándar · Lances de 6 m da lança auxiliar como padrão · 6 м шаг размера гуська является стандартом

* Main boom angle 88° · Hauptauslegerwinkel 88° · Jarret de flèche principale 88° · Inclinazione braccio base 88° · Ángulo de pluma principal 88° · Ángulo da lança principal 88° · Угол подъема гл. стрелы 88°

Main boom angle 88°, 85°, 75°, 65°, 55° and 45°; capacities for intermediate boom positions are calculated by the crane control system IC-1 · Hauptauslegerwinkel 88°, 85°, 75°, 65°, 55° und 45°; Traglasten für Zwischenstellungen des Hauptauslegers werden von der Kransteuerung IC-1 berechnet

Jarret de flèche principale 88°, 85°, 75°, 65°, 55° et 45°; le système de commande de la grue IC-1 calcule les charges pour les positions intermédiaires de la flèche

Inclinazione braccio base 88°, 85°, 75°, 65°, 55° e 45°; capacità per posizioni intermedie del braccio sono calcolate dal sistema di controllo della gru IC-1

Ángulo de pluma principal 88°, 85°, 75°, 65°, 55° y 45° las capacidades para posiciones de pluma intermedias son calculadas por el sistema de control de grúa IC-1

Ángulos da lança principal 88°, 85°, 75°, 65°, 55° e 45°; as capacidades para posições da lança intermediária são calculadas pelo sistema de controle da grua IC-1

Грузоподъемность при углах подъема главной стрелы 88°, 85°, 75°, 65°, 55° и 45°, грузоподъемность в промежуточных положениях стрелы рассчитывается системой управления краном IC-1

295 t + 60 t		19-30 m		10,5 m		9.8 m/s		360°		ISO	
120 m + 120 m		SWSL						SFSL			
0 t		0 t - 800 t									
88°/85°		88°/85°		75°		65°		55°		45°	
m	t	t	t	t	t	t	t	t	t	t	t
49	-	36,0*	-	-	-	-	-	-	-	-	-
50	-	35,7*	-	-	-	-	-	-	-	-	-
54	-	33,9*	-	-	-	-	-	-	-	-	-
58	-	31,9*	-	-	-	-	-	-	-	-	-
60	-	39,7	-	-	-	-	-	-	-	40,2	-
62	-	38,9	-	-	-	-	-	-	-	40,2	-
66	-	37,5	-	-	-	-	-	-	-	39,8	-
70	-	35,8	-	-	-	-	-	-	-	39,4	-
74	-	34,1	-	-	-	-	-	-	-	39,0	-
78	-	32,3	-	-	-	-	-	-	-	38,5	-
80	-	31,3	-	-	-	-	-	-	-	38,2	-
82	-	30,3	-	-	-	-	-	-	-	37,8	-
86	-	28,4	-	-	-	-	-	-	-	36,9	-
90	-	26,5	-	-	-	-	-	-	-	36,1	-
94	-	24,6	-	-	-	-	-	-	-	35,2	-
98	-	22,7	-	-	-	-	-	-	-	34,4	-
101	-	21,3	33,9	-	-	-	-	-	-	33,3	-
102	-	20,8	33,8	-	-	-	-	-	-	33,0	-
103	-	20,4	33,6	-	-	-	-	-	-	32,7	-
106	-	-	33,2	-	-	-	-	-	-	31,7	-
110	-	-	32,4	-	-	-	-	-	-	30,3	-
114	-	-	31,5	-	-	-	-	-	-	29,0	-
118	-	-	30,5	-	-	-	-	-	-	27,6	-
122	-	-	29,5	-	-	-	-	-	-	26,3	-
126	-	-	28,5	-	-	-	-	-	-	24,9	-
130	-	-	27,4	-	-	-	-	-	-	23,6	-
134	-	-	26,3	-	-	-	-	-	-	22,2	-
138	-	-	25,2	-	-	-	-	-	-	20,9	-
139	-	-	24,9	-	-	-	-	-	-	20,6	-
141	-	-	24,4	21,9	-	-	-	-	-	-	-
142	-	-	24,2	21,8	-	-	-	-	-	-	-
146	-	-	23,1	20,7	-	-	-	-	-	-	-
147	-	-	22,8	20,1	-	-	-	-	-	-	-
148	-	-	22,6	-	-	-	-	-	-	-	-

0 t 280 t 400 t 520 t 640 t 720 t 800 t

6 m steps of luffing jib is standard · 6 m Stufung der Wippe ist Standard · Des paliers de 6 m sont de série pour la fléchette · Falcone standard con sezioni di 6 m · Incrementos de 6 m para plumín abatible son estándar · Lances de 6 m da lança auxiliar como padrão · 6 м шаг размера гуська является стандартом

* Main boom angle 88° · Hauptauslegerwinkel 88° · Jarret de flèche principale 88° · Inclinazione braccio base 88° · Ángulo de pluma principal 88° · Ángulo da lança principal 88° · Угол подъема гл. стрелы 88°

Main boom angle 88°, 85°, 75°, 65°, 55° and 45°; capacities for intermediate boom positions are calculated by the crane control system IC-1
Hauptauslegerwinkel 88°, 85°, 75°, 65°, 55° und 45°; Traglasten für Zwischenstellungen des Hauptauslegers werden von der Kransteuerung IC-1 berechnet

Jarret de flèche principale 88°, 85°, 75°, 65°, 55° et 45°; le système de commande de la grue IC-1 calcule les charges pour les positions intermédiaires de la flèche

Inclinazione braccio base 88°, 85°, 75°, 65°, 55° e 45°; capacità per posizioni intermedie del braccio sono calcolate dal sistema di controllo della gru IC-1

Ángulo de pluma principal 88°, 85°, 75°, 65°, 55° y 45° las capacidades para posiciones de pluma intermedias son calculadas por el sistema de control de grúa IC-1

Ângulos da lança principal 88°, 85°, 75°, 65°, 55° e 45°; as capacidades para posições da lança intermediária são calculadas pelo sistema de controle da grua IC-1

Грузоподъемность при углах подъема главной стрелы 88°, 85°, 75°, 65°, 55° и 45°, грузоподъемность в промежуточных положениях стрелы рассчитывается системой управления краном IC-1

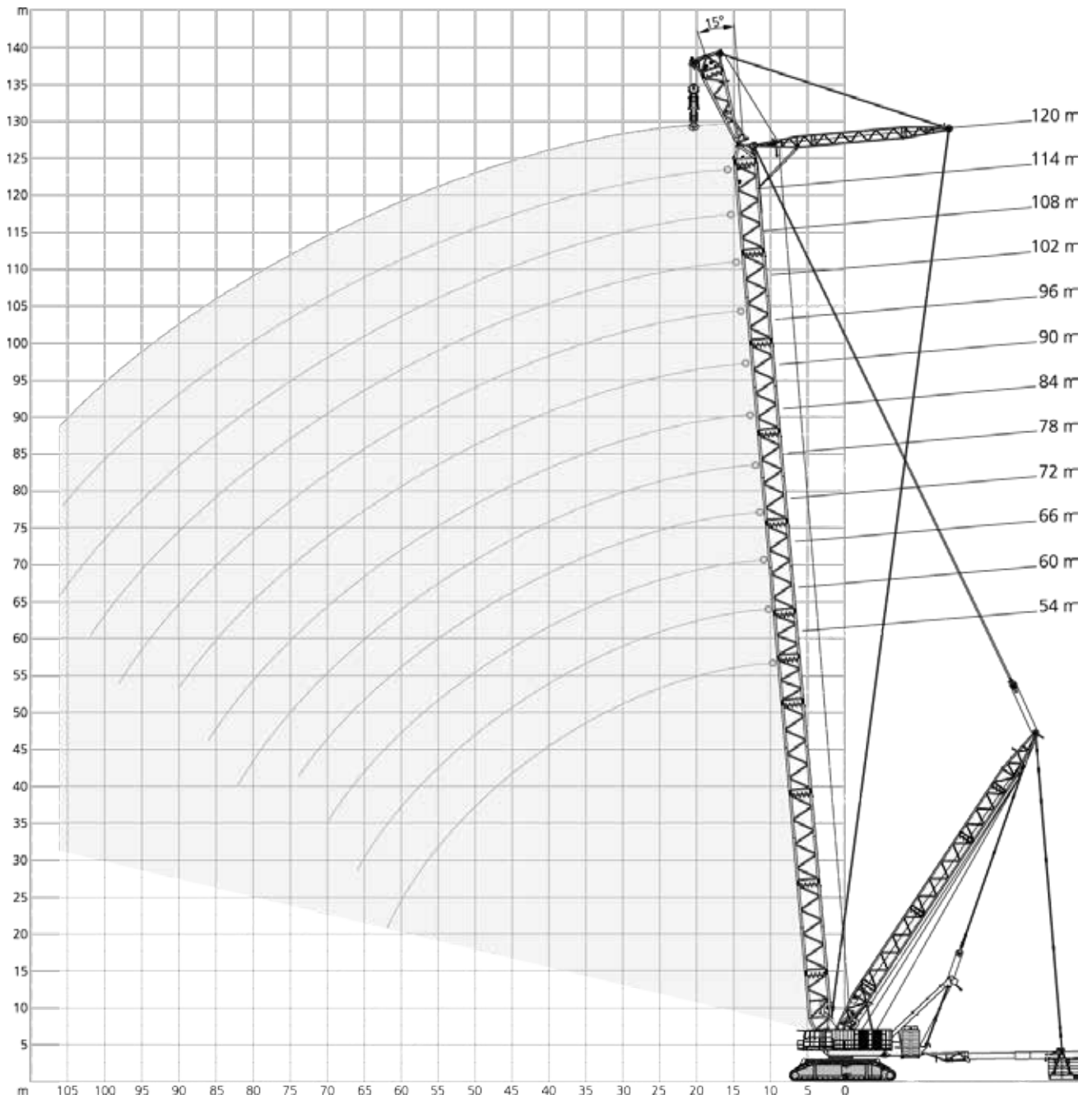

m	t	t	t	t	t	t	t	t	t	t	t	t	t	m
14	1071,0	-	-	-	-	-	-	-	-	-	-	-	-	14
16	1007,0	983,0	972,0	876,0	793,0	-	-	-	-	-	-	-	-	16
18	951,0	934,0	972,0	876,0	793,0	710,0	637,0	572,0	-	-	-	-	-	18
20	901,0	890,0	946,0	876,0	793,0	710,0	637,0	572,0	516,0	464,0	410,0	-	-	20
21	879,0	870,0	925,0	876,0	793,0	710,0	637,0	572,0	516,0	464,0	410,0	366,0	-	21
22	857,0	850,0	904,0	876,0	793,0	710,0	637,0	572,0	516,0	464,0	410,0	366,0	-	22
24	817,0	814,0	866,0	855,0	793,0	710,0	637,0	572,0	516,0	464,0	409,0	365,0	-	24
26	781,0	781,0	831,0	831,0	771,0	707,0	637,0	572,0	516,0	464,0	409,0	365,0	-	26
28	748,0	751,0	798,0	801,0	764,0	700,0	634,0	572,0	516,0	464,0	408,0	364,0	-	28
30	718,0	723,0	751,0	745,0	739,0	689,0	630,0	570,0	515,0	464,0	408,0	363,0	-	30
34	663,0	657,0	651,0	645,0	639,0	633,0	623,0	563,0	513,0	461,0	402,0	359,0	-	34
38	584,0	578,0	572,0	566,0	560,0	554,0	549,0	543,0	507,0	459,0	396,0	353,0	-	38
42	510,0	514,0	508,0	502,0	496,0	490,0	484,0	478,0	473,0	438,0	389,0	346,0	-	42
46	438,0	462,0	455,0	449,0	443,0	437,0	431,0	425,0	419,0	413,0	376,0	336,0	-	46
50	377,0	406,0	409,0	403,0	397,0	391,0	386,0	380,0	374,0	368,0	363,0	325,0	-	50
54	334,0	352,0	371,0	365,0	358,0	352,0	347,0	341,0	335,0	329,0	347,0	314,0	-	54
58	291,0	305,0	326,0	331,0	325,0	319,0	313,0	307,0	302,0	295,0	330,0	300,0	-	58
62	245,0	273,0	284,0	300,0	297,0	290,0	285,0	278,0	273,0	266,0	297,0	288,0	-	62
66	-	237,0	246,0	263,0	272,0	265,0	259,0	253,0	247,0	241,0	268,0	260,0	-	66
70	-	-	225,0	229,0	242,0	243,0	237,0	231,0	225,0	219,0	241,0	234,0	-	70
74	-	-	-	201,0	212,0	220,0	218,0	212,0	206,0	199,0	217,0	211,0	-	74
78	-	-	-	-	184,0	194,0	200,0	194,0	188,0	182,0	195,0	189,0	-	78
82	-	-	-	-	166,0	169,0	177,0	179,0	173,0	166,0	175,0	170,0	-	82
86	-	-	-	-	-	147,0	155,0	159,0	159,0	152,0	157,0	152,0	-	86
90	-	-	-	-	-	-	134,0	139,0	142,0	139,0	140,0	136,0	-	90
94	-	-	-	-	-	-	-	120,0	124,0	125,0	128,0	121,0	-	94
98	-	-	-	-	-	-	-	105,0	108,0	109,0	115,0	110,0	-	98
102	-	-	-	-	-	-	-	-	91,5	94,0	101,0	97,5	-	102
106	-	-	-	-	-	-	-	-	-	79,5	88,5	85,5	-	106
110	-	-	-	-	-	-	-	-	-	-	76,0	74,0	-	110
114	-	-	-	-	-	-	-	-	-	-	63,5	62,5	-	114
118	-	-	-	-	-	-	-	-	-	-	-	51,5	-	118
119	-	-	-	-	-	-	-	-	-	-	-	49,2	-	119

340 t
440 t
540 t
640 t
720 t
800 t

Crawler Carrier

5-section carrier comprising car body, two cross axles and two split-type crawler side frames.
Car body, cross axles and side frames are pin-connected hydraulically.
Track width: 10.5 m.

Car body	Bending- and torsion-resistant welded structure fabricated from high-strength fine grain structural steel. Quick-disconnect fittings (optional) facilitate removal of slew ring from car body to minimise weight for transportation.
Cross axles	Bending- and torsion-resistant welded structure fabricated from high-strength fine grain structural steel incl. hydraulic jack legs.
Crawler side frames	Bending- and torsion-resistant welded structure fabricated from high-strength fine grain structural steel. Split-type side frames to minimise weight for transportation. Centralised lubrication included as standard.
Crawlers	Crawler pads made of heat-treated high-strength cast steel. 15 rollers per crawler with hardened rolling surfaces.
Drive	The crawlers are each driven by two hydraulic motors through closed planetary gear reduction units running in oil bath, equipped with spring loaded, hydraulically released holding brakes. Each crawler provides independent, infinitely variable control and counter-rotation capability. Quadro-Drive as standard.
Slew unit	Four slew gearboxes in car body powered by hydraulic motors through closed planetary gear units running in oil bath. Spring loaded, hydraulically released holding brake and non-wearing hydraulic braking.

Superstructure

Counterweight	295 t in combination with 60 t central ballast.
Frame	Torsion-resistant welded structure fabricated from high-strength fine grain structural steel. Longitudinal beam construction to accommodate three rope drums and boom hoist. Split-type superstructure for ease of transportation.
Power and control module	Two independent drive units incl. pump transfer gearbox and pumps are contained in a separate module which is connected to the side of the superstructure. Power comes from two Mercedes-Benz diesel engine type OM 471 LA. Output: 390 kW (523 HP) at 1700 1/min, torque 2460 Nm at 1300 1/min each. The engine complies with emission standard EU Stage IV / EPA Tier 4f regulations. The system is equipped with Ad-Blue and a SCR catalytic converter. Optional for non-regulated markets: Mercedes-Benz diesel engine type OM 502 LA. Output: 390 kW (523 HP) at 1800 1/min, torque 2400 Nm at 1300 1/min each. The engine complies with emission standard EU Stage III A / EPA Tier 3 regulations. Pump transfer gearbox with five variable displacement axial piston pumps and gear pumps. The power and control module includes cabin, complete electrics and electric generators as standard. Fuel tank capacity: 2000 l.
Rope drums	Standard superstructure equipment includes three rope drums – hoist 1, hoist 2 and boom hoist. Rope drums powered through closed planetary gear units running in oil bath. All rope drums have hydraulically released multi-disc brakes and non-wearing hydraulic braking for load lowering. Rope ends of all drums provided with quick-connect rope end fittings. Hydraulically pinned hoists H1 and H2 (optional H3) can be removed in order to minimise weight for transportation.
Control system	IC-1: Electronic proportional valve pilot control integrated in stored-program control system incl. diagnostic. Two multi-color monitors, load indicator operated via a touch screen. Working speeds infinitely variable controlled by the lever position. Automatic power control for optimal utilisation of engine output. Standard working range limitation and ground pressure indicator.
Cabin	Spacious comfortable cab located at front end of power module. Large laminated glass for front and roof windows, computerised air conditioner as standard and self-contained hot air heater. Front console includes instrumentation and crane controls as well as two graphic displays. It can be tilted back, together with the operator seat, for an improved operator view of the boom point. Camera systems for monitoring the rope drums and SL ballast, hour meter, load moment indicator, two working lights, storage cabinets and refrigerator are included as standard.
Electrical equipment	24 V system (2 batteries 12 V / 180 Ah). 3-phase alternator 24 V, 80 A. Plus 3-phase generator 400 V 50 Hz 20 kVA for air conditioner, heater, lighting and multiple use on the job site. Emergency generator 400 V 50 Hz 16 kVA.
Quick-connection	Hydraulic quick-disconnect fittings on superstructure and carrier as standard.

Boom Configurations

General	Tubular chord lattice structure fabricated from high-strength fine grain structural steel. Walkways on boom, jib and mast. Hydraulic pinning.
SSL	Main boom: foot section 10 m, inserts 6 m and 12 m, boom head 2 m with 2 sheave-sets. Superlift equipment. Main boom lengths: 54-120 m.
HSSL	Main boom: Using the heavy sections of main boom SSL 108 m. Superlift equipment. Main boom lengths: 48-84 m.
SSL / LSL (SGL 108 m)	Main boom: foot section 10 m, inserts 6 m and 12 m, extended by jib inserts 6 m and 12 m, heavy-lift top 2 m with 1 sheave-set from main boom SSL. Superlift equipment. Main boom lengths: 114-156 m.
SSL / LSL+LF S2	Main boom: foot section 10 m, inserts 6 m and 12 m, extended by jib inserts 6 m and 12 m, heavy-lift top 2 m with 1 sheave-set from main boom SSL. Fixed fly jib: foot section 9 m, jib top section 9 m. Jib length: 18 m. Main boom lengths: 114-144 m. Offset: 20°.
SWSL	Main boom: same as SSL. Offset 88° to 45°. Luffing fly jib: foot section 10 m, inserts 6 m and 12 m, heavy-lift top 2 m with 1 sheave-set from main boom SSL. Superlift equipment. Main boom lengths: 54-120 m. Jib lengths: 36-120 m.
SFSL	Same as SWSL. Offset fly jib 15°.
SFVL	Main boom: same as SSL. Fixed fly jib: foot section 10 m, heavy-lift top 2 m with 2 sheave-sets from main boom SSL. Superlift equipment. Main boom lengths: 54-120 m. Jib length: 12 m. Offset: 15°.
Pinning of boom	Hydraulic assisted pinning of boom sections as standard.
Reeving winch	Mounted on superstructure as standard.
Operator aids	Electronic load indicator, hoist limit switch, limit switches for boom movements, hydraulic boom back-stops, anemometer.

Superlift Configurations

Tele-SL	Mast 50 m (type 2621), counterweight tray 640 t or 800 t or counterweight carrier for max. 640 t optional. Superlift radius infinitely variable during operation: 19 m to 25 m with a mast radius of 22 m and 24 m to 30 m with a mast radius of 26.4 m.
----------------	--

Optional Equipment

Counterweight carrier	The counterweight carrier with a max. total weight of 640 t is adjustable from 19 m to 25 m or from 24 m to 30 m from the centre of rotation, and can be operated in the circular path, trailing and $\pm 30^\circ$ parallel travel modes. Deadweight 130 t, strips down to three components for easy transport.
Superlift counterweights	
Runner equipment 3 m – 70 t	For 2 lines, mounted on main boom or jib heads. Distance to sheave set in steep boom position approx. 1.3 m. Lifting capacity: max. 70 t.
Hoist H3	Mounted on superstructure.
Fire suppression system	Automatic fire suppression system incl. shutters at container.
Fire detection system	Detection only.
Bunk bed in cabin	Foldable bunk-bed.
Folding seats in cabin	Two folding sets in cabin.
Fall protection	For main boom, jib and SL mast.
800 t Superlift-Tray	
Boom Booster Kit	Details on request.
TWIN Kit	Details on request.

Raupenunterwagen

Der Raupenunterwagen ist 5-teilig und besteht aus einem Mittelstück, zwei Querträgern und zwei geteilten Raupenträgern. Raupenträger, Mittelstück und Querträger werden hydraulisch verbolzt. Die Spurbreite beträgt 10,5 m.

Mittelstück	Biege- und verwindungssteife Schweißkonstruktion aus hochfestem Feinkornbaustahl. Die Rollendrehverbindung sitzt am Mittelstück und ist mit Schnellspannmutter (optional) auf einfache Weise zur Reduzierung des Transportgewichtes lösbar.
Querträger	Biege- und verwindungssteife Schweißkonstruktion aus hochfestem Feinkornbaustahl mit hydraulischer Abstützung.
Raupenträger	Biege- und verwindungssteife Schweißkonstruktion aus hochfestem Feinkornbaustahl. Geteilter Raupenträger zur Minimierung der Transportgewichte. Zentralschmieranlage serienmäßig.
Raupen	Bodenplatten der Raupenkettens aus vergütetem hochfesten Stahlguss. 15 Laufrollen je Raupe mit gehärteten Laufflächen.
Antrieb	Die Raupen werden von je zwei Hydromotoren über geschlossene, ölbadgeschmierte Planetengetriebe mit federbelasteten, hydraulisch gelüfteten Haltebremsen angetrieben. Jede Seite ist stufenlos, einzeln und gegenläufig steuerbar. Quadro-Antrieb serienmäßig.
Drehwerk	Vier Drehwerke im Mittelstück mit Antrieb durch Hydromotor über geschlossenes, ölbadgeschmiertes Planetengetriebe. Federbelastete, hydraulisch gelüftete Haltebremse und verschleißfreie hydraulische Bremsung.

Oberwagen

Gegengewicht	295 t in Verbindung mit 60 t Zentralballast.
Rahmen	Verformungssteife Schweißkonstruktion aus hochfestem Feinkornbaustahl. Die Längsträgerkonstruktion dient der Aufnahme von drei Winden und dem Einziehwerk. Aus Transportgründen ist der Oberwagen geteilt ausgeführt.
Antriebsmodul	<p>Zwei unabhängige Antriebseinheiten, einschließlich Pumpenverteilergetriebe und Pumpen, befinden sich in einem separaten Modul, das mit der Seite des Oberwagens verbunden ist. Die Leistung liefern zwei Mercedes-Benz-Dieselmotoren vom Typ OM 471 LA. Ausgang: jeweils 390 kW (523 PS) bei 1700 1/min, Drehmoment 2460 Nm bei 1300 1/min. Der Motor entspricht der Emissionsnorm EU Stage IV / EPA Tier 4f. Das System arbeitet mit Ad-Blue und einem SCR-Katalysator.</p> <p>Optional für nicht-regulierte Märkte: Mercedes-Benz-Dieselmotor, Typ OM 502 LA. Ausgang: jeweils 390 kW (523 PS) bei 1800 1/min, Drehmoment 2400 Nm bei 1300 1/min. Der Motor entspricht der Emissionsnorm EU Stage III A / EPA Tier 3.</p> <p>Pumpenverteilergetriebe mit fünf verstellbaren Axialkolbenpumpen und zusätzlichen Zahnradpumpen. Im Antriebsmodul sind serienmäßig die Kabine, die gesamte Elektrik sowie die Stromerzeuger integriert. Kraftstoffbehälter: 2000 l.</p>
Seilwinden	Der Oberwagen ist serienmäßig mit drei Seilwinden – Hubwerk 1, Hubwerk 2 und Einziehwerk – ausgerüstet. Der Antrieb der Winden erfolgt über geschlossene, ölbadgeschmierte Planetengetriebe. Alle Seilwinden sind mit, hydraulisch gelüfteten Lamellenbremsen und verschleißfreier hydraulischer Bremsung für den Senkvorgang ausgerüstet. Die Seilenden aller Winden sind mit Pressfitting und Taschen ausgestattet. Zur Reduzierung der Transportgewichte können die hydraulisch verbolzten Winden H1 und H2 (optional H3) ausgebaut werden.
Steuerung	IC-1: Elektronische Proportionalventilvorsteuerung integriert in eine speicherprogrammierte Steuerung mit Fehlerdiagnose. Zwei Farbbildschirme, Bedienung über Touchscreen. Die Arbeitsgeschwindigkeiten werden durch die Hebelstellung stufenlos geregelt. Leistungsregelung der Antriebe zur optimalen Ausnutzung der Motorleistung. Serienmäßig Arbeitsbereichsbegrenzung und Anzeige der Bodenpressung.
Kabine	Die geräumige Komfortkabine ist im vorderen Bereich des Antriebsmoduls angeordnet. Sie ist mit großzügiger Sicherheitsverglasung auch im Dachbereich, computergesteuerter Klimaanlage serienmäßig und motorunabhängiger Warmluftheizung ausgestattet. Steuer- und Kontrollelemente für die Kranfunktionen sowie zwei Grafik-Displays befinden sich in der Frontkonsole. Diese ist zur Sichtverbesserung gemeinsam mit dem Fahrersitz nach hinten neigbar. Kamerasysteme für die Überwachung von Winden und SL-Ballast, Betriebsstundenzähler, Lastmomentanzeige, zwei Arbeitsscheinwerfer, Ablageschränke und Kühlschränke serienmäßig.
Elektrische Anlage	24 V System (2 x Batterie 12 V / 180 Ah). 3-Phasen Wechselstromgenerator 24 V, 80 A. Zusätzlich 3-Phasengenerator 400 V 50 Hz 20 KVA für Klimaanlage, Heizung, Beleuchtung und vielfältige Anwendungen auf der Baustelle. Notstromaggregat 400 V 50 Hz 16 KVA.
Schnellverbindung	Hydraulische Schnellverbindung Oberwagen / Unterwagen serienmäßig.

Auslegervarianten

Allgemein	Gitter-Rohrkonstruktion aus hochfestem Feinkornbaustahl. Begehungen auf Hauptausleger, Hilfsausleger und Superlift-Mast. Hydraulisch verbolzbar.
SSL	Hauptausleger: Fußstück 10 m, Zwischenstücke 6 m und 12 m, Anschlusskopf 2 m mit 2 Rollensätzen. Superlift-Einrichtung. Hauptauslegerlängen: 54-120 m.
HSSL	Hauptausleger: Unter Verwendung der schweren Komponenten des Hauptauslegers SSL 108 m. Superlift-Einrichtung. Hauptauslegerlängen: 48-84 m.
SSL / LSL (SGL 108 m)	Hauptausleger: Fußstück 10 m, Zwischenstücke 6 m und 12 m, verlängert um Hilfsauslegerzwischenstücke 6 m und 12 m, Schwerlastkopf 2 m mit 1 Rollensatz vom Hauptausleger SSL. Superlift-Einrichtung. Hauptauslegerlängen: 114-156 m.
SSL / LSL+LF S2	Hauptausleger: Fußstück 10 m, Zwischenstücke 6 m und 12 m, verlängert um Hilfsauslegerzwischenstücke 6 m und 12 m, Schwerlastkopf 2 m mit 1 Rollensatz vom Hauptausleger SSL. Starrer Hilfsausleger: Fußstück 9 m, Spitze 9 m. Hilfsauslegerlänge: 18 m. Hauptauslegerlängen: 114-144 m. Vorneigung: 20°.
SWSL	Hauptausleger: wie SSL. Vorneigung 88° bis 45°. Wippbarer Hilfsausleger: Fußstück 10 m, Zwischenstücke 6 m und 12 m, Schwerlastkopf 2 m mit 1 Rollensatz vom Hauptausleger SSL. Superlift-Einrichtung. Hauptauslegerlängen: 54-120 m. Hilfsauslegerlängen: 36-120 m.
SFSL	Wie SWSL. Vorneigung des Hilfsauslegers: 15°.
SFVL	Hauptausleger: wie SSL. Starrer Hilfsausleger: Fußstück 10 m, Schwerlastkopf 2 m mit 2 Rollensätzen vom Hauptausleger SSL. Superlift-Einrichtung. Hauptauslegerlängen: 54-120 m. Hilfsauslegerlänge: 12 m. Vorneigung: 15°.
Auslegerverbolzung	Serienmäßig hydraulische verbolzbare Auslegerteile.
Einscherwinde	Serienmäßig am Oberwagen angebaut.
Sicherheitseinrichtungen	Elektronischer Lastmomentbegrenzer, Hubendschalter, Endschalter für Auslegerbewegungen, hydraulische Ausleger-Rückfallsicherungen, Windmesser.

Superlift-Konfigurationen

Tele-SL	Mast 50 m (Typ 2621), Gegengewichtstraverse 640 t oder 800 t oder optional Gegengewichtswagen mit max. 640 t. Superlift-Radius stufenlos im Betrieb verstellbar von 19 m bis 25 m bei Mastradius 22 m und von 24 m bis 30 m bei Mastradius 26,4 m.
----------------	--

Zusatzrüstung

Gegengewichtswagen	Der Gegengewichtswagen mit max. 640 t Gesamtgewicht kann von 19 m bis 25 m bzw. 24 m bis 30 m zur Drehmitte frei verstellt und in den Fahrzuständen Drehen, Hinterherfahrt und Nachlauf $\pm 30^\circ$ betrieben werden. Eigengewicht 130 t, zum Transport in drei Komponenten zerlegbar.
Superlift-Gegengewichte	
Runner 3 m – 70 t	Für 2 Seile, Anbau an Haupt- oder Hilfsauslegerkopf. Abstand zu Rollensatz bei Auslegerstellung ca. 1,3 m. Tragfähigkeit: max. 70 t.
Hubwerk H3	Wird im Oberwagen eingebaut.
Brandschutzsystem	Automatisches Brandschutzsystem mit Verschlussklappen in Containerwänden.
Brandmeldesystem	Nur Brandmeldung.
Schlafgelegenheit in der Kabine	Klappbett.
Klappsitze in der Kabine	Zwei Klappsitze in der Kabine.
Absturzsicherung	Für Hauptausleger, Hilfsausleger und SL-Mast.
800 t Superlift-Traverse	
Ausleger-Boosterkit	Einzelheiten auf Anfrage.
TWIN-Kit	Einzelheiten auf Anfrage.

Châssis à chenilles

Le porteur à chenilles est réalisé en 5 parties et se compose d'une partie centrale, de deux traverses et de deux trains de chenilles divisibles en deux parties. Les trains de chenilles, la partie centrale et les traverses sont verrouillés hydrauliquement.

La voie est de 10,5 m.

Partie centrale

Structure mécano-soudée rigide à la flexion et à la torsion, réalisée en acier de construction à grains fins à haute résistance. Ecrous à serrage rapide (en option) facilitant le démontage de la couronne d'orientation pour réduire les poids de transport.

Traverses

Structure mécano-soudée rigide à la flexion et à la torsion, réalisée en acier de construction à grains fins à haute résistance, avec calage hydraulique.

Trains de chenille

Structure mécano-soudée rigide à la flexion et à la torsion, réalisée en acier de construction à grains fins à haute résistance. Trains de chenilles divisibles pour minimiser les poids de transport. Graissage centralisé en série.

Chenilles

Patins de chenilles en acier coulé trempé et revenu à haute résistance. 15 galets par chenille avec surfaces de roulement trempées.

Entraînement

Les chenilles sont entraînées chacune par deux moteurs hydrauliques avec réducteurs planétaires en carter étanche sous bain d'huile, munis de freins d'arrêt à ressorts à desserrage hydraulique. Chaque côté permet un mouvement réglable sans paliers individuel et dans le sens opposé. Entraînement quadro en série.

Mécanisme d'orientation

Quatre mécanismes d'orientation dans la partie centrale entraînés par moteurs hydrauliques avec réducteurs planétaires en carter étanche sous bain d'huile. Freins d'arrêt à ressorts à desserrage hydraulique et freinage anti-usure hydraulique.

Partie supérieure

Contrepoids

295 t en combinaison avec 60 t de lest central.

Charpente

Structure mécano-soudée résistant à la déformation, réalisée en acier de construction à grains fins à haute résistance. Structure à longerons servant à recevoir trois treuils et le mécanisme de relevage. La partie supérieure est divisible en deux parties pour des raisons de transport.

Motorisation et module de commande

Deux unités d'entraînement indépendantes (avec pompes et boîte de transfert) sont intégrées à un module distinct connecté sur le côté de la tourelle. Deux moteurs diesel Mercedes-Benz type OM 471 LA délivrent la puissance nécessaire. Puissance : 390 kW (523 HP) à 1700 tr/mn, couple de 2460 Nm à 1300 tr/mn chacun. Le moteur satisfait au norme EU Stage IV / EPA Tier 4f en matière d'émissions. Le système est équipé d'un convertisseur catalytique Ad-Blue et RCS.

En option pour les marchés non-régulés : Moteur diesel Mercedes-Benz type OM 502 LA. Puissance : 390 kW (523 HP) à 1800 tr/mn, couple de 2400 Nm à 1300 tr/mn chacun. Le moteur satisfait au norme EU Stage III A / EPA Tier 3 en matière d'émissions.

Boîte de transfert avec cinq pompes à cylindrée variable et à pistons axiaux et pompes à engrenages. La cabine, tout le système électrique et les équipements de génération de courant sont logés de série dans le module de motorisation et de commande. Réservoir de carburant : 2000 l.

Treuils

La partie supérieure est équipée de série de trois treuils – le treuil 1, le treuil 2 et le mécanisme de relevage. L'entraînement des treuils s'effectue avec réducteurs planétaires en carter étanche sous bain d'huile. Tous les treuils sont équipés de freins à disques multiples à ressorts à desserrage hydraulique et d'un freinage anti-usure hydraulique pour la descente. Les extrémités des câbles de tous les treuils sont munies des attaches à jonction rapide. Les treuils H1 et H2 (H3 en option) verrouillés hydrauliquement peuvent être déposés pour réduire le poids au transport.

Commande

IC-1 : Pilotage électronique de soupapes proportionnels intégré dans un automate programmable avec diagnostic de dysfonctionnement. Deux écrans couleur, commande du C.E.C. par écran tactile. Les vitesses de travail sont réglées sans paliers par la position du levier. Régulation automatique pour une exploitation optimale de la puissance du moteur. Limitation de portée et force de pression sur base en série.

Cabine

La cabine spacieuse et confortable est placée à la partie avant du module de motorisation et de commande. Large pare-brise et toit en vitrage blindé, climatisation commandée par ordinateur de série et chauffage à air chaud indépendant du moteur. Console frontale avec éléments de commande et de contrôle pour les fonctions de la grue ainsi que deux affichages graphiques. Cette console est inclinable en arrière avec le siège conducteur, assurant au grutier une visibilité optimale. Systèmes de caméra pour surveiller les treuils et lest SL, compteur d'heures de service, affichage du moment de charge, 2 projecteurs de travail, armoires de rangement et réfrigérateur livrés en série.

Installation électrique

Système 24 V (2 batteries 12 V / 180 Ah).
Génératrice à courant alternatif triphasé 24 V, 80 A.
Génératrice triphasée supplémentaire à 400 V 50 Hz 20 kVA pour la climatisation, le chauffage, l'éclairage et de multiples applications sur le chantier.
Groupe électrogène de secours 400 V 50 Hz 16 kVA.

Connexion rapide

Connexion rapide hydraulique entre partie supérieure et châssis en série.

Combinaisons de flèche

Général	Construction tubulaire treillie en acier de haute résistance à grains fins. Passerelles sur flèche principale, volée variable et mât superlift. Verrouillage hydraulique.
SSL	Flèche principale : pied 10 m, tronçons 6 m et 12 m, tête de flèche 2 m avec 2 jeux de poulies. Équipement Superlift. Longueurs de flèche principale : 54-120 m.
HSSL	Flèche principale : Avec utilisation des composants lourds de la flèche principale SSL 108 m. Équipement Superlift. Longueurs de flèche principale : 48-84 m.
SSL / LSL (SGL 108 m)	Flèche principale : pied 10 m, tronçons 6 m et 12 m, allongée de tronçons de fléchette 6 m et 12 m, tête pour charges lourdes 2 m avec 1 jeu de poulie de flèche principale SSL. Équipement Superlift. Longueurs de flèche principale : 114-156 m.
SSL / LSL+LF S2	Flèche principale : pied 10 m, tronçons 6 m et 12 m, allongée de tronçons de fléchette 6 m et 12 m, tête pour charges lourdes 2 m avec 1 jeu de poulie de flèche principale SSL. Fléchette fixe : pied 9 m, sommet de la fléchette 9 m. Longueur de volée variable : 18 m. Longueurs de flèche principale : 114-144 m. Inclinaison : 20°.
SWSL	Flèche principale : idem SSL. Inclinaison 88° à 45°. Fléchette à volée variable : pied 10 m, tronçons 6 m et 12 m, tête pour charges lourdes 2 m avec 1 jeu de poulie de flèche principale SSL. Équipement Superlift. Longueurs de flèche principale : 54-120 m. Longueurs de volée variable : 36-120 m.
SFSL	Idem SWSL. Inclinaison de fléchette : 15°.
SFVL	Flèche principale : idem SSL. Fléchette fixe : pied 10 m, tête pour charges lourdes 2 m avec 2 jeux de poulies de flèche principale SSL. Équipement Superlift. Longueurs de flèche principale : 54-120 m. Longueur de volée variable : 12 m. Inclinaison : 15°.
Boulonnement de flèche	Boulonnement hydraulique des intercalaires de flèche en série.
Tambour de mouflage	Monté sur la partie supérieure en série.
Sécurités	Contrôleur d'état de charge électronique, contacteur de fin de course haut, limiteurs de mouvements de la flèche, retenues hydrauliques anti-basculement de la flèche, anémomètre.

Combinaisons Superlift

Tele-SL	Mât 50 m (type 2621), panier du contrepoids 640 t ou 800 t ou chariot contrepoids en option avec max. 640 t. Rayon du Superlift variable de 19 m à 25 m pour un rayon de mât 22 m et de 24 m à 30 m de pour un rayon de mât 26,4 m.
----------------	---

Équipements optionnels

Chariot contrepoids	Le chariot à contrepoids avec un poids total maxi de 640 t peut être réglé librement entre 19 m et 25 m ou entre 24 m et 30 m du centre de rotation et peut être actionné en modes Orientation, marche arrière et marche en parallèle $\pm 30^\circ$. Poids mort 130 t, démontable en trois parties pour un transport facile.
Contrepoids Superlift	
Équipement potence 3 m – 70 t	Pour 2 lignes, montées sur flèche principale ou têtes de fléchette. Distance au jeu de poulies avec la flèche en position relevée env. 1,3 m. Capacité de levage : max. 70 t.
Treuil H3	Monté sur la partie supérieure.
Système anti-incendie	Système anti-incendie automatique avec clapets coupe-feu automatiques sur conteneur.
Système de détection d'incendie	Détection uniquement.
Lit superposé dans la cabine	Lit superposé rabattable.
Sièges pliant dans la cabine	2 sièges pliant dans la cabine.
Protection antichute	Pour flèche principale, volée variable et mât SL.
Panier Superlift 800 t	
Kit Boom Booster	Plus d'infos sur demande.
Kit TWIN	Plus d'infos sur demande.

Carro cingolato

Carro in 5 sezioni, comprendente corpo centrale, due assali trasversali e due telai portacingoli bicomponente. Il corpo, gli assali trasversali e i telai portacingoli sono collegati idraulicamente mediante spine. Larghezza cingolo: 10,5 m.

Carro	Struttura saldata, resistente a torsioni e flessioni, realizzata in acciaio strutturale pregiato a grana fine. Raccordi rapidi opzionali per facilitare lo smontaggio della ralla dal carro, al fine di ridurre il peso durante il trasporto.
Assali trasversali	Struttura saldata, resistente a torsioni e flessioni, realizzata in acciaio strutturale ad alta resistenza a grana fine, ivi compresi i cilindri idraulici.
Telai portacingoli	Struttura saldata, resistente a torsioni e flessioni, realizzata in acciaio strutturale pregiato a grana fine. Telai portacingoli bicomponente per minimizzare il peso durante il trasporto. Lubrificazione centralizzata di serie.
Cingoli	Pattini realizzati in getto d'acciaio bonificato ad alta resistenza. 15 rulli per cingolo con superficie di rotolamento bonificata.
Azionamento	Ciascuno dei cingoli è azionato da due motori idraulici mediante riduttori planetari in bagno d'olio, muniti di carter a tenuta e freni di arresto a molla, ad apertura idraulica. Ogni cingolo è controllabile in modo indipendente con regolazione in continuo e possibilità di controrotazione. Quadro Drive di serie.
Ralla	I quattro riduttori per la ralla, nel carro, sono azionati da motori idraulici tramite riduttori planetari in bagno d'olio, dotati di carter a tenuta. Freno di arresto a molla, frenatura idraulica antiusura, con apertura idraulica.

Torretta

Contrappeso	295 t in combinazione con una zavorra centrale da 60 t.
Struttura	Struttura saldata resistente a torsioni, realizzata in acciaio strutturale ad alta resistenza a grana fine. Esecuzione con longherone per alloggiare tre tamburi avvolgimento fune e l'organo del braccio. Torretta in due componenti per facilità di trasporto.
Modulo di comando e potenza	Due unità di azionamento indipendenti, con pompe e riduttore di rinvio, contenute in un modulo separato fissato a lato della torretta. L'alimentazione proviene da due motori diesel Mercedes-Benz di tipo OM 471 LA. Potenza erogata: 390 kW (523 HP) a 1700 giri/min, coppia di 2460 Nm a 1300 giri/min ciascuno. Il motore è conforme alle norme standard per le emissioni EU Stage IV / EPA Tier 4f. Il sistema è dotato di Ad-Blue e convertitore catalitico SCR. Opzionale per mercati non regolamentati: Motore diesel Mercedes-Benz di tipo OM 502 LA. Potenza erogata: 390 kW (523 HP) a 1800 giri/min, coppia di 2400 Nm a 1300 giri/min ciascuno. Il motore è conforme alle norme standard per le emissioni EU Stage III A / EPA Tier 3. Riduttore di rinvio per pompa, con cinque pompe a pistoni assiali a cilindrata variabile e pompe a ingranaggi. Il modulo di comando e potenza include di serie i comandi in cabina, tutti i circuiti elettrici e i generatori elettrici. Capacità del serbatoio: 2000 l.
Tamburi avvolgimento fune	La dotazione standard della torretta comprende tre tamburi: argano 1, argano 2 e argano del braccio. I tamburi sono azionati da riduttori planetari in bagno d'olio, dotati di carter a tenuta. Tutti i tamburi sono equipaggiati di freni multidisco, ad apertura idraulica e sistema di frenatura idraulica antiusura per la discesa del carico. Le estremità delle funi di tutti i tamburi sono dotate di raccordi rapidi. Gli argani H1 e H2 (opzionale H3), con fissaggio a mezzo spine e sistema idraulico, possono essere smontati per minimizzare il peso durante il trasporto.
Sistema di comando	IC-1: Valvola di regolazione proporzionale elettronica integrata nel sistema di controllo software, comprendente funzioni di diagnostica. Due monitor a colori, indicatore di carico azionato tramite touch-screen. Velocità di lavoro a regolazione continua sulla base della posizione della leva. Controllo automatico dell'alimentazione, per un utilizzo ottimale della potenza erogata dal motore. Limitatore di sbraccio e indicatore di pressione al suolo di serie.
Cabina	Cabina spaziosa e confortevole, ubicata sul lato anteriore del modulo di potenza. Ampio vetro stratificato per la finestra anteriore e il tetto, climatizzazione computerizzata compresa nella dotazione standard e riscaldatore aria autonomo. La console anteriore comprende la strumentazione e i comandi gru, nonché due display grafici. La cabina può essere inclinata indietro, assieme al sedile dell'operatore, per migliorare la visibilità del punto di lavoro del braccio. Sistemi videocamera per monitoraggio dei tamburi e zavorra SL, contaore, indicatore di carico, due fari di lavoro, vani e frigorifero compresi nella dotazione standard.
Componenti elettrici	Impianto 24 V (2 batterie 12 V / 180 Ah). Alternatore a 3 fasi 24 V, 80 A. Più generatore trifase 400 V 50 Hz 20 kVA per climatizzatore, riscaldatore, illuminazione e altre utenze sul cantiere. Generatore di emergenza 400 V 50 Hz 16 kVA.
Raccordi rapidi	Raccordi rapidi idraulici su torretta e carro di serie.

Configurazioni braccio

Generale	Struttura a traliccio tubolare saldata, resistente a torsioni, realizzata in acciaio strutturale ad alta resistenza a grana fine. Passerelle su braccio base, falcone e colonna. Fissaggio idraulico.
SSL	Braccio base: colonna 10 m, elementi 6 m e 12 m, testa braccio 2 m con 2 gruppi pulegge. Sistema Superlift. Lunghezza del braccio base: 54-120 m.
HSSL	Braccio base: Con le sezioni pesanti del modulo SSL braccio base 108 m. Sistema Superlift. Lunghezza del braccio base: 48-84 m.
SSL / LSL (SGL 108 m)	Braccio base: colonna 10 m, elementi 6 m e 12 m, esteso per elementi falcone 6 m e 12 m, testa heavy-lift 2 m con 1 gruppo pulegge del modulo SSL braccio base. Sistema Superlift. Lunghezza del braccio base: 114-156 m.
SSL / LSL+LF S2	Braccio base: colonna 10 m, elementi 6 m e 12 m, esteso per elementi falcone 6 m e 12 m, testa heavy-lift 2 m con 1 gruppo pulegge del modulo SSL braccio base. Falcone fisso: colonna 9 m, elemento superiore falcone 9 m. Lunghezza falcone: 18 m. Lunghezza del braccio base: 114-144 m. Inclinazione: 20°.
SWSL	Braccio base: come SSL. Inclinazione da 88° a 45°. Falcone a volata variabile: colonna 10 m, elementi 6 m e 12 m, testa heavy-lift 2 m con 1 gruppo pulegge del modulo SSL braccio base. Sistema Superlift. Lunghezza del braccio base: 54-120 m. Lunghezza falcone: 36-120 m.
SFSL	Come SWSL. Inclinazione falcone 15°.
SFVL	Braccio base: come SSL. Falcone fisso: colonna 10 m, testa heavy-lift 2 m con 2 gruppi pulegge del modulo SSL braccio base. Sistema Superlift. Lunghezza del braccio base: 54-120 m. Lunghezza falcone: 12 m. Inclinazione: 15°.
Fissaggio del braccio base	Fissaggio degli elementi del braccio con servocomando idraulico di serie.
Verricello di avvolgimento	Montato su torretta, di serie.
Dispositivi di sicurezza	Indicatore di carico elettronico, finecorsa argano, finecorsa per movimenti braccio, dispositivo antiretro braccio, anemometro.

Configurazioni Superlift

Tele-SL	Colonna 50 m (tipo 2621), telaio contrappesi 640 t o 800 t o contrappeso carro per max. 640 t opzionale. Portata Superlift a variazione infinitesimale durante il funzionamento: da 19 m a 25 m con portata albero di 22 m e da 24 m a 30 m con portata albero di 26,4 m.
----------------	---

Equipaggiamento opzionale

Contrappeso carro	Il carro contrappesi, con un peso max. totale di 640 t, è regolabile da 19 m a 25 m o da 24 m a 30 m dal centro di rotazione e può essere utilizzato in percorso circolare, in posizione posteriore con spostamento laterale di $\pm 30^\circ$ e a traslazione parallela. Carico fisso 130 t, ridotto a tre componenti per facilità di trasporto.
Contrappesi Superlift	
Attrezzatura runner 3 m – 70 t	Per 2 linee, montato su braccio base o teste del falcone. Distanza da gruppo pulegge in posizione verticale circa 1,3 m. Capacità di sollevamento: Max. 70 t.
Argano H3	Montato su torretta.
Sistema antincendio	Sistema antincendio automatico comprensivo di serrande nelle pareti container.
Sistema di rilevazione incendi	Solo rilevazione.
Letto a castello in cabina	Letto a castello pieghevole.
Sedili ripiegabili in cabina	Due set ripiegabili in cabina.
Protezione anticaduta	Per braccio base, falcone e colonna SL.
Telaio Superlift da 800 t	
Kit Boom Booster	Dettagli su richiesta.
Kit TWIN	Dettagli su richiesta.

Chasis de orugas

Chasis de 5 secciones, formado por un cuerpo central, dos ejes transversales y dos bastidores laterales divididos para orugas. El cuerpo central, los ejes transversales y los bastidores laterales están unidos con pernos hidráulicos.
Ancho de oruga: 10,5 m.

Cuerpo central	Estructura soldada resistente a la flexión y a la torsión, fabricada con acero de construcción de grano fino y alta resistencia. Los accesorios de desconexión rápida (opcional) facilitan el desmontaje del anillo de giro del cuerpo central para reducir al mínimo el peso de transporte.
Ejes transversales	Estructura soldada resistente a la flexión y a la torsión, fabricada con acero estructural de grano fino y alta resistencia, incl. patas hidráulicas.
Bastidores laterales de las orugas	Estructura soldada resistente a la flexión y a la torsión, fabricada con acero de construcción de grano fino y alta resistencia. Bastidores laterales divididos para reducir al mínimo el peso de transporte. Lubricación centralizada incluida de serie.
Orugas	Placas de oruga de acero de fundición templado de alta resistencia. 15 rodillos por cada oruga con superficies de rodadura endurecidas.
Tracción	Las orugas están propulsadas por dos motores hidráulicos cada una, a través de unidades reductoras de engranajes planetarios en cárter cerrado y baño de aceite, equipadas con frenos de parada accionados por muelle y soltados hidráulicamente. Cada oruga brinda un control infinitamente variable y capacidad de contrarrotación. Transmisión Quadro de serie.
Mecanismo de giro	Cuatro cajas de engranajes de giro en el cuerpo central son accionadas por motores hidráulicos a través de engranajes planetarios en cárter cerrado y baño de aceite. Freno de parada accionado por muelles y soltado hidráulicamente, y frenado hidráulico sin desgaste.

Superestructura

Contrapesos	295 t en combinación con 60 t de lastre central.
Bastidor	Estructura soldada resistente a la torsión, fabricada con acero estructural de grano fino y alta resistencia. Construcción de viga longitudinal para albergar tres tambores de cable y cabrestante de pluma. Superestructura dividida para facilitar el transporte.
Módulo de propulsión	<p>Dos unidades de propulsión independientes, incl. engranajes de distribución de bombas y bombas se encuentran en un módulo separado conectado al lateral de la superestructura. Potencia proporcionada por dos motores diésel Mercedes-Benz tipo OM 471 LA. Potencia: cada uno 390 kW (523 HP) a 1700 rpm, par motor 2460 Nm a 1300 rpm. El motor cumple con los reglamentos norma de emisión EU Stage IV / EPA Tier 4f. El sistema está equipado con Ad-Blue y un convertidor catalítico SCR.</p> <p>Opcional para mercados no regulados: Motor diésel Mercedes-Benz tipo OM 502 LA. Potencia: cada uno 390 kW (523 HP) a 1800 rpm, par motor 2400 Nm a 1300 rpm. El motor cumple con los reglamentos norma de emisión EU Stage III A / EPA Tier 3.</p> <p>Engranaje de distribución de bombas con cinco bombas de pistón axial de desplazamiento variable y bombas de engranajes adicionales. El módulo de alimentación y control incluye cabina, sistema eléctrico completo y generadores eléctricos de serie. Capacidad del depósito de combustible: 2000 l.</p>
Tambores de cable	El equipamiento de serie de la superestructura incluye tres tambores de cable: cabestrante 1, cabestrante 2 y cabestrante de pluma. Tambores de cable accionados a través de engranajes planetarios en cárter cerrado y baño de aceite. Todos los tambores de cable tienen frenos multidisco soltados hidráulicamente, y frenado hidráulico sin desgaste para reducir el peso. Los extremos de los cables están equipados con accesorios de conexión rápida. Los cabrestantes H1 y H2 (opcional H3) fijados con pernos hidráulicos pueden desmontarse para reducir al mínimo el peso de transporte.
Sistema de control	IC-1: Control piloto electrónico de válvulas proporcionales integrado en un sistema de control por programa almacenado, incluido diagnóstico. Dos monitores multicolor, indicador de carga operado por pantalla táctil. Velocidades de trabajo controladas en progresión continua por la posición de la palanca. Control automático de potencia para un aprovechamiento óptimo de la potencia del motor. Limitación del área de trabajo e indicador de presión sobre el terreno, de serie.
Cabina	Cabina espaciosa y confortable ubicada en la parte frontal del módulo de alimentación. Amplio vidrio laminado para luna delantera y de techo, aire acondicionado computarizado de serie y calefacción autónoma de aire caliente. La consola frontal incluye instrumentos y controles de grúa, así como dos pantallas gráficas. Puede inclinarse hacia atrás, junto con el asiento del operador, para mejorar la visibilidad de manejo de la pluma. Sistemas de cámaras para monitorizar los tambores de cable y el lastre SL, contador de horas, indicador de momento de carga, dos luces de trabajo, armarios de almacenamiento y refrigerador incluidos de serie.
Equipamiento eléctrico	Sistema de 24 V (2 baterías de 12 V / 180 Ah). Alternador de 3 fases de 24 V, 80 A. Además, generador de 3 fases de 400 V 50 Hz, 20 kVA, para aire acondicionado, calefacción, luces y usos múltiples en el lugar de trabajo. Generador de emergencia de 400 V 50 Hz, 16 kVA.
Conexión rápida	Accesorios hidráulicos de desconexión rápida en el chasis y en la superestructura de serie.

Configuraciones de pluma

General	Estructura tubular de celosía fabricada con acero estructural de grano fino y alta resistencia. Pasarelas en pluma, plumín y mástil. Fijación hidráulica.
SSL	Pluma principal: tramo de pie 10 m, tramos intermedios 6 m y 12 m, cabeza de la pluma 2 m con 2 juegos de poleas. Equipamiento Superlift. Longitudes de pluma principal: 54-120 m.
HSSL	Pluma principal: Usando la sección reforzada de pluma principal SSL 108 m. Equipamiento Superlift. Longitudes de pluma principal: 48-84 m.
SSL / LSL (SGL 108 m)	Pluma principal: tramo de pie 10 m, tramos intermedios 6 m y 12 m, extendido con tramos intermedios 6 m y 12 m, cabeza de carga pesada 2 m con 1 juego de poleas desde pluma principal SSL. Equipamiento Superlift. Longitudes de pluma principal: 114-156 m.
SSL / LSL+LF S2	Pluma principal: tramo de pie 10 m, tramos intermedios 6 m y 12 m, extendido con tramos intermedios 6 m y 12 m, cabeza de carga pesada 2 m con 1 juego de poleas desde pluma principal SSL. Plumín fijo: tramo de pie 9 m, parte superior plumín 9 m. Longitud de plumín: 18 m. Longitudes de pluma principal: 114-144 m. Ángulos: 20°.
SWSL	Pluma principal: igual que SSL. Inclínable de 88° a 45°. Plumín abatible: tramo de pie 10 m, tramos intermedios 6 m y 12 m, cabeza de carga pesada 2 m con 1 juego de poleas desde pluma principal SSL. Equipamiento Superlift. Longitudes de pluma principal: 54-120 m. Longitudes de plumín: 36-120 m.
SFSL	Igual que SWSL. Ángulo de plumín 15°.
SFVL	Pluma principal: igual que SSL. Plumín fijo: tramo de pie 10 m, cabeza de carga pesada 2 m con 2 juegos de poleas desde pluma principal SSL. Equipamiento Superlift. Longitudes de pluma principal: 54-120 m. Longitud de plumín: 12 m. Ángulos: 15°.
Fijación de la pluma	Fijación de tramos de pluma por pernos asistidos hidráulicamente de serie.
Cabestrante pasador	Montado en superestructura de serie.
Dispositivos de seguridad	Indicador electrónico de carga, interruptor de límite de cabestrante, interruptor de límite de elevación para movimientos de pluma, retén hidráulico de pluma, anemómetro.

Configuraciones Superlift

Tele-SL	Mástil 50 m (tipo 2621), bandeja de contrapeso 640 t o 800 t o carro de contrapeso para máx. 640 t opcional. Radio de Superlift en progresión continua durante la operación: 19 m a 25 m con un radio de mástil de 22 m y 24 m a 30 m con un radio de mástil de 26,4 m.
----------------	---

Equipamiento opcional

Carro de contrapeso	El carro de contrapeso con un peso total de 640 t se puede ajustar libremente de 19 m a 25 m o de 24 m a 30 m desde el centro de rotación, y puede operarse en los modos de avance de vía circular, seguimiento y $\pm 30^\circ$ en paralelo. El peso propio de 130 t se divide en tres componentes para un transporte sencillo.
Contrapesos Superlift	
Equipo Runner 3 m – 70 t	Para 2 ramales, montado en pluma principal o cabezales de plumín. Distancia a juego de poleas en posición empinada de pluma aprox. 1,3 m. Capacidad de elevación: máx. 70 t.
Cabestrante H3	Montado en la superestructura.
Sistema de extinción de incendios	Sistema automático de extinción de incendios incl. contraventanas en contenedor.
Sistema de detección de incendios	Solo detección.
Litera en cabina	Litera plegable.
Asientos plegables en cabina	Dos asientos plegables en cabina.
Protección contra caídas	Para pluma principal, plumín y mástil SL.
Bandeja Superlift 800 t	
Kit potenciador de pluma Boom Booster	Detalles a petición.
Kit TWIN	Detalles a petición.

Veículo sobre esteiras

	<p>Veículo de 5 seções formado pela torre de rotação, dois eixos transversais e dois chassis separados para as esteiras. A torre de rotação, os eixos transversais e os chassis separados são conectados por pinos de ação hidráulica.</p> <p>Largura das esteiras: 10,5 m.</p>
Torre de rotação	<p>Estrutura soldada resistente a flexão e torção fabricada com aço estrutural de granulação fina e alta resistência. Conexões de desengate rápido (opcionais) facilitam a retirada do anel de giro da torre de rotação para diminuir o peso no transporte.</p>
Eixos transversais	<p>Estrutura soldada resistente a flexão e torção fabricada com aço estrutural de granulação fina e alta resistência incluindo as pernas do macaco hidráulico.</p>
Estruturas laterais das esteiras	<p>Estrutura soldada resistente a flexão e torção fabricada com aço estrutural de granulação fina e alta resistência. Chassis laterais do tipo separado para diminuir o peso no transporte. Lubrificação centralizada como item de série.</p>
Esteiras	<p>Sapatas da esteira de aço tratado de alta resistência. 15 roletes por esteira com superfícies de rolamento temperadas.</p>
Tração	<p>As esteiras são comandadas por dois motores hidráulicos cada, através de caixas fechadas com engrenagens planetárias em banho de óleo, equipadas com freios de retenção com liberação hidráulica por ação de mola. Cada esteira oferece controle independente infinitamente variável e capacidade de contrarotação. Tração quádrupla como item de série.</p>
Unidade de giro	<p>Quatro caixas de engrenagens na torre de rotação comandadas por motores hidráulicos através de unidades planetárias fechadas em banho de óleo. Freio de retenção com liberação hidráulica por ação de mola e frenagem hidráulica sem desgaste.</p>

Superestrutura

Contrapeso	<p>295 t em combinação com 60 t de lastro central.</p>
Chassi	<p>Estrutura soldada resistente à flexão fabricada com aço estrutural de granulação fina e alta resistência. Construção sobre longarinas acomoda três tambores de cabos e o guincho da lança. Superestrutura de tipo separado facilita o transporte.</p>
Módulo de energia e controle	<p>Duas unidades de acionamento independentes, incluindo a caixa de engrenagens de distribuição para as bombas e as próprias bombas, estão localizadas em um módulo separado, que se conecta à lateral da superestrutura. A energia vem de dois motores a diesel Mercedes-Benz tipo OM 471 LA. Potência: 390 kW (523 HP) a 1700 rpm, torque de 2460 Nm a 1300 rpm cada. Os motores atendem os requisitos das norma de emissões EU Stage IV / EPA Tier 4f. O sistema vem com aditivo Ad-Blue e conversor catalítico SCR.</p> <p>Opcional para mercados não regulamentados: Motor a diesel Mercedes-Benz tipo OM 502 LA. Potência: 390 kW (523 HP) a 1800 rpm, torque de 2400 Nm a 1300 rpm cada. Os motores atendem os requisitos das norma de emissões EU Stage III A / EPA Tier 3.</p> <p>Caixa de engrenagens de distribuição para as bombas com cinco bombas de pistão axial com deslocamento variável e bombas de engrenagens. O módulo padrão de energia e controle inclui cabine, sistema elétrico completo e geradores. Capacidade do tanque de combustível: 2000 l.</p>
Tambores dos cabos de aço	<p>O equipamento padrão na superestrutura consiste de três tambores para cabos de aço – guincho 1, guincho 2 e guincho da lança. Os tambores dos cabos são tracionados por unidades fechadas de engrenagens planetárias em banho de óleo. Todos os tambores contam com freios multidisco de liberação hidráulica e frenagem hidráulica sem desgaste para a descida das cargas. As pontas dos cabos em todos os tambores estão equipadas com acessórios de engate rápido. Guinchos H1 e H2 (H3 opcional) com pinagem hidráulica podem ser removidos para diminuir o peso no transporte.</p>
Sistema de controle	<p>IC-1: Controle eletrônico proporcional do piloto da válvula integrado ao sistema de controle por programa armazenado incluindo diagnósticos. Dois monitores coloridos, indicador de carga operado através de tela de toque. Velocidades de trabalho infinitamente variáveis, controladas pela posição da alavanca. Controle automático de potência para máxima utilização do rendimento do motor. Indicador de limitação do alcance de trabalho padrão e pressão sobre o solo.</p>
Cabine	<p>Cabine espaçosa e confortável situada na parte dianteira do módulo de potência. Grande vidraça laminada para a janela dianteira e o teto solar, ar condicionado controlado por computador como item de série e unidade autônoma de calefação. O console dianteiro contém controles da instrumentação e do guindaste além de dois mostradores gráficos. Ele pode se inclinar para trás junto com o assento do operador, melhorando sua visão da ponta da lança. Sistemas de câmeras para monitoração dos tambores de cabos e lastro do SL, horímetro, indicador de momento de carga, dois faróis de trabalho, compartimentos com tampa e refrigerador incluídos como itens de série.</p>
Equipamentos elétricos	<p>Sistema de 24 V (2 baterias de 12 V / 180 Ah). Alternador trifásico de 24 V e 80 A. Mais gerador trifásico de 400 V, 50 Hz, 20 kVA para ar condicionado, calefação, iluminação e uso múltiplo no canteiro. Gerador de emergência de 400 V, 50 Hz, 16 kVA.</p>
Conexão rápida	<p>Conexões hidráulicas de desengate rápido na superestrutura e no veículo como itens de série.</p>

Configurações da lança

Geral	Estrutura treliçada com corda tubular fabricada com aço estrutural de granulação fina e alta resistência. Passarelas na lança principal, lança auxiliar e torre. Pinagem hidráulica.
SSL	Lança principal: seção do pé 10 m, inserções 6 m e 12 m, cabeça da lança 2 m com moitões duplos. Equipamento Superlift. Comprimentos da lança principal: 54-120 m.
HSSL	Lança principal: Usando as seções pesadas da lança principal SSL de 108 m. Equipamento Superlift. Comprimentos da lança principal: 48-84 m.
SSL / LSL (SGL 108 m)	Lança principal: seção do pé 10 m, inserções 6 m e 12 m, alongada por inserções de 6 m e 12 m, topo para carga pesada 2 m com moitão da lança principal SSL. Equipamento Superlift. Comprimentos da lança principal: 114-156 m.
SSL / LSL+LF S2	Lança principal: seção do pé 10 m, inserções 6 m e 12 m, alongada por inserções de 6 m e 12 m, topo para carga pesada 2 m com moitão da lança principal SSL. Lança auxiliar fixa: seção do pé 9 m, seção de topo da lança auxiliar 9 m. Comprimento da lança auxiliar: 18 m. Comprimentos da lança principal: 114-144 m. Inclinação: 20°.
SWSL	Lança principal: igual à SSL. Inclinação 88° a 45°. Lança auxiliar articulada: seção do pé 10 m, inserções de 6 m e 12 m, topo para carga pesada 2 m com 1 moitão da lança principal SSL. Equipamento Superlift. Comprimentos da lança principal: 54-120 m. Comprimentos da lança auxiliar: 36-120 m.
SFSL	Igual à SWSL. Lança auxiliar articulada 15°.
SFVL	Lança principal: igual à SSL. Lança auxiliar fixa: seção do pé 10 m, topo para carga pesada 2 m com 2 moitões da lança principal SSL. Equipamento Superlift. Comprimentos da lança principal: 54-120 m. Comprimento da lança auxiliar: 12 m. Inclinação: 15°.
Pinagem da lança	Pinagem hidráulica assistida das seções da lança como característica de série.
Guincho de passagem	Montada sobre superestrutura como característica de série.
Equipamentos de segurança	Indicador eletrônico de carga, chave limitadora do guincho, chaves limitadoras dos movimentos da lança, batentes hidráulicos da lança, anemômetro.

Superlift configurations

Tele-SL	Mastro 50 m (tipo 2621), base do contrapeso 640 t ou 800 t ou veículo do contrapeso para máx. 640 t opcional. Raio da Superlift infinitamente variável durante a operação: 19 m a 25 m com raio do mastro de 22 m e 24 m a 30m com raio do mastro de 26,4 m.
----------------	--

Equipamentos opcionais

Veículo dos contrapesos	O veículo do contrapeso, com peso máximo total de 640 t, pode ser regulado para distâncias de 19 a 25 m ou 24 a 30 m do centro de rotação e operado nos modos de trajetória circular, posterior e em posição paralela a $\pm 30^\circ$. Sobrecarga de 130 t, distribuída em três componentes para facilitar o transporte.
Contrapesos do Superlift	
Ponta de montagem 3 m – 70 t	Para 2 linhas, montada na cabeça da lança principal ou da auxiliar. Distância até o moitão em posição de lança elevada aprox. 1,3 m. Capacidade de içamento: máx. 70 t.
Guincho H3	Montado na superestrutura.
Sistema de supressão de fogo	Sistema automático de supressão de fogo com venezianas no contêiner.
Sistema de detecção de incêndio	Somente detecção.
Beliche na cabine	Beliche dobrável.
Assentos dobráveis na cabine	Dois conjuntos dobráveis na cabine.
Proteção contra quedas	Para lança principal, auxiliar e mastro do SL.
Plataforma do Superlift 800 t	
Kit do ampliador da lança	Detalhes sob consulta.
Kit TWIN	Detalhes sob consulta.

Гусеничное шасси

	5-секционное шасси крана с кузовом, двумя поперечными осями и двумя разборными боковыми рамами гусениц. Кузов, поперечные оси и боковые рамы гусениц соединяются штифтами с помощью гидравлики. Ширина колеи: 10,5 м.
Корпус	Сварная конструкция из устойчивой к изгибу и кручению высокопрочной мелкозернистой конструкционной стали. Быстроразъемные фитинги (опция) облегчают снятие опорно-поворотного круга кузова для снижения веса при транспортировке.
Поперечные оси	Сварная конструкция прочная на изгиб и скручивание, изготовленная из высокопрочной мелкозернистой конструкционной стали, включающая опоры гидравлических домкратов.
Боковые стенки шасси	Сварная конструкция из устойчивой к изгибу и кручению высокопрочной мелкозернистой конструкционной стали. Разъемные боковые рамы гусениц для уменьшения веса при транспортировке. Система централизованной смазки входит в стандартную комплектацию.
Гусеницы	Звенья гусеничной цепи сделаны из закаленной высокопрочной литой стали. 15 катков с закаленной поверхностью качения на каждую гусеницу.
Привод	Каждая гусеница приводится в движение двумя гидравлическими двигателями через планетарный редуктор в закрытом корпусе с масляной ванной, каждый двигатель имеет подпружиненный гидравлический тормоз-замедлитель. Управление гусеницами независимое с бесступенчатой регулировкой и с режимом противовращения. Квадропривод в стандартной комплектации.
Поворотный механизм	Четыре коробки передач поворотного механизма, приводимого в движение гидравлическими двигателями через планетарный редуктор в закрытом корпусе с масляной ванной. Подпружиненный тормоз с гидроусилителем и неизнашивающийся гидравлический тормоз.

Надстройка

Противовес	295 т с учетом 60 т центрального балласта.
Рама	Сварная конструкция прочная на изгиб и скручивание, изготовленная из высокопрочной мелкозернистой конструкционной стали. Продольная балочная конструкция для размещения трех тросовых барабанов и лебедки стрелы. Разборная надстройка для облегчения транспортировки.
Блок силового агрегата и управления	<p>Два независимых привода, включающих распределительную коробку насосов и насосы, помещаются в отдельном модуле, который устанавливается сбоку надстройки. Источником энергии для приводов служит дизельный двигатель Mercedes-Benz типа OM 471 LA. Выходная мощность: 390 кВт (523 л.с.) при 1700 об/мин, вращающий момент 2460 Нм при 1300 об/мин; Двигатель соответствует требованиям стандарт выбросов EU Stage IV / EPA Tier 4f. Система оснащена топливной системой Ad-Blue с каталитическим нейтрализатором SCR.</p> <p>Опционально для нерегулируемых рынков: дизельный двигатель Mercedes-Benz, типа OM 502 LA. Выходная мощность: 390 кВт (523 л.с.) при 1800 об/мин, вращающий момент 2400 Нм при 1300 об/мин, каждый. Двигатель соответствует требованиям стандарт выбросов EU Stage III A / EPA Tier 3.</p> <p>Раздаточная коробка насосов с пятью поршневыми насосами с регулированием объема и шестеренными насосами. Блок силового агрегата и управления в стандартной комплектации включает кабину, полный комплект электрического оборудования и электрические генераторы. Емкость топливного бака: 2000 л.</p>
Канатные барабаны	Стандартный набор оборудования надстройки включает три тросовых барабана – лебедок 1 и 2 и лебедки стрелы. Усилие на тросовые барабаны передается через планетарные редукторы в закрытом корпусе с масляной ванной. Все тросовые барабаны оборудованы многодисковыми гидравлическими тормозами и неизнашивающимися гидравлическими тормозами для управления опусканием груза. Концы тросов на всех барабанах имеют быстроразъемные соединительные концевые фитинги. Лебедки H1 и H2 (в качестве опции H3) соединяются штифтами при помощи гидравлики и для снижения веса при перевозке могут сниматься.
Система управления	IS-1: Заложена в установленную программу управления, включающую диагностику, система электронного пропорционального управления через регулирующие клапаны. Два цветных монитора, индикатор нагрузки, управляемый через сенсорный экран. Бесступенчатая регулировка рабочих скоростей изменением положения рычага. Автоматическая регулировка мощности для оптимизации выходной мощности двигателя. Ограничитель рабочего диапазона и индикатор давления на грунт входят в стандартную комплектацию.
Кабина	Просторная удобная кабина расположена в передней части блока силового агрегата. Стандартная комплектация включает большие окна из многослойного стекла спереди и сверху, управляемую компьютером систему кондиционирования и автономный воздушный обогреватель. Передняя консоль включает приборы и органы управления краном, а также два графических дисплея. Она откидывается назад вместе с сиденьем оператора для улучшения обзора конца стрелы. Система видеокамер для контроля тросовых барабанов и балласта SL (системы Superlift), счетчик времени наработки, индикатор момента нагрузки, два рабочих прожектора, отсеки для вещей и холодильник входят в стандартную комплектацию.
Электрическое оборудование	Система с напряжением 24 В (2 аккумулятора 12 В/180 А-ч). 3-фазный генератор переменного тока, 24 В, 80 А. Плюс 3-фазный генератор переменного тока 400 В, 50 Гц, 20 кВА для питания кондиционера, обогревателя, освещения и для использования для других целей на рабочей площадке. Аварийный генератор 400 В, 50 Гц, 16 кВА.
Быстроразъемное соединение	Гидравлические быстроразъемные фитинги на надстройке и шасси в стандартной комплектации.

Варианты конфигурации стрел S и L

Общая	Решетчатая трубная конструкция, изготовленная из высокопрочной мелкозернистой конструкционной стали. Ступеньки на мачтах главной стрелы, гуська и мачты. Гидравлическая система соединения штифтами.
SSL	Главная стрела: нижняя секция 10 м, вставки 6 и 12 м, головка стрелы 2 м с 2 комплектами шкивов. Оборудование суперлифт. Главная стрела: 54-120 м.
HSSL	Главная стрела: использует тяжелые секции основной стрелы SSL 108 м. Оборудование суперлифт. Главная стрела: 48-84 м.
SSL / LSL (SGL 108 m)	Главная стрела: нижняя секция 10 м, вставки 6 и 12 м, удлиняющие вставки гуська 6 и 12 м, головка для тяжеловесов 2 м с 1 комплектом шкивов основной стрелы SSL. Оборудование суперлифт. Главная стрела: 114-156 м.
SSL / LSL+LF S2	Главная стрела: нижняя секция 10 м, вставки 6 и 12 м, удлиняющие вставки гуська 6 и 12 м, головка для тяжеловесов 2 м с 1 комплектом шкивов основной стрелы SSL. Неподвижная стрела с изменяемым вылетом: нижняя секция 9 м, верхняя секция вспомогательной стрелы 9 м. Длина вспомогательной стрелы: 18 м. Главная стрела: 114-144 м. Угол смещения: 20°.
SWSL	Главная стрела: идентична SSL. Угол смещения 88°-45°. Стрела с изменяемым вылетом и гуськом нижняя секция 10 м, вставки 6 и 12 м, головка для тяжеловесов 2 м с 1 комплектом шкивов главной стрелы SSL. Оборудование суперлифт. Главная стрела: 54-120 м. Длина вспомогательной стрелы: 36-120 м.
SFSL	идентична SWSL. Угол смещения гуська 15°.
SFVL	Главная стрела: идентична SSL. Неподвижная стрела с изменяемым вылетом: нижняя секция 10 м, головка для тяжеловесов 2 м с 2 комплектами шкивов главной стрелы SSL. Оборудование суперлифт. Главная стрела: 54-120 м. Длина вспомогательной стрелы: 12 м. Угол смещения: 15°.
Соединение штифтами стрелы	Гидравлическая система соединения штифтами главной стрелы в стандартной комплектации.
Запасовочная лебедка	Устанавливается на надстройке в стандартной комплектации.
Дополнительные устройства	Электронный индикатор нагрузки, ограничитель лебедки, ограничители движения стрелы, гидравлические ограничители обратного хода стрелы, анемометр.

КОНФИГУРАЦИИ СИСТЕМЫ СУПЕРЛИФТ

Tele-SL	Мачта 50 м (тип 2621), платформа тягача для перевозки противовесов 640 т или 800 т или тягач для перевозки противовесов на макс. вес 640 т в качестве дополнительной опции. Бесступенчатая регулировка радиуса системы суперлифт во время работы: 19-25 м с радиусом мачты 22 и 24 м и 24-30 м с радиусом мачты 26,4 м.
----------------	---

Дополнительное оборудование

Платформа для перевозки противовесов	Тягач с платформой для перевозки противовесов с макс. общей грузоподъемностью 640 т регулируется по длине с вариантами 19-25 м или 24-30 м от оси сочленения, платформа может проходить поворот, строго следуя по пути тягача или с заносом хвостовой части ± 30° от прямой, двигаясь параллельно дороге. Собственная масса 130 т, для облегчения транспортировки разбирается на три части.
Противовесы системы суперлифт	
Комплект оборудования подвижного блока 3 м 3 м – 70 т	На два троса, устанавливается на головках основной стрелы или гуська. Расстояние до шкива при стреле, установленной под острым углом приблизительно 1,3 м. Грузоподъемность: макс. 70 т.
Лебедка H3	Установлена на надстройке.
Система пожаротушения	Автоматическая система пожаротушения, включающая ставни на контейнере.
Система пожарной сигнализации	Только сигнализация.
Койка в кабине	Складная койка в кабине.
Складные сиденья в кабине	Два складных сиденья в кабине.
Защита от падения с высоты	На основной стреле, вспомогательной стреле и мачте SL.
Платформа для противовесов Superlift 800 т	
Комплект для удлинения и повышения грузоподъемности стрелы	Подробные данные по запросу.
Комплект оборудования для спаренной стрелы	Подробные данные по запросу.

Anmerkungen zu den Tragfähigkeiten · Conditions d'utilisation · Annotazioni sulle portate · Condiciones de utilización · Notas sobre capacidade de içamento · Примечания по грузоподъемности

Ratings are in compliance with ISO 4305.

Weight of hook blocks and slings is part of the load, and is to be deducted from the capacity ratings.

Consult operation manual for further details.

Note: Data published herein is intended as a guide only and shall not be construed to warrant applicability for lifting purposes. Crane operation is subject to the computer charts and operation manual both supplied with the crane.

In some instances the superlift counterweight does not lift off the ground with the indicated load.

Tragfähigkeiten entsprechen ISO 4305.

Das Gewicht der Unterflaschen, sowie die Lastaufnahmemittel, sind Bestandteile der Last und sind von den Tragfähigkeitsangaben abzuziehen.

Weitere Angaben in der Bedienungsanleitung des Kranes.

Anmerkung: Die Daten dieser Broschüre dienen nur zur allgemeinen Information; für ihre Richtigkeit übernehmen wir keine Haftung. Der Betrieb des Kranes ist nur mit den Original-Tragfähigkeitstabellen und mit der Bedienungsanleitung zulässig, die mit dem Kran mitgeliefert werden.

In einigen Fällen hebt das Superliftgegengewicht bei den angegebenen Traglasten nicht ab.

Le tableau de charges est conforme à la norme ISO 4305.

Les poids du crochet-moufle et de tous les accessoires d'élingage font partie de la charge et sont à déduire des charges indiquées.

Pour plus de détails consulter la notice d'utilisation de la grue.

Nota : Les renseignements ci-inclus sont donnés à titre indicatif et ne représentent aucune garantie d'utilisation pour les opérations de levage. La mise en service de la grue n'est autorisée qu'à condition que les tableaux de charges ainsi que le manuel de service, tels que fournis avec la grue, soient observés.

Le contrepoids du superlift ne décolle pas dans certaines configurations des tableaux de charge.

Le portate sono conformi alla norma ISO 4305.

Il peso del bozzello e delle funi d'attacco fanno parte del carico e sono quindi da detrarre dai valori di tabella.

Per ulteriori dettagli sulla velocità vento, consultare il manuale di istruzione della gru.

Nota: I dati riportati su tale prospetto sono solo a titolo indicativo e pertanto non impegnativi. L'impiego della gru è ammesso solo rispettando le tabelle originali ed il manuale di uso fornito assieme alla gru.

In alcuni casi, con il carico indicato, il contrappeso Superlift non si solleva dal suolo.

Las capacidades de carga están sujetas a las normas ISO 4305.

El peso de los ganchos y eslingas son parte de la carga y serán deducidos de las capacidades brutas.

Consultar los manuales de operación para ampliar información.

Observación: Los datos publicados son solamente orientativos y no se deben interpretar como garantía de aplicación para determinadas operaciones de elevación. La manipulación de la grúa está sujeta a las cargas programadas en el ordenador y en el manual de operaciones, ambos suministrados con la grúa.

En algunos casos, el contrapeso superlift no se eleva del suelo con la carga indicada.

Valores nominais de acordo com a ISO 4305.

O peso dos moitões e eslingas faz parte da carga e tem de ser subtraído das capacidades nominais.

Consultar manual de operação para outros detalhes.

Nota: Os dados publicados aqui destinam-se a simples orientação e não devem ser interpretados como garantia de aplicabilidade para fins de içamento. A operação da grua depende de tabelas de computador e do manual de operação, ambos fornecidos com a máquina.

Em alguns casos, o contrapeso do Superlift não levanta do solo com a carga indicada.

Номинальные значения соответствуют ISO 4305.

Вес крюкоблока и строп является частью груза и должен вычитаться из номинальных значений грузоподъемности.

Подробности см. в руководстве по эксплуатации.

Примечание. Публикуемые в настоящем издании данные приводятся только для справки и не должны использоваться при расчете нагрузки. При эксплуатации крана должны применяться компьютерные таблицы и руководство по эксплуатации, входящие в комплект поставки крана.

В некоторых случаях противовес системы суперлифт не может быть поднят с земли с указанной нагрузкой.

Notes

CC 8800-1

Notizen · Notes · Nota · Notas · Notas ·
пометы, комментарии, примечания

A large rectangular area with horizontal lines, intended for taking notes.

October 2019. Product specifications and prices are subject to change without notice or obligation. The photographs and/or drawings in this document are for illustrative purposes only. Refer to the appropriate Operator's Manual for instructions on the proper use of this equipment. Failure to follow the corresponding Operator's Manual when using our equipment or to otherwise act responsibly may result in serious injury or death. The only warranty applicable to our equipment is the standard written warranty applicable to the particular product and sale and Demag makes no other warranty, express or implied. All rights reserved. Products and services listed may be trademarks, service marks or trade-names of Demag IP Holdings GmbH.

Oktober 2019. Irrtum und Änderungen der Produktspezifikationen vorbehalten. Die in diesem Dokument enthaltenen Fotos und/oder Zeichnungen dienen rein anschaulichen Zwecken. Für den sachgemäßen Gebrauch der Maschinen ist das entsprechende Bedienerhandbuch heranzuziehen. Unsachgemäßer Umgang mit bzw. unsachgemäßer Einsatz unserer Maschinen kann zu schweren gesundheitlichen Schäden bis hin zum Tod führen. Für unsere Produkte wird ausschließlich die entsprechende, schriftlich niedergelegte Standardgarantie gewährt. Demag leistet keinerlei darüber hinausgehende Garantie, weder ausdrücklich noch stillschweigend. Alle Rechte vorbehalten. Die genannten Produkte und Dienstleistungen sind ggf. Marken, Dienstleistungsmarken oder Handelsnamen der Demag IP Holdings GmbH.

Octobre 2019. Les caractéristiques et prix des produits peuvent faire l'objet de modifications sans notification préalable. Les photographies et/ou schémas présentés dans le présent document sont communiqués à titre purement informatif. Pour connaître les instructions relatives à l'utilisation correcte de cet équipement, veuillez vous référer au manuel de l'utilisateur correspondant. Le non-respect du manuel d'utilisateur correspondant lors de l'utilisation de notre équipement ou des actes irresponsables risquent de provoquer de graves blessures, voire un décès. La seule garantie applicable à nos équipements est la garantie écrite standard applicable au produit et à la vente spécifiques. Demag ne délivre aucune autre garantie, expresse ou implicite. Tous droits réservés. Les produits et les services mentionnés peuvent être des marques de commerce, des marques de service ou des appellations commerciales de Demag IP Holdings GmbH.

Ottobre 2019. Ci riserviamo il diritto di modificare le caratteristiche tecniche ed i prezzi dei prodotti in ogni momento e senza obbligo di preavviso. Le fotografie e gli schemi presentati in questo documento sono forniti unicamente a scopo illustrativo. Consulta il Manuale dell'operatore per trovare istruzioni per l'utilizzo corretto di questo macchinario. La mancata osservanza delle istruzioni contenute nel Manuale dell'operatore durante l'uso del macchinario e altri comportamenti irresponsabili possono provocare gravi lesioni, anche mortali. L'unica garanzia applicabile ai nostri macchinari è la garanzia scritta standard applicabile al particolare prodotto e alla particolare vendita e Demag non dà alcuna altra garanzia, esplicita o implicita. Tutti i diritti riservati. I prodotti e servizi elencati possono essere dei marchi di fabbrica, marchi di servizio o nomi commerciali di Demag IP Holdings GmbH.

Octubre 2019. Los precios y las especificaciones de los productos pueden sufrir cambios sin previo aviso ni obligación. Las fotografías y/o dibujos de este documento tienen un fin meramente ilustrativo. Consulte el correspondiente manual de instrucciones del operador para obtener más información sobre el uso correcto de esta maquinaria. El hecho de no respetar el correspondiente manual del operador al utilizar la maquinaria o de actuar de forma irresponsable, puede provocar lesiones graves o mortales. La única garantía aplicable a nuestra maquinaria es la garantía escrita estándar correspondiente a cada producto y venta, y Demag no amplía dicha garantía de forma expresa ni implícita. Todos los derechos reservados. Los productos y servicios mencionados pueden ser marcas comerciales, marcas de servicio o nombres de marca de Demag IP Holdings GmbH.

Outubro 2019. As especificações e os preços dos produtos estão sujeitos a alteração sem nenhuma obrigação ou prévio aviso. As fotografias e/ou desenhos neste documento são apenas para fins ilustrativos. Consulte o respectivo Manual do Operador para instruções sobre o uso correto deste equipamento. Deixar de acompanhar o respectivo Manual do Operador ao usar o nosso equipamento ou, de qualquer outra forma, deixar de agir de maneira responsável pode resultar em lesões corporais graves ou morte. A única garantia aplicável ao nosso equipamento é a garantia padrão por escrito correspondente ao produto vendido. A Demag não dá outras garantias, expressas ou implícitas. Todos os direitos reservados. Os produtos e serviços indicados podem ser marcas comerciais, marcas de serviço ou nomes comerciais da Demag IP Holdings GmbH.

Октябрь 2019 г. Технические характеристики и цены могут изменяться без предварительного уведомления и без каких-либо обязательств для производителя. Фотографии и (или) чертежи в настоящем документе служат только в качестве иллюстраций. Инструкции по надлежащей эксплуатации данного оборудования см. в соответствующем руководстве для оператора. Невыполнение указаний соответствующих руководств для оператора при эксплуатации оборудования или другие безответственные действия могут повлечь серьезные травмы или смерть. Единственной гарантией, действующей в отношении нашего оборудования, является стандартная форма письменной гарантии на данный тип оборудования и на условия его продажи. Demag не дает никаких других гарантий: ни ясно выраженных, ни подразумеваемых. Все права защищены. Перечисленные продукты и услуги могут быть товарными знаками, знаками обслуживания или торговыми наименованиями Demag IP Holdings GmbH.

© Tadano Demag GmbH 2019. Demag is a trademark of Tadano Demag GmbH.

DEMAG
TADANO GROUP

Tadano Demag GmbH
Europa Allee 2
66482 Zweibrücken
Germany
T +49 6332 830

www.demagmobilecranes.com



Tadano Ltd. (International Division)
4-12, Kamezawa 2-chome
Sumida-ku Tokyo 130-0014, Japan
E info@tadano.com T 81-3-3621-7750
www.tadano.com